



Steam oven HMT85D.53.



BOSCH

[en] Instruction manual

Safety precautions	4	Tables and tips	16
Safety notes	4	Accessories	16
Causes of damage	4	Cookware	16
Your new appliance	5	Cooking time and quantity.....	16
Control panel	5	Distributing food evenly.....	16
Cooking compartment.....	6	Pressure-sensitive food	16
Accessories	6	Cooking a menu	16
Automatic calibration	6	Vegetables	16
Before using for the first time	6	Side dishes and pulses.....	17
Setting the clock	6	Poultry and meat.....	17
Setting the water hardness range	6	Fish	18
Before first use	7	Soup vegetables, miscellaneous.....	18
Cleaning the accessories before use	7	Dessert, compote	19
Operating the appliance	7	Reheating food.....	19
Filling the water tank	7	Defrosting.....	19
Switching on the appliance.....	8	Proving dough.....	20
Switching off the appliance.....	9	Juicing.....	20
After each use	9	Preserving	20
Changing the clock time	9	Frozen products.....	20
Automatic programmes	9		
Setting a programme	9		
Notes about the programmes	10		
Programme table	10		
Basic settings	11		
Care and cleaning	12		
Cleaning agents	12		
Descaling.....	13		
Troubleshooting	14		
Changing the door seal.....	15		
Replacing the cooking compartment bulb	15		
After-sales service	15		
E number and FD number	15		
Environmental protection	16		
Environmental protection.....	16		
Tips for saving energy	16		

Additional information on products, accessories, replacement parts and services can be found at www.bosch-home.com and in the online shop www.bosch-eshop.com

Safety precautions

Read these instructions for use carefully. Please keep the instructions for use and installation instructions in a safe place. If the appliance changes owners, the instructions should always be included.

Safety notes

This appliance is intended for domestic use only. This appliance must only be used for food preparation.

Adults and children must not operate the appliance without supervision,

- if they are physically or mentally incapable of doing so or
- if they have insufficient knowledge or experience.

Never let children play with the appliance.

Risk of injury!

Do not open the appliance door if the appliance is not integrated or securely fastened with screws. It can tip or fall off the unit. Observe the assembly instructions.

Risk of scalding!

Hot steam may escape when the appliance door is opened. Open the appliance door carefully during or after cooking. When opening, do not stand too close to the appliance. Ensure that, depending on the temperature, steam is not visible.

Risk of burns!

Never touch the interior surfaces of the cooking compartment or the heating elements when they are hot. Small children must be kept at a safe distance from the appliance.

Risk of fire!

Never store combustible items in the cooking compartment.

Risk of scalding!

Never pour water into the cooking compartment when it is hot. This will create hot steam.

Risk of short circuit!

Never trap connecting cables of electrical appliances in the hot appliance door. The cable insulation could melt.

Risk of burning!

Never prepare food containing large quantities of drinks with a high alcohol content. Alcoholic vapours can catch fire in the cooking compartment. Only use small quantities of drinks with a high alcohol content and take care when opening the appliance door.

Risk of burning!

Never remove hot accessories or ovenware from the cooking compartment without oven gloves.

Risk of scalding!

Do not clean the appliance immediately after switching it off. The water in the evaporator dish is still hot. Wait until the appliance has cooled down.

Risk of electric shock!

Incorrect repairs are dangerous. Repairs may only be carried out by one of our trained after-sales engineers. If the appliance is defective, pull out the mains plug or switch off the appliance at the circuit breaker in the fuse box. Call the after-sales service.

Causes of damage

Caution!

- Do not place anything on the cooking compartment floor. Do not cover it with aluminium foil. A build-up of heat could damage the appliance.
The cooking compartment floor and the evaporator dish must always be kept clear. Always place ovenware in a perforated cooking container or on a wire rack.
- Aluminium foil in the cooking compartment must not come into contact with the door panel. This could cause permanent discolouration of the door panel.
- Ovenware must be heat and steam resistant.
- Do not use ovenware that shows signs of rust. Even the smallest spots of rust can lead to corrosion in the cooking compartment.
- When steaming with a perforated cooking container, always insert the baking tray or the solid cooking container underneath. Dripping liquid is caught.
- Do not store moist food in the closed cooking compartment for long periods. It can lead to corrosion in the cooking compartment.
- Fruit juice may leave stains in the cooking compartment. Always remove fruit juice immediately and wipe the cooking compartment with a moist and dry cloth.
- If the door seal is very dirty, the appliance door will no longer close properly during operation. The fronts of adjacent units could be damaged. Always keep the door seal clean and replace when necessary.
- The cooking compartment in your appliance is made of high grade stainless steel. Improper care can lead to corrosion in the cooking compartment. Refer to the care and cleaning instructions in the instruction manual. Remove food residues from the cooking compartment as soon as the appliance has cooled.

Your new appliance

In this section, you will find information on

- the control panel
- the cooking compartment

- accessories
- automatic calibration

Control panel

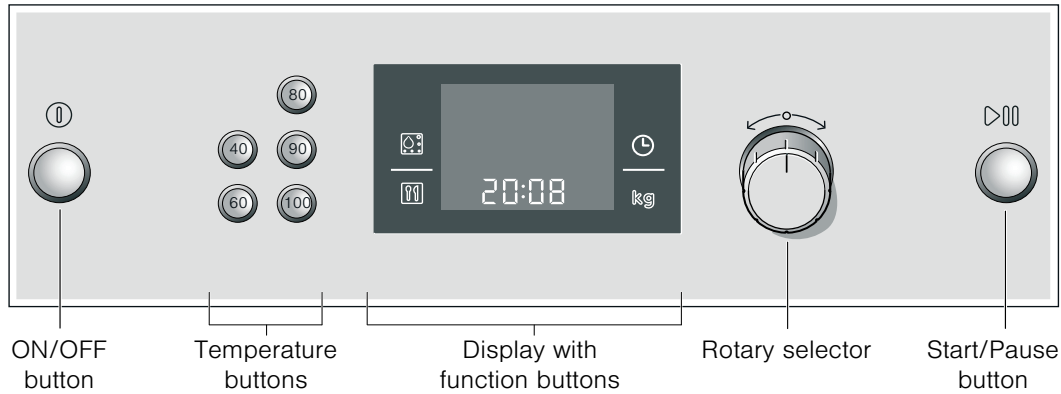

Control / display		Use / meaning
On/off button	ⓘ	Switching the appliance on and off
Temperature buttons	40	Steams at 40 °C, e.g. for proving dough and defrosting
	60	Steams at 60 °C, e.g. for defrosting
	80	Steams at 80 °C, e.g. for fish and sausages
	90	Steams at 90 °C, e.g. for fish, sausages and extra soup ingredients
	100	Steams at 100 °C, e.g. for vegetables, fish, meat and side dishes, for juice extraction and preserving
(For more information about dishes and meals, see section: Tables and tips)		
Descaling function button	☒	Descaling the water system and the evaporator dish (see section: Descale)
Programme function button	☒	Selects the automatic programmes (see section: Automatic programmes)
Clock function button	🕒	Appliance switched on Setting the cooking time [🕒]
		Appliance switched off Short press: changes the time [🕒] Press and hold: changes the basic settings
Weight function button	kg	Sets the weight of the food for a programme
Descal display	☒	The ☒ indicator prompts you to descale the appliance (see section: Descaling)
Fill water tank indicator	☒	The ☒ indicator prompts you to fill the water tank (see section: Filling the water tank)
Display Empty evaporator dish	☒	During descaling, the ☒ indicator prompts you to remove the remaining water from the evaporator dish using the cleaning sponge supplied
Rotary selector		Sets the value in the display
		The rotary selector is retractable. Press on the rotary selector to pop it in our out
Start/pause button	▶⏸	Short press: starts and stops operation (pause)
		Press and hold: ends operation

Cooking compartment

Press the  symbol to open the appliance door.

The cooking compartment has three shelf positions. The shelf positions are counted from the bottom up.

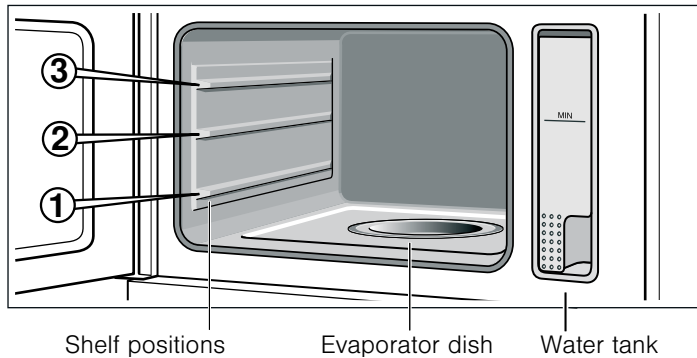

Use the enclosed cleaning sponge to empty the evaporator dish after every cooking operation. Otherwise, the dish may overflow during the next cooking operation.

Caution!

Do not place anything on the cooking compartment floor. Do not cover it with aluminium foil. A build-up of heat could damage the appliance.

The cooking compartment floor and the evaporator dish must always be kept clear. Always place ovenware in a perforated cooking container or on a wire rack.

Accessories

Use only the accessories supplied with the product or available from the after-sales service. They are specially designed for your appliance.

Your appliance is equipped with the following accessories:



Cooking container, solid, GN 1/2, 40 mm deep
for catching dripping liquid when steaming and for cooking rice, pulses and cereals.

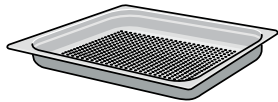

Cooking container, perforated, GN 1/2, 40 mm deep
for the steaming of whole fish or large quantities of vegetables, for juicing berries, etc.

You can obtain further accessories from specialist retailers:

Accessories	Order no.
Cooking container, solid, GN 1/2, 40 mm deep	HEZ36D253
Cooking container, perforated, GN 1/2, 40 mm deep	HEZ36D253G
Cooking container, solid, GN 1/3, 40 mm deep	HEZ36D153
Cooking container, perforated, GN 1/3, 40 mm deep	HEZ36D153G
Cleaning sponge	643 254
Descaler	311 138
Honeycomb microfibre cloth	460 770

Automatic calibration

The boiling temperature of water depends on the air pressure. During calibration, the appliance is adapted to the pressure conditions in the location where it is installed. This happens automatically when you first use the appliance (see section: First use). More steam develops than usual.

It is important that the appliance steams without interruption for 20 minutes at 100 °C. Do not open the appliance door during this time.

If the appliance was not able to calibrate itself automatically (for example, because the appliance door was opened), the calibration process is carried out again during the next cooking operation.

After moving house

So that the appliance automatically adjusts itself to its new location, you must reset the appliance to the factory settings (see section: Basic settings) and repeat the initial start-up process (see section: First use).

After a power cut

The appliance saves the calibration settings even in the event of a power cut or disconnection from the mains. Recalibration is not necessary.

Before using for the first time

In this section you will find out which steps are required before using the appliance for the first time:

- setting the clock
- changing the water hardness range if required
- before first use
- cleaning the accessories before use

Your appliance was thoroughly factory tested for proper operation. As a result, there may already be a small amount of condensation in the appliance.

Setting the clock

After the power has been connected, the  symbol and **00:00** light up in the display.

1. Set the current time using the rotary selector.
2. Press the  button.
The current time is applied.

Setting the water hardness range

Descal your appliance regularly. This is the only way to prevent damage.



Your appliance automatically displays when it needs descaling. It has been preset to water hardness range "medium". Change the value if your water is softer or harder.

You can check the water hardness with the test strips supplied or ask your water supplier.

If your water is very hard, we recommend that you use softened water.

You can only dispense with descaling completely if you exclusively use softened water. If this is the case, change the water hardness to "softened".

You can change the water hardness range in the basic settings when the appliance is switched off.

1. If required, press the  button to switch off the appliance.
2. Press and hold the  button until **ε / /** appears in the display.

3. Press the  button repeatedly until **cS 2** appears (water hardness range "medium").

4. Turn the rotary selector to change the water hardness range.
Possible values:

cS 0	softened	-
cS 1	soft	I
cS 2	medium	II
cS 3	hard	III
cS 4	very hard	IV

5. Press and hold the  button to exit basic settings.
The change is saved.

Before first use

Before first use, heat the empty appliance for 20 minutes at 100 °C. Do not open the appliance door during this time. The appliance is automatically calibrated (see section: Automatic calibration).

1. Press the  button to switch on the appliance.

2. Fill the water tank and insert it (see section: Filling the water tank).

3. Press the  button.

The appliance heats up to 100 °C. The cooking time (20 minutes) does not start to count down until the set temperature has been reached. Do not open the appliance door during this time.

The cooking operation automatically ends and a signal sounds.

4. Press the  button to switch off the appliance.

Leave the appliance door ajar until the appliance has cooled down.

Cleaning the accessories before use

Using soapy water and a soft cloth, clean the accessories thoroughly before first use.

Operating the appliance

In this section, you can read about

- how to fill the water tank
- how to switch the appliance on and off
- what to note after each use
- how to change the clock time

Filling the water tank

Press the  symbol to open the appliance door. You can see the water tank on the right.

Caution!

Use of unsuitable liquids may damage the appliance

- Only use fresh tap water, softened water or uncarbonated mineral water.
- If your tap water is very hard, we recommend that you use softened water.
- Do not use distilled water, highly chlorinated tap water (> 40 mg/l) or other liquids.

You can obtain information about your tap water from your water supplier. The water hardness can be checked with the test strips enclosed.

Fill the water tank before each use:

1. Open the appliance door and take out the water tank.
2. Fill the water tank with cold water.

MIN	Amount of water required for approx. 30 minutes steaming at 100 °C
MAX	Amount of water required for approx. 2 hours steaming at 100 °C

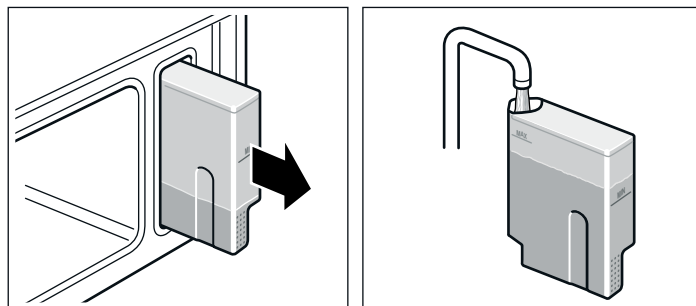

3. Slide in the water tank and push it in using the textured area on the bottom until it engages.

Switching on the appliance

1. Press the  button to switch on the appliance.

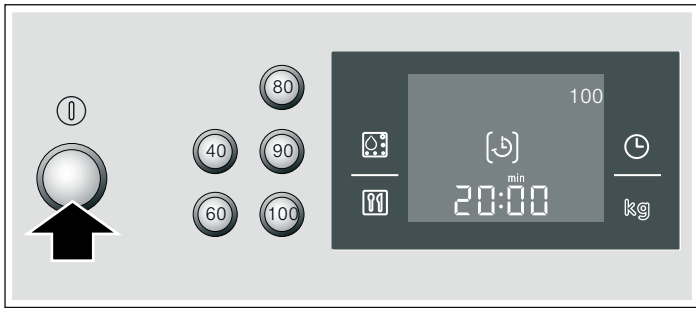

The preferred temperature of 100° and the preferred cooking time [⏸] of 20 minutes appears in the display.

2. Press the temperature button to select a temperature (for more information about dishes and meals, see section: Tables and tips).

Button	Used for	Default cooking time
40 °C	e.g. for proving dough and defrosting	30 minutes
60 °C	e.g. for defrosting	20 minutes
80 °C	e.g. for fish and sausages	20 minutes
90 °C	e.g. for fish, sausages and extra soup ingredients	20 minutes
100 °C	e.g. vegetables, fish, meat and side dishes, for juice extraction and preserving	20 minutes

The appropriate default time appears in the display.



3. Turn the rotary selector to set a cooking time (max. 2 h).



4. Press the  button.

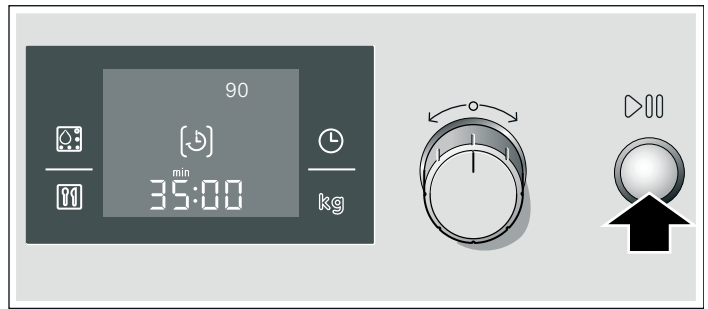

The appliance heats up.

The cooking time does not start counting down until after the heating-up time.

Changing the temperature

You can change the temperature at any time. To do this, press the required temperature button:

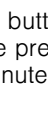

- If you have selected a lower temperature, the cooking time continues counting down without interruption.
- If you have selected a higher temperature, the cooking time does not continue counting down until after the heating-up time.

If you press a temperature button twice, the current cooking operation is cancelled. The preferred temperature of 100 °C and cooking time of 20 minutes appear in the display. Press the  button to start.

Changing the cooking time

You can change the cooking time at any time. Turn the rotary selector to set a new cooking time. After a few seconds, the change is automatically adopted.

Stops (pauses) operation

Press the  button briefly to pause operation. The cooling fan may continue to run. To start, press the  button again briefly.

If you open the appliance door during operation, this pauses operation. To start, close the appliance door and press the  button briefly. If you have switched on the basic setting "Continue operation after closing door", restarting is not required (see section: Basic settings).

Fill water tank indicator

If the water tank is empty, a signal sounds and the  symbol appears. Operation is stopped.

1. Open the appliance door carefully. Steam will escape.

2. Remove the water tank, fill it with water and reinsert it.

3. Press the  button briefly.

If you have switched on the basic setting "Continue operation after closing door", restarting is not required (see section: Basic settings).

Note: If there is no more water in the tank, you will hear a loud pumping sound until the evaporator dish has boiled dry. Only then will  appear and the signal will sound.

When this happens, pause cooking and refill the tank (see: Pausing operation).

Switching off the appliance

Risk of scalding!

Hot steam may escape when the appliance door is opened. Open the appliance door carefully during or after cooking. When opening, do not stand too close to the appliance. Ensure that, depending on the temperature, steam is not visible. Press and hold the  button to cancel the cooking operation.

When the cooking time has finished, the cooking operation automatically ends and a signal sounds.

Press the  button to switch off the appliance. Open the appliance door carefully.

The cooling fan may continue running when you open the appliance door.

After each use

Emptying the water tank.

Empty the water tank after each use:

1. Pull the water tank out of the appliance slowly, keeping it horizontal, so that no remaining water can drip out of the valve.
2. Empty out the water.
3. Thoroughly dry the water tank and the tank recess in the appliance.

Drying the cooking compartment

Risk of scalding!

The water in the evaporator dish may still be hot. Allow it to cool before wiping.

Leave the appliance door ajar until the appliance has cooled down.

Use the enclosed cleaning sponge to empty the evaporator dish after every cooking operation. Otherwise, the dish may overflow during the next cooking operation.

Wipe the cooled cooking compartment and the evaporator dish with the enclosed sponge and dry well with a soft cloth.

Wipe units and handles dry where condensation has built up.

Changing the clock time

No cooking time should be set.

1. Press the  button.

The  symbol appears in the display.

2. Change the time with the rotary selector.

3. Press the  button.

The change is applied.

You can hide the clock. It is then only visible when the appliance is switched on (see section: Basic Settings).

Automatic programmes



You can prepare food really easily with 20 different programmes.

In this section, you will find out

- how to set one of the automatic programmes
- hints and tips on the programmes
- which programmes you can set

Setting a programme

Select the correct programme from the programme table. Follow the instructions for the programmes.

1. Press the  button to switch on the appliance.
2. Press the  button.
The first programme  appears in the display.



3. Turn the rotary selector to set the required programme.



4. Press the  button.

A default weight appears in the display.

If a signal sounds, you do not need to enter a weight for this programme.

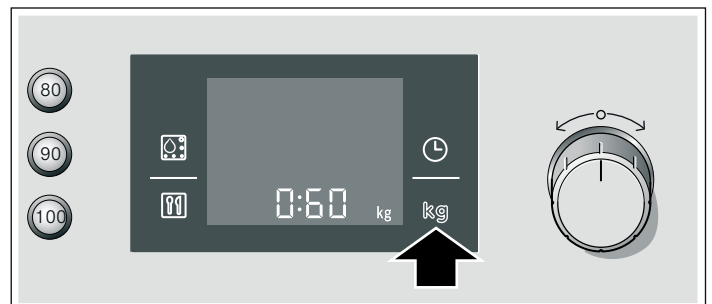

5. Turn the rotary selector to enter the weight of the items to be cooked.



6. Press the button.
The programme cooking time counts down in the display.

End of the programme

A signal sounds. Cooking has finished. Press the button to switch off the appliance.

Risk of scalding!

Hot steam may escape when the appliance door is opened. Open the appliance door carefully during or after cooking. When opening, do not stand too close to the appliance. Ensure that, depending on the temperature, steam is not visible.

Cancelling the programme

Press the button to cancel the programme and switch off the appliance.

Notes about the programmes

All programmes are designed for cooking on one level.
The cooking result can vary according to the size and quality of the food.

Ovenware

Use the suggested ovenware. All meals have been tested using this ovenware. The cooking result may change if you use different ovenware.

When cooking in the perforated cooking container, also insert the solid cooking container at level 1. Dripping liquid is caught.

Amount/ weight

Do not fill the food more than 4 cm deep in the accessories.
The automatic programmes require the weight of the food. The total weight must be within the specified weight range.

Cooking time

After the programme is started the cooking time is displayed. It may change during the first 10 minutes, as the heating-up time depends, among other things, on the temperature of the food and the water.

Preparing vegetables P01 - P05

Do not season vegetables until after cooking.

Preparing cereal products/lentils P07 - P10

Weigh the food and add the correct ratio of water:

Basmati rice 1:1.5

Couscous 1:1

Brown rice 1:1.5

Lentils 1:2

Enter the weight excluding liquid.

Stir cereal products after cooking. The remaining water is then quickly absorbed.

Steam chicken breast P11

Do not place chicken breasts on top of each other in the ovenware.

Steam fish P12 - P13

When preparing fish, grease the perforated cooking container.

Do not place fish fillets on top of one another. Enter the weight of the heaviest fillet and select pieces as similar in size as possible.

Prepare fruit compote P14

The programme is only suitable for fruits with stones and pips. Weigh the fruit and add approximately 100 ml of water, and add sugar and spices according to taste.

Prepare rice pudding P15

Weigh the rice and add 2.5 times the amount of milk. Ensure the level of rice and milk in the accessory is no higher than 2.5 cm. Enter the weight of the rice pudding excluding liquid. Stir after cooking. The remaining milk is quickly absorbed.

Prepare yoghurt P16

Heat the milk to 90 °C on the hob. Then leave to cool to 40 °C. If you are using UHT milk, you do not need to heat it.

Stir in one to two teaspoons of natural yoghurt per 100 ml milk, or the corresponding amount of yoghurt culture into the milk. Pour the mixture into clean jars and seal them.

After preparation, leave the glass jars to cool in the refrigerator.

Sterilise bottles P18

Always clean the bottles with a bottle brush immediately after drinking. Then clean them in the dishwasher.

Place the bottles in the perforated cooking container so that they do not touch one another.

Dry the bottles with a clean cloth after sterilising. The process corresponds to normal sterilisation by boiling.

Cook eggs P19 - P20

Pierce the eggs before cooking. Do not place eggs on top of each other. Size M corresponds to a unit weight of approx. 50 g.

Programme table

In this section you will find all the programmes for your steam oven. Follow the instructions for the programmes.

Programme	Remarks	Ovenware/accessories	Level	
P 1	Steam cauliflower florets	florets of equal size	perforated + solid cooking container	2 1
P 2	Steam broccoli florets	florets of equal size	perforated + solid cooking container	2 1
P 3	Steam green beans	-	perforated + solid cooking container	2 1
P 4	Sliced carrots, steam	slices, approx. 3 mm thick	perforated + solid cooking container	2 1
P 5	Steam frozen mixed vegetables	-	perforated + solid cooking container	2 1
P 6	Unpeeled boiled potatoes	medium-sized, 4 - 5 cm thick	perforated + solid cooking container	2 1
P 7	Basmati rice	max. 0.45 kg	solid cooking container	2

Programme	Remarks	Ovenware/accessories	Level
P 8	Brown rice	max. 0.45 kg	solid cooking container 2
P 9	Couscous	max. 0.45 kg	solid cooking container 2
P 10	Lentils	max. 0.4 kg	solid cooking container 2
P 11	Steam fresh chicken breast	total weight 0.2 - 1.2 kg	perforated + solid cooking container 2 1
P 12	Steam whole, fresh fish	0.3 - 1.5 kg	perforated + solid cooking container 2 1
P 13	Steam fresh fish fillet	max. 2.5 cm thick	perforated + solid cooking container 2 1
P 14	Fruit compote	-	solid cooking container 2
P 15	Rice pudding	-	solid cooking container 2
P 16	Yogurt in glass jars	-	jars + solid cooking container 2
P 17	Reheat cooked side dishes		solid cooking container 2
P 18	Sterilise bottles		solid cooking container 1
P 19	Hard-boiled eggs	eggs, size M, max. 1 kg	perforated + solid cooking container 2 1
P 20	Soft-boiled eggs	eggs, size M, max. 1 kg	perforated + solid cooking container 2 1

Basic settings

Your appliance has various basic settings, which are preset at the factory. You can, however, change these basic settings as required.

If you want to cancel all the changes, you can restore the factory settings.

1. If required, press the $\text{\textcircled{1}}$ button to switch off the appliance.
2. Press and hold the $\text{\textcircled{2}}$ button until **c 1 1** appears in the display.

3. Press the $\text{\textcircled{3}}$ button until the desired basic setting appears.

4. Turn the rotary selector to change the basic setting.

5. Press and hold the $\text{\textcircled{4}}$ button to exit basic settings. The change is saved.

You can change the following basic settings:

Basic setting	Function	Possible settings
c 1 1	Displays the clock when the appliance is switched off	c 1 0 = off c 1 1 = on
c 2 1	Acoustic signal when a button is pressed	c 2 0 = off c 2 1 = on
c 3 2	Length of the acoustic signal at the end of an operation	c 3 1 = short (30 seconds) c 3 2 = medium (2 minutes) c 3 3 = long (10 minutes)
c 4 1	Continues operation after the door is closed. The operation does not go back to the beginning when the appliance door is opened	c 4 0 = off c 4 1 = on
c 5 2	Water hardness range for the descaling indicator	c 5 0 = softened c 5 1 = soft (I) c 5 2 = medium (II) c 5 3 = hard (III) c 5 4 = very hard (IV)
c 6 1	Acoustic signal for the end of the heating-up time	c 6 0 = off c 6 1 = on

Basic setting	Function	Possible settings
c 7 1	Adjust the cooking results in the programmes individually	c 7 1 = cooked normally c 7 2 = less thoroughly cooked c 7 3 = more thoroughly cooked
c 8 0	Restore the appliance to the factory settings: <ul style="list-style-type: none"> ■ all changes to the basic settings are deleted ■ automatic calibration is carried out again <p>The appliance is restored to the factory setting if you select c 8 1 and then press and hold the ⏻ button for 4 seconds.</p>	c 8 0 = do not restore c 8 1 = restore

Care and cleaning

In this section, you will find information on

- the care and cleaning of your appliance
- Descaling

Risk of short circuit!

Do not use high-pressure cleaners or steam jet cleaners to clean your appliance.

Caution!

Risk of surface damage: Do not use

- harsh or abrasive cleaning agents
- oven cleaners
- corrosive or aggressive cleaners, or those containing chlorine
- cleaning agents with a high alcohol content

If such an agent comes into contact with the front of the appliance, wash it off immediately with water.

Caution!

Risk of surface damage: If descaler comes into contact with the front of the appliance or any other sensitive surfaces, wash it off immediately with water.

Remove food residues from the cooking compartment as soon as the appliance has cooled.

Salts are very corrosive and can cause rust. Remove remains of acidic sauces (ketchup, mustard) or salted food from the cooking compartment immediately after cooling.

Do not use hard scouring pads or cleaning sponges.

Cleaning agents

Appliance exterior (stainless steel front)	Use soapy water and dry with a soft cloth. Always remove any flecks of limescale, grease, starch and albumin (e.g. egg white) immediately. Special stainless steel cleaning agents can be obtained from the after-sales service or from specialist retailers.
Cooking compartment interior with evaporator dish	Hot soapy water or a vinegar solution. Use the enclosed cleaning sponge or a soft washing-up brush. Caution! <ul style="list-style-type: none"> ■ Damage to the appliance: The water flows through a hose via the cooking compartment floor into the evaporator dish. When cleaning, ensure that you do not exert any pressure on the water inlet or catch it on something behind it. The hose could be squeezed out of the cooking compartment. In this case, you must call the after-sales service. Do not use the appliance. ■ The cooking compartment could rust.: Do not use steel pads or scourers
Water tank	Soapy water. Do not put through the dishwasher! The lid of the water tank can be carefully removed for cleaning
Tank recess	Rub dry after every use
Door seal	Hot soapy water
Door panels	Glass cleaner Caution! Risk of surface damage: After cleaning, wipe the door panels with glass cleaner, then dry. Otherwise, stains will be caused that will not be able to be removed.
Inside of the door (plastic cover)	Use soapy water and dry with a soft cloth. Always remove any flecks of limescale, grease, starch and albumin (e.g. egg white) immediately.
Accessories	Soak in hot soapy water. Clean with a washing-up brush or sponge or in the dishwasher. Clean stains caused by starchy food (e.g. rice) with a vinegar solution

Cleaning sponge

The enclosed cleaning sponge is very absorbent. Use the cleaning sponge only for cleaning the cooking compartment and for removing residual water from the evaporator dish.

Wash the cleaning sponge thoroughly before using for the first time. You can wash the cleaning sponge in the washing machine (hot wash).

Microfibre cloth

The honeycomb microfibre cloth is particularly suitable for cleaning sensitive surfaces such as glass, glass ceramic, stainless steel or aluminium (product no. 460 770, also available from our online eShop). It removes liquid and greasy deposits in one go.

Descaling

The appliance must be descaled at regular intervals in order for it to continue operating correctly. The  indicator reminds you to do this.

You can only dispense with descaling completely if you exclusively use softened water.

The descaling operation consists of:

- Descal (approx. 30 minutes), then refill the water tank and empty the evaporator dish
- 1st rinse (30 seconds) and then empty the evaporator dish
- 2nd rinse (30 seconds) and then remove the remaining water

All three steps must be completed in full. The appliance is ready for operation again only after the 2nd rinse.

Descaler

Only use the liquid descaler recommended by the after-sales service for descaling (product no. 311138, also available online from the eShop). Other descalers may damage the appliance.

1. Prepare a descaling solution by mixing 300 ml water and 60 ml liquid descaler.
2. Empty the water tank and fill with descaling solution.
3. Carefully slide in the water tank with the descaling solution and close the appliance door.

Caution!





Risk of surface damage: If descaler comes into contact with the front of the appliance or any other sensitive surfaces, wash it off immediately with water.

Caution!



Damage to the appliance: If descaler is in the appliance for a prolonged period, this may damage the water pump. Ensure that the descaling and rinsing cycles take no longer than three hours to complete.



Starting descaling

The cooking compartment must have cooled down completely.



1. Press the  button to switch on the appliance.
2. Press the  button.
The  symbol (Fill water tank) appears. This is to remind you to fill the water tank with the descaling solution (see section: Descaler).
3. Press the  button.





1st rinse

A signal sounds after approx. 30 minutes. The  symbol (Fill water tank) and  min are displayed.

1. Rinse the water tank thoroughly, fill with water until the MIN mark and reinsert.
The  symbol (empty evaporator dish) appears.
2. Remove the descaling solution from the evaporator dish using the cleaning sponge supplied.
3. Close the appliance door and press the  button.
The appliance starts rinsing.

2nd rinse

After a short time, the  symbol appears again.  min appears in the display.



1. Thoroughly rinse out the cleaning sponge.
2. Remove the remaining water from the evaporator dish using the cleaning sponge.
3. Close the appliance door and press the  button.
The appliance starts rinsing.
Once descaling is complete,  and  appear in the display.
4. Press the  button to finish descaling, and switch off the appliance.

Removing the remaining water

Remove the remaining water from the evaporator dish using the cleaning sponge. Wipe out the cooking compartment using the cleaning sponge and then dry with a soft cloth.

Cancelling the descaling

Note: After cancelling the descaling, you must rinse the appliance twice. The appliance is locked against other applications until the second rinsing operation is complete.

1. Press and hold the  button to cancel the descaling process.
To ensure that no descaling solution remains in the appliance, it must be rinsed twice after a cancellation.
2. Press the  button.
The  symbol appears.

Now proceed as described in the "1st rinse" section.

Troubleshooting

Malfunctions often have simple explanations. Please read the following instructions before calling the after-sales service.

Repairs may only be carried out by fully trained after-sales service technicians. Incorrect repairs to your appliance may present considerable risks for the user.

Risk of electric shock!

- Work on the appliance electronics may only be performed by a specialist.
- Always disconnect the appliance from the power supply when work is carried out on the electronics. Switch off the circuit breaker or remove the fuse from your household fuse box.

Problem	Possible cause	Notes/remedy
The appliance does not work	The plug is not plugged into the mains	Connect the appliance to the electricity supply
	Power cut	Check whether other kitchen appliances are working
	Fuse defective	Check in the fuse box to make sure that the fuse for the appliance is OK
	Faulty operation	Switch the appliance off using the fuse in the fuse box. Wait approximately 10 seconds and then switch it back on
The appliance cannot be started	The appliance door is not fully closed	Close the appliance door
Appliance does not start. [🌀] and 1:00 min appear in the display	Descaling has been cancelled	Rinse the appliance twice (see section: Cancelling descaling)
[🕒] and 00:00 lights up in the display	Power cut	Reset the clock (see section: Changing the clock time)
The appliance is not in operation. [🌀] and a cooking time lights up in the display	The rotary selector was accidentally operated	Press the [🕒] button
	The [▶] button was not pressed after making the setting	Press the [▶] button to start the appliance, or press the [🕒] button to turn it off
The [🚰] (Fill water tank) indicator appears, even though the water tank is full	The water tank has not been inserted properly	Slide in the water tank until it engages
	The detection system is not working	Descal the appliance (see section: Descaling) and check which water hardness has been set (see section: Setting the water hardness range)
It is difficult to engage the water tank in position	Rubber seal on the water tank valve	Lightly grease the rubber seal with lubricant (order no. 311 168)
The evaporator dish has boiled empty even though the water tank is full	The water tank has not been inserted properly	Slide in the water tank until it engages
	The feed line is blocked	Descal the appliance (see section: Descaling). Check whether the water hardness range is set correctly
The evaporator dish is overflowing	The evaporator dish was not emptied after the last cooking operation	Use the enclosed cleaning sponge to empty the evaporator dish after every cooking operation
Extremely loud pumping sound during cooking	Water tank is empty, but water is still evaporating in the evaporator dish	Filling the water tank
	The water tank has not been inserted properly	Slide in the water tank until it engages
Pumping sound during cooking		This is normal
There is a "pop" noise during cooking	Cold/warm effect with frozen food, caused by the steam	This is normal
When you cook with steam, a lot of steam is created	The appliance is being automatically calibrated	This is normal (see section: Automatic calibration)
When cooking with steam, there is again a lot of steam	The appliance is unable to calibrate itself automatically if cooking times are too short	Restore the appliance to factory settings (see section: Basic settings) and recalibrate the appliance (see section: Before first use)
Steam escapes from the ventilation slots during cooking		This is normal

Problem	Possible cause	Notes/remedy
The appliance is not producing steam properly	Limescale has formed in the appliance	Start the descaling programme.
Hose for the water inlet in the cooking compartment was pushed to the side or has hooked itself to the side of the cooking compartment wall.	Strong pressure on the hose or hooking of objects when cleaning	Call after-sales service and do not use the appliance.
Cooking compartment light has failed	The LED lamp is defective	Contact the after-sales service. The glass light cover cannot be removed
An E ... error message appears in the display	Technical fault	Press the ⏻ button to delete the error message. Reset the clock if required. If the error message appears again, call the after-sales service
The error message EO !! appears in the display	A button was pressed for too long or is jammed	Press the ⏻ button to delete the error message Press all of the buttons individually and check if they are clean
The appliance is not heating. The colon flashes in the display	A button combination was actuated	Press the ⏻ button to switch off the appliance. Press and hold the kg button for 4 seconds, then press the ⏻ button

Changing the door seal

If the seal around the outside of the cooking compartment is faulty, it must be replaced. Replacement seals for your appliance can be obtained from the after-sales service. Please specify the E number and FD number of your appliance.

1. Open the appliance door.
2. Pull off the old seal.
3. Push in the new door seal at one point and pull it in all the way round. The joint must be at the side.
4. Check again that the seal is correctly fitted in the corners.

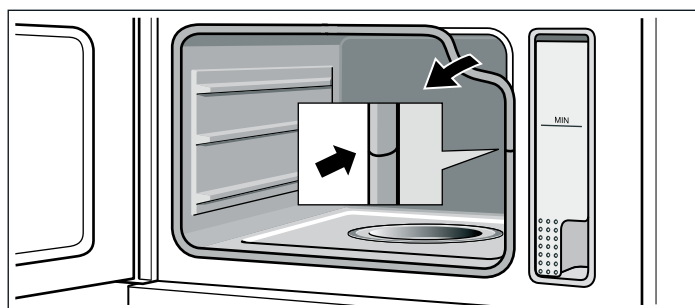

Replacing the cooking compartment bulb

The cooking compartment light in your appliance is a durable LED light. If a fault does occur in the LED light, contact the after-sales service. The glass light cover must not be removed

After-sales service

Our after-sales service is there for you if your appliance needs to be repaired. We will always find the right solution in order to avoid unnecessary visits from a service technician.

E number and FD number

When calling us, please give the product number (E no.) and the production number (FD no.) so that we can provide you with the correct advice. The rating plate bearing these numbers can be found on the lower left-hand side when you open the appliance door.

You can make a note of the numbers of your appliance and the telephone number of the after-sales service in the space below to save time should it be required.

E no. _____ **FD no.** _____

After-sales service ☎

Please note that there will be a fee for a visit by a service technician in the event of a malfunction, even during the warranty period.

Please find the contact data of all countries in the enclosed customer service list.

To book an engineer visit and product advice

GB 0844 8928979
Calls from a BT landline will be charged at up to 3 pence per minute. A call set-up fee of up to 6 pence may apply.

IE 01450 2655

Trust the expertise of the manufacturer, and rest assured that the repair will be carried out by trained service technicians using original spare parts for your domestic appliance.

Environmental protection

Unpack the appliance and dispose of the packaging in an environmentally-responsible manner.

Environmental protection



This appliance is labelled in accordance with the European Directive 2002/96/EU concerning used electrical and electronic appliances (WEEE – waste electrical and electronic equipment). The guideline determines the framework for the return and recycling of used appliances as applicable.

Tips for saving energy

- Only preheat the appliance if this is specified in the recipe or in the operating instructions table.
- Open the appliance door as infrequently as possible while the food is cooking.
- When steaming, you can cook on several levels at the same time. When preparing foods with different cooking times, those with the longest cooking time should be placed in the oven first.

Tables and tips

Steaming is a particularly gentle way of cooking food. The steam surrounds the dish thereby preventing a loss of nutrients from the food. Cooking takes place without overpressure. As a result, the shape, colour and typical aroma of the dishes are retained.

The tables contain a selection of dishes which are particularly suitable for your steam oven. You can find out which temperature, accessories and cooking time to select. Unless otherwise stated, the information given applies to inserting accessories when the appliance is cold.

Accessories

Use the accessories provided.

When steaming in the perforated cooking container, always insert the solid cooking container underneath. Dripping liquid is caught.

Cookware

When using ovenware, always place it in the middle of the perforated cooking container.

Ovenware must be heat and steam resistant. Cooking times are increased if thick-walled ovenware is used.

Food which would normally be prepared in a bain marie should always be covered with foil (e.g. when melting chocolate).

Vegetables

Place the vegetables in the perforated cooking container and insert at level 2. Always insert the solid cooking container underneath at level 1. Dripping liquid is caught.

Cooking time and quantity

The cooking times when steaming depend on the item size, but do not depend on the total quantity. The appliance can steam food to a maximum of 1.5 kg.

Follow the unit sizes given in the tables. The cooking time is reduced for smaller pieces and increased for larger ones. Cooking time is also influenced by the quality and ripeness of the food. The values quoted can therefore only serve as a guideline.

Distributing food evenly

Always distribute the food evenly in the ovenware. It will not cook evenly if the layers are of different depths.

Pressure-sensitive food

When layering delicate foods in the cooking container, do not pile them too high. It is better to use two containers.

Cooking a menu

With steam, you can cook a whole menu at once, without the different flavours mixing. Place the food with the longest cooking time in the appliance first and delay the rest until the appropriate time. This means that all the food will be ready at the same time.

The overall cooking time is extended with menu cooking, as a little steam escapes each time the appliance door is opened and has to be reheated.

Food	Size	Accessories	Temperature in °C	Cooking time in min.
Artichokes	whole	perforated + solid	100	30 - 35
Cauliflower	whole	perforated + solid	100	25 - 30
Cauliflower	florets	perforated + solid	100	10 - 15
Broccoli	florets	perforated + solid	100	8 - 10
Peas	-	perforated + solid	100	5 - 10
Fennel	slices	perforated + solid	100	10 - 14
Vegetable flan	-	Bain marie 1.5 l + perforated cooking container at level 1	100	60 - 70

* Preheat the appliance

Food	Size	Accessories	Temperature in °C	Cooking time in min.
Green beans	-	perforated + solid	100	20 - 25
Carrots	slices	perforated + solid	100	10 - 20
Kohlrabi	slices	perforated + solid	100	15 - 20
Leeks	slices	perforated + solid	100	4 - 6
Corn on the cob	-	perforated + solid	100	25 - 35
Swiss chard	shredded	perforated + solid	100*	8 - 10
Green asparagus	whole	perforated + solid	100*	12 - 15
White asparagus	whole	perforated + solid	100*	15 - 20
Spinach	-	perforated + solid	100*	2 - 3
Romanesco	florets	perforated + solid	100	8 - 10
Brussels sprouts	florets	perforated + solid	100	20 - 30
Beetroot	whole	perforated + solid	100	40 - 50
Red cabbage	shredded	perforated + solid	100	30 - 35
White cabbage	shredded	perforated + solid	100	25 - 35
Courgettes	slices	perforated + solid	100	2 - 3
Mangetout	-	perforated + solid	100	8 - 12

* Preheat the appliance

Side dishes and pulses

Add water or liquid in the proportion specified. For example:
1:1.5 = add 150 ml liquid for every 100 g rice.

You may select any shelf position you wish for the solid cooking container.

Food	Ratio/ information	Accessories	Level	Temperature in °C	Cooking time in min.
Unpeeled boiled potatoes	medium size	perforated + solid	2 1	100	35 - 45
Boiled potatoes	quartered	perforated + solid	2 1	100	20 - 25
Brown rice	1:1.5	solid	-	100	30 - 40
Long grain rice	1:1.5	solid	-	100	20 - 30
Basmati rice	1:1.5	solid	-	100	15 - 20
Parboiled rice	1:1.5	solid	-	100	15 - 20
Risotto	1:2	solid	2	100	30 - 35
Lentils	1:2	solid	-	100	30 - 45
Canellini beans, pre-softened	1:2	solid	-	100	65 - 75
Couscous	1:1	solid	-	100	6 - 10
Unripe spelt grain, coarse ground	1:2.5	solid	-	100	15 - 20
Millet, whole	1:2.5	solid	-	100	25 - 35
Wheat, whole	1:1	solid	-	100	60 - 70
Dumplings	-	perforated + solid	2 1	90	25 - 30

Poultry and meat

Poultry

Food	Amount/ weight	Accessories	Level	Temperature in °C	Cooking time in min.
Chicken breast	per 0.15 kg	solid	2	100	15 - 25
Duck breast*	per 0.35 kg	solid	2	100	12 - 18

* Sear first and wrap in foil

Beef

Food	Amount/ weight	Accessories	Level	Temperature in °C	Cooking time in min.
Thin slice of sirloin, medium*	1 kg	solid	2	100	25 - 35
Thick piece of sirloin, medium*	1 kg	solid	2	100	30 - 40

* Sear first and wrap in foil

Pork

Food	Amount/ weight	Accessories	Level	Temperature in °C	Cooking time in min.
Fillet of pork*	0.5 kg	solid	2	100	10 - 12
Pork medallions*	approx. 3 cm thick	solid	2	100	10 - 12
Smoked pork ribs	sliced	solid	2	100	15 - 20

* Sear first and wrap in foil

Sausages

Food	Accessories	Level	Temperature in °C	Cooking time in min.
Wiener sausages	perforated + solid	2 1	80 - 90	12 - 18
Bavarian veal sausages	perforated + solid	2 1	80 - 90	15 - 20

Fish

Food	Amount/weight	Accessories	Level	Temperature in °C	Cooking time in min.
Sea bream, whole	per 0.3 kg	perforated + solid	2 1	80 - 90	15 - 25
Sea bream fillet	per 0.15 kg	perforated + solid	2 1	80 - 90	10 - 20
Fish terrine	Bain marie 1.5 l	solid	2	80 - 100	40 - 80
Trout, whole	per 0.2 kg	perforated + solid	2 1	80 - 90	12 - 15
Cod fillet	per 0.15 kg	perforated + solid	2 1	80 - 90	10 - 14
Salmon fillet	per 0.15 kg	perforated + solid	2 1	100	8 - 10
Mussels	1.5 kg	solid	2	100	10 - 15
Ocean perch fillet	per 0.15 kg	perforated + solid	2 1	80 - 90	10 - 20
Sole rolls, stuffed		perforated + solid	2 1	80 - 90	10 - 20

Soup vegetables, miscellaneous

Food	Accessories	Level	Temperature in °C	Cooking time in min.
Royale	solid	2	90	15 - 20
Semolina dumplings	perforated + solid	2 1	90	7 - 10
Hard-boiled eggs (Size M, max. 1.8 kg)	perforated + solid	2 1	100	10 - 12
Soft-boiled eggs (Size M, max. 1 kg)	perforated + solid	2 1	100	6 - 8

Dessert, compote

Compote:

Weigh the fruit and add approximately 100 ml of water, and add sugar and spices according to taste.

Rice pudding

Weigh the rice and add 2.5 times the amount of milk. Ensure the level of rice and milk in the accessory is no higher than 2.5 cm. Stir after cooking. The remaining milk is quickly absorbed.

Food	Accessories	Temperature in °C	Cooking time in min.
Yeast dumplings	solid cooking container	100	20 - 25
Crème caramel	mould + perforated cooking container	90	20 - 25
Rice pudding*	solid cooking container	100	25 - 35
Apple compote	solid cooking container	100	10 - 15
Pear compote	solid cooking container	100	10 - 15
Cherry compote	solid cooking container	100	10 - 15
Rhubarb compote	solid cooking container	100	10 - 15
Plum compote	solid cooking container	100	15 - 20

* You can also use the programme **P 15** (see section: Automatic programmes)

Reheating food

Using Reheat, dishes can be gently reheated with steam. They taste and look like they have been freshly prepared.

Food	Accessories	Level	Temperature in °C	Cooking time in min.
Vegetables	solid cooking container	2	100	12 - 15
Pasta, potatoes, rice	solid cooking container	2	100	5 - 10

Defrosting

When freezing, lay the food as flat as possible and in portion-sized pieces at -18 °C. Do not freeze excessively large quantities. Once defrosted, food will not keep for as long and spoils more quickly than fresh food.

Leave the food to defrost in the freezer bag, on a plate or on the perforated cooking container. Always insert the solid cooking container underneath. The food is then not left lying in the defrost water and the cooking compartment remains clean.

If necessary, the meal can occasionally be split apart or pieces which have already defrosted can be removed from the appliance.

After defrosting, allow the food to stand for a further 5 - 15 minutes to come up to room temperature.

Health risk!

When defrosting food from animal sources, you must remove the liquid that escapes during defrosting. It must never come into contact with other food. Bacteria could be transferred.

After defrosting, operate the steam oven for 15 minutes at 100 °C.

Defrost meat

Allow pieces of meat which are to be breadcrumbed to defrost to the point where seasoning and breadcrumbs adhere to the meat.

Defrosting poultry

Remove from packaging before defrosting. You must tip the defrost liquid away.

Food	Amount/weight	Accessories	Level	Temperature in °C	Cooking time in min.
Chicken	1 kg	perforated + solid	2 1	40	90 - 110
Chicken drumsticks	0.4 kg	perforated + solid	2 1	40	60 - 70
Vegetables frozen in blocks (e.g. spinach)	0.4 kg	perforated + solid	2 1	40	20 - 30
Berries	0.3 kg	perforated + solid	2 1	40	5 - 8
Whole fish	1 kg	perforated + solid	2 1	40 - 60	40 - 50
Fish fillet	0.4 kg	perforated + solid	2 1	40	30 - 40
Goulash	-	perforated + solid	2 1	40	85 - 95
Joint of beef	-	perforated + solid	2 1	40	90 - 100

Proving dough

Dough proves considerably more quickly in the steam oven than at room temperature.

Slide the perforated cooking container in at any shelf position. Place the dough bowl in the perforated cooking container. Do not cover the dough.

Food	Amount	Accessories	Temperature in °C	Cooking time in min.
Yeast dough	1 kg	bowl + perforated	40	20 - 30
Sourdough	1 kg	bowl + perforated	40	20 - 30

Juicing

Before juicing, place the berries in a bowl and sprinkle with sugar. Leave to stand for at least one hour to draw out the juice.

Pour the berries into the perforated cooking container and insert at level 2. Insert the solid cooking container 1 at level to catch the juice.

Finally, place the berries in a cloth and squeeze out the rest of the juice.

Food	Accessories	Level	Temperature in °C	Cooking time in min.
Raspberries	perforated + solid	2 1	100	30 - 45
Redcurrants	perforated + solid	2 1	100	40 - 50

Preserving

Preserve food which is as fresh as possible. When foods are stored for a relatively long period, their vitamin content is reduced and they cook more readily.

Clean rubber rings and jars thoroughly with hot water. The *P 18* programme ("Sterilise bottles") is also suitable for cleaning glasses.

Only use fruit and vegetables which are in perfect condition. The following foods cannot be preserved with your appliance: Contents of tins, meat, fish or pastry dough.

Place the jars in the perforated cooking container. They must not be in contact with each other.

Check preserving jars, rubber rings, clips and springs.

After the specified cooking time, open the appliance door.

Do not remove the preserving jars from the appliance until they have completely cooled down.

Food	Accessories	Level	Temperature in °C	Cooking time in min.
Vegetables	1-litre preserving jars	1	100	30 - 120
Stone fruits	1-litre preserving jars	1	100	25 - 30
Pip fruits	1-litre preserving jars	1	100	25 - 30

Frozen products

Observe the manufacturer's instructions on the packaging.

The cooking times indicated apply to dishes placed in a cold cooking compartment.

Food	Accessories	Level	Temperature in °C	Cooking time in min.
Pasta, fresh, refrigerated*	solid cooking container	2	100	5 - 10
Trout	perforated + solid cooking container	2 1	80 - 100	20 - 25
Salmon fillet	perforated + solid cooking container	2 1	80 - 100	20 - 25
Broccoli	perforated + solid cooking container	2 1	100	4 - 6
Cauliflower	perforated + solid cooking container	2 1	100	5 - 8
Beans	perforated + solid cooking container	2 1	100	4 - 6
Peas	perforated + solid cooking container	2 1	100	4 - 6
Carrots	perforated + solid cooking container	2 1	100	3 - 5

* Add a little liquid

Food	Accessories	Level	Temperature in °C	Cooking time in min.
Mixed vegetables	perforated + solid cooking container	2 1	100	4 - 8
Brussels sprouts	perforated + solid cooking container	2 1	100	5 - 10

* Add a little liquid

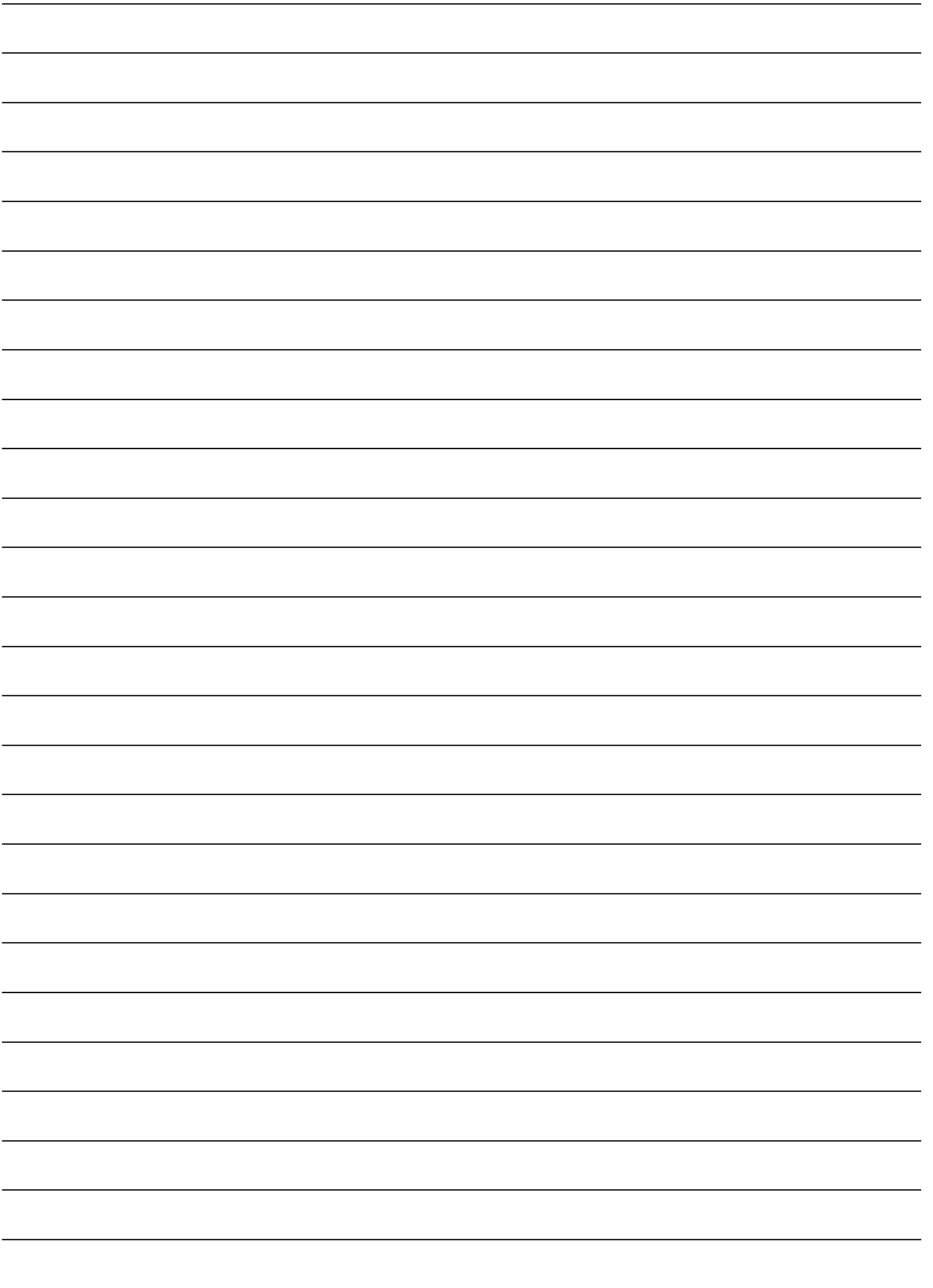



Robert Bosch Hausgeräte GmbH

Carl-Wery-Straße 34

81739 München

Germany

www.bosch-home.com



9000525882

910218