

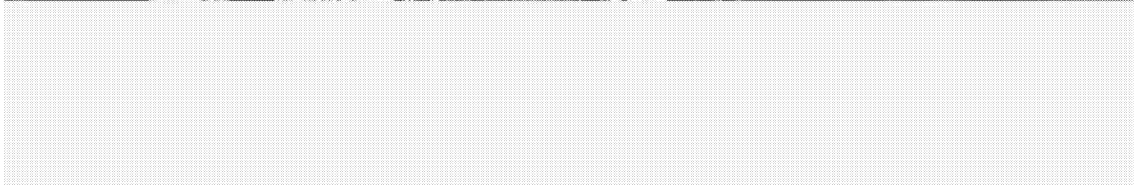

BOSCH
Invented for life



Instruction manual

HGV74W355A

This cooker is approved for use with Natural and ULPG Gas.
LEAVE INSTRUCTIONS WITH OWENER





Making cooking as much fun as eating

Please read this instruction manual. This will ensure that you make use of all the technical benefits the cooker has to offer.

It will provide you with important safety information. You will then be familiarised with the individual components of your new cooker. And we will show you how to make settings step by step. It is quite simple.

The tables list the settings and shelf positions for numerous well-known dishes. All these dishes are tested in our cooking studio.

In the unlikely event of a fault, look here for information on how to rectify minor faults yourself.

A detailed table of contents will help you to find your way around quickly.

Enjoy your meal!

Instruction manual

HGV74W355A

en

9000458503

B-060691-04

Table of contents

Important information	7
Safety precautions	7
Problems with the gas installation / smell of gas	9
Causes of damage	9
Installation and connection	11
For the installer	11
Location	12
Levelling the cooker	12
This is your new cooker	13
Cooling fan	13
The hob	14
The oven	15
Accessories	17
Before using the oven for the first time	20
Setting the clock	20
Heating up the oven	20
Cleaning the accessories	21
Cleaning the burner cups and caps before use	21
Warnings concerning cooking	22
Setting the hob	24
To ignite the burners	24
Setting the oven	25
Setting procedure	26
If the oven is to switch off automatically	27
If the oven is to switch on and off automatically	28
Rapid heating	29
Clock	30
Setting procedure	30

Table of contents

Timer	31
Setting procedure	31
Childproof lock	32
Care and cleaning	32
Cleaning agents	32
Oven back wall top and side walls	33
Cleaning and maintenance	35
For ease of cleaning	37
Detaching and attaching the oven door	37
Removing and installing the door panels	39
Detaching and refitting the rails	41
Notes	42
Troubleshooting	42
Replacing the oven light	44
Replacing the oven seal	45
Standard Symbols for hotplates	45
After-sales service	46
Notes on disposal	47
Tables and tips	48
Cakes and pastries	48
Baking tips	51
Meat, poultry, fish	52
Tips for roasting and grilling	56
Bakes, gratins, toast	56
Frozen foods	57
Special dishes	58
Defrosting	59
Drying	59



Table of contents

Tips for saving energy	60
Acrylamide in foodstuffs	61
Test dishes	62

Important information

Read this instruction manual carefully. This will enable you to operate your appliance safely and correctly.

Keep the instruction/installation manual and various accessories together in a safe place. Please pass on these manuals and accessories to the new owner if you sell the appliance.

Transport damage

Check the appliance for damage after unpacking it. Do not connect the appliance if it has been damaged in transport.

Gas connection

Only allow a licensed professional to connect the appliance. Damage caused by incorrect connection is not covered under guarantee.

Safety precautions

This appliance is intended for domestic use only. This appliance must only be used for food preparation.

Adults and children must not operate the appliance without supervision

- if they are physically, sensorially or mentally incapable of doing so
- or if they lack the knowledge and experience required to operate the appliance correctly and safely.

DO NOT SPRAY AEROSOLS IN THE VICINITY OF THIS APPLIANCE WHILE IT IS IN OPERATION.

WHERE THIS APPLIANCE IS INSTALLED IN MARINE CRAFT OR IN CARAVANS, IT SHALL NOT BE USED AS A SPACE HEATER.

DO NOT MODIFY THIS APPLIANCE.
DO NOT USE OR STORE FLAMMABLE MATERIALS IN THE APPLIANCE STORAGE DRAWER OR NEAR THE APPLIANCE.

Hot surfaces



Never touch the hotplates, the internal surfaces of the oven or the heating elements when they are hot.

There is a risk of burning.

Children must always be kept at a safe distance from the appliance.

Open the oven door carefully. Hot steam may escape.

Never place flammable objects on the hob or store them in the oven. Risk of fire

Do not trap leads of electrical appliances in the hot oven door or pull them over the hot hob. The cable insulation could melt. There is a risk of short-circuiting.

Use caution when cooking foods with high alcohol content (e.g. rum, brandy, bourbon) in the oven. Alcohol evaporates at high temperatures. There is a risk of burning as the alcohol vapors may catch fire in the oven. Use only small quantities of alcohol in foods, and open the oven door carefully.

Overheated oil and fat



Overheated oil or fat can ignite very quickly. Risk of fire.

Never leave fat or oil unattended when it is being heated.

Should the oil ignite, do not try to put it out by pouring water on it.

Cover the pan with a lid or plate immediately. Switch off the hotplate. Leave the ovenware on the hotplate to cool down.

Insufficient ventilation when cooking on gas hotplates



Do not use the gas hotplates in unventilated rooms. Cooking on gas hotplates releases extra heat and moisture.

For long cooking times, switch on the cooker hood or ventilate the area well.

Never switch on the extractor hood if the gas hotplates are not covered with pans. Risk of fire Grease deposits in the filters of the extractor hood can ignite, and the resulting hot temperatures can damage the extractor hood.

Repairs



Incorrect repairs are dangerous. There is a risk of electrocution. Repairs may only be carried out by one of our experienced after-sales engineers.

Never replace a damaged power cable yourself. Risk of electrocution The power cable may only be replaced by one of our experienced after-sales engineers.

If the appliance is faulty, remove the fuse from the fuse box. Switch off the gas supply.
Call after-sales service.

This product is not intended for use by young children or infirm persons without supervision.
Young children should be supervised to ensure that they do not play with the appliance.

Problems with the gas installation / smell of gas

If you smell gas or notice defects in the gas installation, you must:

- immediately close the gas supply or the gas bottle valve
- immediately put out any naked flames and cigarettes
- switch off electrical devices, including lights
- open the window and ventilate the room well
- call the after-sales service or your gas supplier.

Causes of damage

Damage to the hob

Only use the hotplates with ovenware on top. Do not heat up any empty pots or pans. The saucepan base will become damaged.

Do not use a roasting dish if two burners will be needed to heat the food. This will cause heat to accumulate. The appliance could be damaged.

Damage to the oven

Do not place the baking tray on the oven floor. Do not cover it with aluminium foil. Do not place dishes on the oven floor.

This will cause heat accumulation. The baking and roasting times will no longer be correct and the enamel will be damaged.

Never pour water directly into a hot oven. This will damage the enamel.

**Damage to the plinth
drawer**

When baking very moist fruit cakes, do not put too much on the baking sheet. Fruit juice dripping from the baking sheet leaves stains that cannot be removed. It is recommended that you use the deeper universal pan.

Do not stand or sit on the open oven door.

Do not place hot objects in the plinth drawer. It could become damaged.

**Damage to the front of
adjacent cabinets**

Only leave the oven to cool with the door closed. The fronts of adjacent units may be damaged over time even if you only leave the oven door open slightly.

If the oven door seal is very dirty, the door will no longer close properly during operation. The fronts of adjacent units will become damaged with time. Keep the seal clean.

Installation and connection

Gas connection

The appliance must be connected to the gas supply by a licensed expert. Extra instructions are provided with the appliance.

Electrical connection

The appliance must be connected to the mains by a licensed expert. The regulations of your electricity supplier must be observed.

Any damage arising from the appliance being connected incorrectly will invalidate the guarantee.

For the installer

The mains voltage must correspond to the voltage specified on the rating plate.

Caution.

All appliances with a three-wire cable must be earthed.

Connect the wires in the power cord according to the colour coding:

Green and yellow	earth wire (⊕)
Blue	(null) neutral wire
Brown	phase (external conductor)

If the power cord is replaced:

Only connect it to the appliance as shown in the connection diagram.

Safety precautions

An all-pole isolating switch must be present on the installation side with a contact gap of at least 3 mm. This is not necessary if the appliance is connected by a plug that is accessible to the user.

Appliances with plugs must only be connected to properly installed earthed sockets.

Electrical safety: The cooker corresponds to safety class I and may only be used in conjunction with a safety earth terminal.

A type H 05 VV-F or equal-rated lead must be used to connect the appliance.

Location

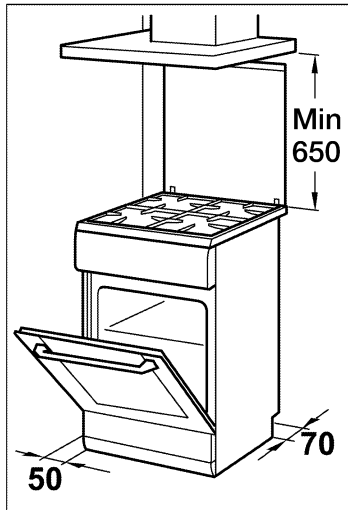

The cooker must be installed directly on the kitchen floor and in accordance with the specified dimensions.

The distance between the top edge of the cooker and the bottom edge of the extractor hood must comply with the extractor hood manufacturer's instructions.

Caution – the appliance may no longer be shifted once it is installed.

The distance from the high-speed burner or WOK burner to the front sections of adjacent furniture must be at least 50 mm.

Appliance height (in mm) 900 mm

Appliance width (in mm) 600 mm

Appliance depth (in mm) 600 mm

Levelling the cooker

Always place the cooker directly on the floor.

The cooker has height-adjustable feet. This allows you to raise the plinth by about 15 mm.

Please observe the special installation instructions.

Wall fixing

To prevent the cooker from tipping over, you must fix it to the wall at the chain. Please observe the installation instructions for fixing the oven to the wall.

This is your new cooker

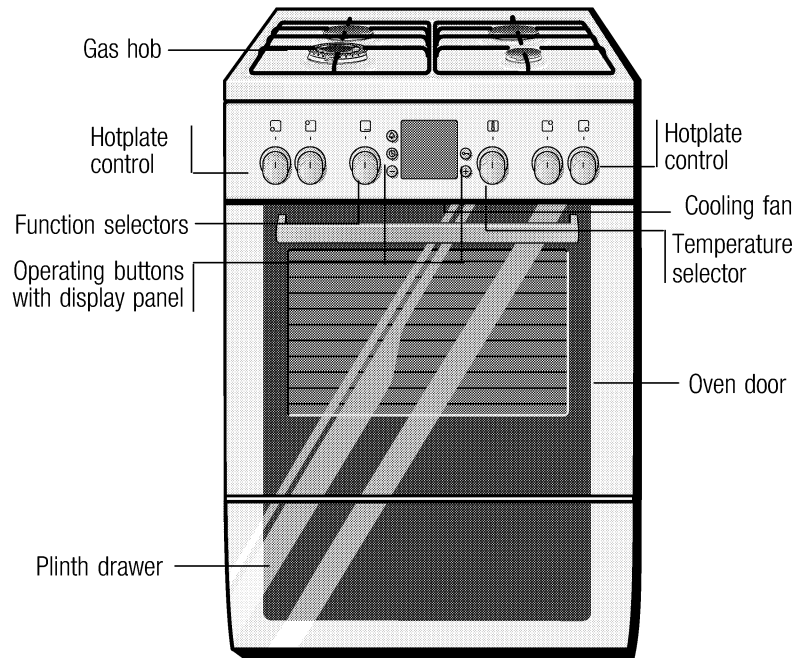

Cooling fan

The oven is fitted with a cooling fan. It switches itself on and off as necessary. The warm air escapes above the door.

The hob

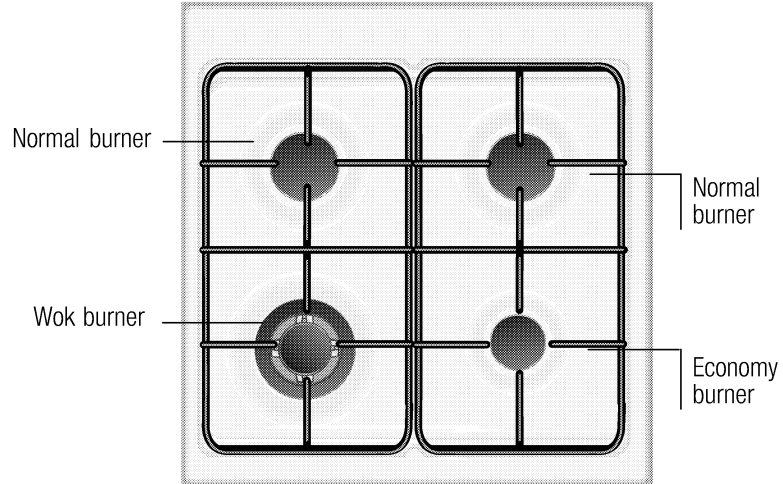

Burner	Saucepan diameter
4,0MJ/h economy burner	12-18 cm
6,5 MJ/h normal burner	18-24 cm
13,5 MJ/h wok burner	26-28 cm

Hotplate controls

You can use the four hotplate controls to control the heat output provided by each hotplate.

Setting

⏻	Off position
⚡	Ignition position
🔥	Settings range

Function/gas burners

Off
Ignition position
Large flame = highest power Economy flame = lowest power

At the end of the settings range there is a limit stop. Please do not turn the knob beyond this stop.

The oven

Use the function selector and the temperature selector to set the oven.











Function selector

Use the function selector to select the type of heating for the oven.

You can turn the function selector clockwise and anti-clockwise.

Setting

Use



 Off position	The oven switches off.
 Top/bottom heating	For cakes, bakes and lean joints of meat, e.g. beef or game, on one level. Heat is emitted evenly from the top and bottom.
 3D hot air*	For cakes and pastries on one to three levels. The fan distributes the heat from the heating ring in the back panel evenly around the cooking compartment.
 Pizza setting	For the quick preparation of frozen products without pre-heating, e.g. pizza, chips or strudel. The bottom heating element and the ring heating element in the rear wall heat up.
 Bottom heating	For preserving, browning and final baking stage. The heat is emitted from below.
 Circulated air grilling	For roasting meat, poultry and whole fish. The grill element and the fan switch on and off alternately. The fan causes the hot air to circulate around the dish.
 Grill, small area	For grilling small amounts of steaks, sausages, toast and pieces of fish. The centre part of the grill element becomes hot.
 Grill, large area	For grilling steaks, sausages, toast and pieces of fish. The whole area below the grill heating element becomes hot.
 Defrost	For defrosting, e.g. meat, poultry, bread and cakes. The fan causes the warm air to circulate around the dish.
 Rapid heating	For rapid preheating of the oven without accessories.

* The type of heating with which the energy efficiency class was determined in accordance with EN50304.

The light comes on in the cooking compartment when you make the setting.

Temperature selector





The temperature selector is used to set the temperature or grill setting.

Setting		Meaning
!	Off position	The oven does not heat up.
50-300	Temperature range	The temperature in the cooking compartment in °C.
1, 2, 3	Grill setting	The grill settings for the  small and  large area grill. Level 1 = low Level 2 = medium Level 3 = high

When the oven is heating, the ! temperature symbol lights up in the display. It goes out during pauses in the heating. The symbol does not light up for grilling and defrosting.

Buttons and display

You can use the buttons to set various additional functions. You can read the values that you have set in the display.

Button	Use
 Timer button	This is used to set the timer.
 Clock button	This is used to set the Clock,  Oven duration and  End time.
- Minus button	Use this button to decrease the setting values.
 Key button	This is used to switch the childproof lock on and off.
+ Plus button	Use this button to increase the setting values.

Accessories

The accessories can be inserted into the oven at 5 different levels.

The pull-out rails at levels 2 and 3 allow you to pull the accessories out further without them tipping.

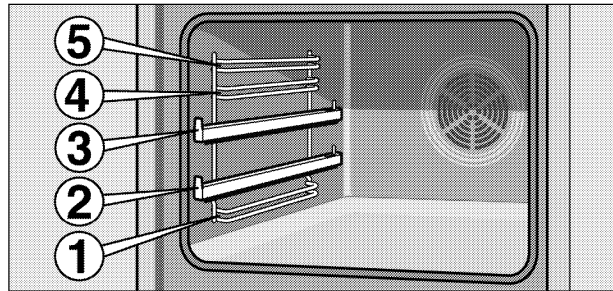

The accessories can become deformed when they become hot. As soon as they have cooled down, the deformation disappears with no effect on the function.

You can buy accessories from the after-sales service, from specialist retailers or online. Please specify the HEZ number.



Wire shelf

For ovenware, cake tins, roasts, grilling and frozen meals.

Insert the wire grill with the curved bars facing downwards .

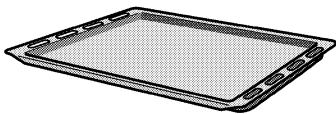

Enamel baking tray

For cakes and biscuits.

Push the baking tray into the oven with the sloping edge facing towards the oven door.

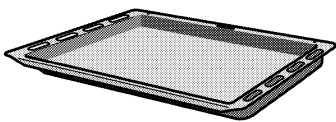

Universal pan

For moist cakes, pastries, frozen meals and large roasts. It can also be used to catch dripping fat when you are grilling directly on the wire rack.

Slide the universal pan into the oven with the tapered edge facing the oven door.

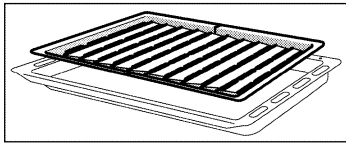

Grill pan

Can be used for grilling instead of the wire grill or as a spray guard to protect the oven against dirt. Only use the grill pan in the universal pan.

To grill using the grill pan: use the same shelf height as for the wire grill.

Using the grill pan as a spray guard: insert the universal pan with the grill pan under the wire grill.

Special accessories

You can purchase special accessories from the after-sales service or specialist shops.

You will find a comprehensive range of products for your oven in our brochures and on the Internet.

The availability of special accessories and whether it is possible to order them online may vary depending on your country. Please see the sales brochures for more details.

Wire shelf HEZ 334000	For ovenware, cake tins, roasts, grilling and frozen meals.
Enamel baking tray HEZ 331000	For cakes and biscuits.
Universal pan HEZ 332000	For moist cakes, pastries, frozen meals and large roasts. It can also be used to catch dripping fat when you are grilling directly on the wire rack.
Insert shelf HEZ 324000	For roasting. Always place the shelf in the universal pan. This ensures that dripping fat and meat juices are collected.
Grill tray HEZ 325000	Use for grilling in place of the wire shelf or as a splatter guard, so that the oven does not become very dirty. Only use the grill tray in the universal pan. Grilling on the grill tray: Only use in the shelf positions 1, 2 and 3. The grill tray as a splash guard: Insert the universal pan with the grill tray under the wire shelf.
Glass pan HEZ 336000	A deep baking tray made of glass. Can also be used as a serving dish.
Enamel baking tray with non-stick coating HEZ 331010	Cakes and biscuits can be removed more easily from the baking tray. Push the baking tray into the oven with the sloping edge facing towards the oven door.

Universal pan with non-stick coating HEZ 332010	Cakes and biscuits can be removed more easily from the baking tray. Push the baking tray into the oven with the sloping edge facing towards the oven door.
Pizza tray HEZ 317000	Ideal for pizza, frozen foods or large round cakes. You can use the pizza tray instead of the universal pan. Place the baking tray on the grid and proceed according to the details in the tables.
Bakestone HEZ 327000	The bakestone is wonderful for preparing home-made bread, bread rolls and pizzas which need to have a crispy base. The bakestone must always be preheated to the recommended temperature.
Profi extra-deep pan with insert grid HEZ 333000	Particularly suitable for preparing large quantities of food.
Lid for the Profi extra-deep pan HEZ 333001	The lid converts the Profi extra-deep pan into the Profi roasting dish.
Glass roasting dish HEZ 915001	The glass roasting dish is suitable for pot roasts and casseroles that are cooked in the oven. It is ideally suited to automatic roasting.
Metal roasting dish HEZ 6000	The roasting dish is intended for use on the extended cooking zone of the ceramic hob. It is suitable for the sensor cooking system as well as for the automatic roasting function. The roasting dish is enamel on the outside with a non-stick coating on the inside.
Universal roasting dish HEZ 390800	For particularly large or numerous portions. The roasting dish has a granite enamel exterior and an ovenproof glass lid. The glass lid can be used as a gratin dish.
After-sales service products	You can obtain suitable care and cleaning agents and other accessories for your domestic appliances from the after-sales service, specialist retailers or (in some countries) online via the e-Shop. Please specify the relevant product number.
Door lock product no. 469088	To prevent children from opening the oven door. Depending on the design of the appliance door, the lock will be screwed on differently. Observe the information on the supplement sheet that comes with the door lock.

Before using the oven for the first time

In this section, you can find out what you must do before using your oven to prepare food for the first time.

First read the section on *Safety information*.

Setting the clock

After the oven has been connected, the ⏸ symbol and three zeros light up on the display. Set the clock.

1. Press the ⏸ button.
12:00 appears in the display and the ⏸ symbol flashes.
2. Use the + or – button to change the clock.

After a few seconds, the time that has been set is adopted.

Heating up the oven

To remove the new cooker smell, heat up the oven when it is empty and closed. An hour of  Top/bottom heating at 240 °C is ideal.

Ensure that no packaging has been left in the cooking compartment.

1. Use the function selector to set  Top/bottom heating.
2. Use the temperature selector to set the temperature to 240 °C.

After an hour, switch off the oven. Turn the function selector and temperature selector to the off position.

Cleaning the accessories

Before you use the accessories for the first time, clean them thoroughly with hot soapy water and a soft dish cloth.

Cleaning the burner cups and caps before use

Clean burner cups (B) and caps (A) with water and detergent. Dry the parts thoroughly. Place the relevant burner cup (B) on the hotplate (C). Ensure the burner cap (A) is fitted exactly to the top of the cup.

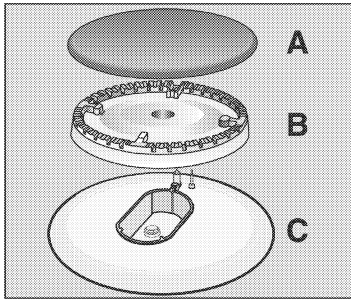

Warnings concerning cooking

DON'Ts

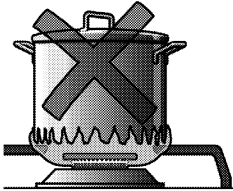

Do not use small receptacles on large burners. The flame should not touch the sides of receptacles.

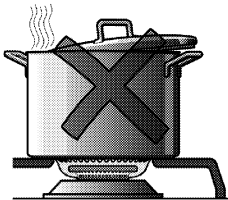

Do not cook without lids or with lids only partially covering receptacles. You are wasting energy.

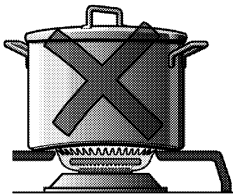

Do not use receptacles with uneven bases. They lengthen cooking times and increase energy consumption.

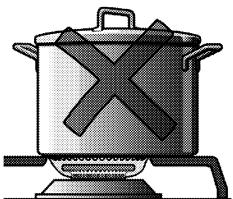

Do not place receptacles on burners off centre. They could tip over.

DOs

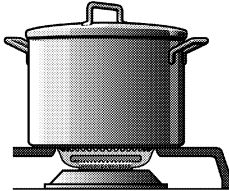

Always use suitably sized receptacles on each burner. This helps avoid excessive gas consumption and prevents receptacles from getting tarnished.

Always use **lids**.

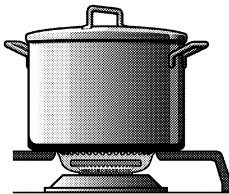

Only use thick-, flat-based saucepans, **frying pans and casseroles**.

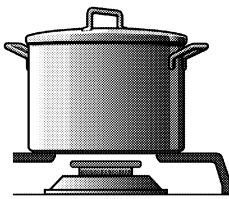

Always place receptacles **in the middle** of burners

DON'TS

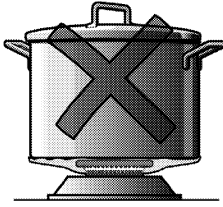

Do not place receptacles directly on top of burners.

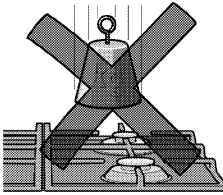

Do not use excessive weights or strike the hob with heavy objects.

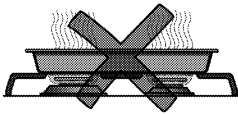

Do not use two burners or heat sources for a single recipient.

Do not use baking trays, earthenware dishes, etc. at full heat for a long time.

DOs

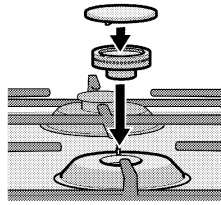

Always place receptacle **on the pan support**. Make sure that the metal grids and the tops of the burners are correctly positioned before using them.

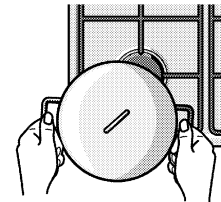

Handle receptacles on the hob with **care**.

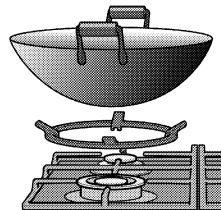

Only use one recipient per burner. Use the extra metal grid on the burner with three flames.

Setting the hob

The hob is equipped with 4 gas burners. Here you can find out how to ignite the gas burners.

To ignite the burners

Always make sure that the burner cap is fitted properly on the burner cup. The slots of the burner cup must not be obstructed. All burner parts must be dry.

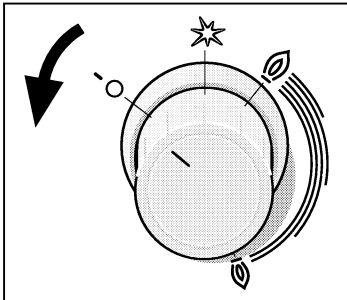

1. If the hob has a lid, open it. It must remain open during all operation of the appliance.
2. Turn the control dial for the desired burner anti-clockwise to the  ignition position. Ignition begins.

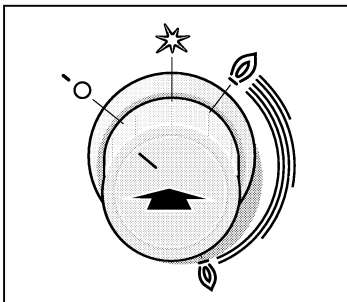

3. Push the control dial in fully and **hold for** 1-3 seconds. The gas that flows is ignited by the ignition spark.

This activates the safety function, which automatically cuts the gas supply to the burner concerned if the flame goes out.

The ignition function must not be operated for longer than 15 seconds. If the burner has not lit after 15 seconds, you should stop operating the ignition function. Wait at least one minute before trying to light the burner again.

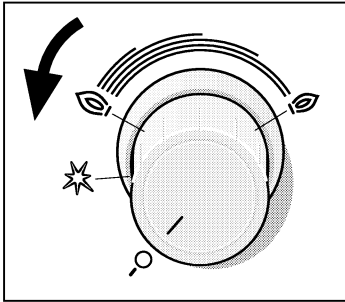

Switching off

4. Set the desired flame height. The flame is not stable between the ● OFF and 🔒 settings. For this reason, you should select a setting between the 🔒 maximum and 🔒 minimum flame settings.
5. Check that the flame is lit. Otherwise repeat the process from step 2.

6. Turn the control dial ● clockwise to the OFF position.



If you operate the control dial for a burner that is still warm shortly after you have switched it off, gas will flow out. If the control dial is not moved to the ✨ ignition position within 60 seconds, the safety function will be activated and the gas supply will be cut off.

The gas burner does not light

If there is a power cut, or if the ignitors are damp, you can light the gas burners with a piezo gas lighter or a match.

Setting the oven

You have various options for setting the oven.

Switching off the oven manually

When your meal is ready, switch off the oven yourself.

The oven switches off automatically

You can leave the kitchen for a long period.

The oven switches on and off automatically

You can put your meal in the oven in the morning, for example, and set the oven so that your meal is ready at midday.

Tables and tips

The correct settings for many dishes can be found in the Tables and tips section.

Setting procedure

Example:
Top/bottom heating ,
200 °C

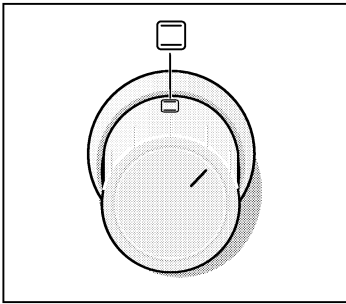

1. Select the desired type of heating using the function selector.

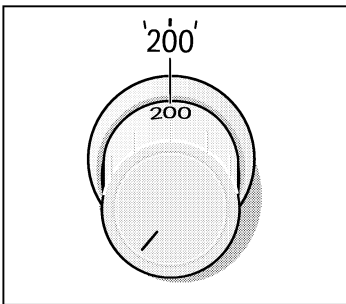

2. Use the temperature selector to set the temperature or grill setting.

Switching off

Switch off the function selector when the meal is ready.



Changing the setting

You may change the temperature or grill setting at any time.

If the oven is to switch off automatically

Make the settings as described in steps 1 and 2.
Now enter the duration (cooking time) for your meal.

Example in picture: setting for  Top/bottom heating, 200 °C, cooking time 45 minutes.

3. Press the  Clock button.
The  Cooking time symbol flashes.

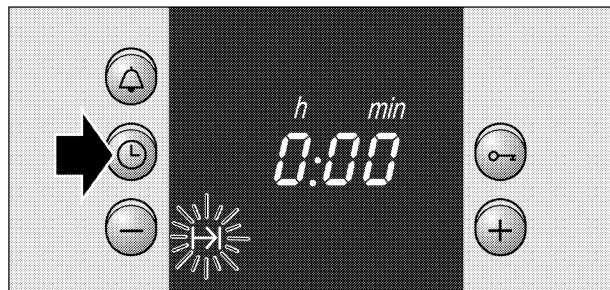

4. Use the – minus or + plus button to change the cooking time.
+ button default value = 30 minutes
– button default value = 10 minutes



The cooking time has elapsed

A signal sounds. The oven switches off.
Press the  button twice and turn off the function selector.

Changing the setting

Press the  Clock button. Use the + or – button to change the cooking time.

Cancelling the setting

Press the ⏸ Clock button. Press the – button until zero is shown on the display. Switch off the function selector.

Setting the cooking time if the clock is hidden

Press the ⏸ Clock button twice and set as described in point 4 above.

If the oven is to switch on and off automatically

Please remember that easily spoiled foods must not be allowed to remain in the cooking compartment for too long.

Make the settings as described in steps 1 to 4.

Example in picture: setting for  Top/bottom heating, 200 °C. It is 10:45. The meal takes 45 minutes to cook and should be ready at 12:45.

5. Press the ⏸ Clock button repeatedly until the → End symbol flashes.
You can see in the display when the meal will be ready.

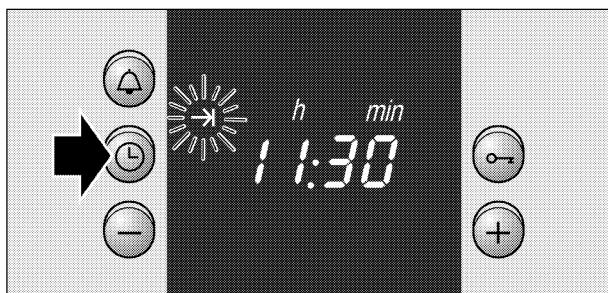

6. Use the + button to set a later end time.
The setting is adopted after a few seconds.
The end time is shown in the display until the oven starts.



The cooking time has elapsed

A signal sounds. The oven switches off. Press the  button twice and turn off the function selector.

Note

You can make changes as long as the symbol is flashing. The setting has been adopted if the symbol is lit. You can change the waiting time needed for the setting to be adopted. For more information, refer to the section Basic settings.

Rapid heating

With rapid heating, your oven reaches the temperature selected particularly quickly.

Use rapid heating when temperatures above 100 °C are selected.

To ensure an even cooking result, do not place your dish in the cooking compartment until rapid heating is complete.

1. Set the function selector to .
2. Turn the temperature selector to set the desired temperature.

The  symbol lights up in the display. The oven begins to heat up.

The rapid heating process is complete

The  symbol goes out in the display. Place your dish in the oven and select the desired type of heating.

Clock

When the appliance is connected for the first time or after a power cut, the ⌚ symbol and three zeros flash in the display. Set the clock.

The function selector must be switched off.

Setting procedure

Example: 13:00

1. Press the ⌚ button.
12:00 appears in the display and the ⌚ symbol flashes.
2. Use the + or – button to change the clock.
After a few seconds, the time is saved.
The ⌚ symbol goes out.

Changing from summer to winter time, or similar

Press the ⌚ Clock button twice and change using the + or – buttons.

Hiding the clock

You can hide the clock. This means it is only visible when you choose this setting.



To do this, you must change the basic settings. For more information, refer to the section Basic settings.

Timer

You can use the timer as a kitchen timer. It runs independently of the oven.
The timer has a special signal. This means that you can tell whether the timer duration or the cooking time has elapsed.
You can also set the timer if the childproof lock is active.

Setting procedure

Example: 20 minutes

1. Press the  Timer button.
The  symbol flashes.
2. Use the – minus or + plus button to change the timer duration.
+ button default value = 10 minutes
– button default value = 5 minutes
The timer starts after a few seconds. The  symbol lights up in the display. You will see the time counting down.

When the time has elapsed

A signal sounds.
Press the  Timer button. The timer goes out.





Changing the timer duration

Press the  Timer button. Use the + or – button to change the time.

Cancelling the setting

Press the  Timer button. Press the – button until zero is shown on the display.



The timer and cooking time count down at the same time

Both symbols light up. The timer duration starts counting down in the display.
To call up the remaining  Duration,  End time or  Clock: Press the  Clock button repeatedly until the relevant symbol appears.
The value you are checking appears for several seconds on the display.

Childproof lock

The oven has a childproof lock to prevent children from switching it on accidentally.

Locking the oven

Press the  key button until the  symbol appears in the display. This will take approximately 4 seconds.

Unlocking

Press the  key button until the  goes out.

Notes

You can set the timer and the clock even when the oven is locked.

The childproof lock setting will be lost if there is a power cut.

Care and cleaning

Clean the appliance on a regular basis and remove any food deposits. The surface of the appliance could be damaged and the appliance could corrode over time if it is not cleaned with sufficient care.



Do not use high-pressure cleaners or steam jets.



Do not use caustic or abrasive cleaning agents.

Cleaning agents

Appliance exterior

Use soapy water and dry with a soft cloth.

Gas hob and pan supports

Hot soapy water. Use very little water, water must not be allowed to enter the appliance through the burner bases. Clean boiled over fluids and spilt food immediately. You can remove the pan support.



Do not clean the pan support in the dishwasher.

Gas burners	Remove the burner cups and caps, clean them with soapy water. The gas outlet openings must remain free. Spark ignitions: small, soft brush. The gas burners only function when the spark ignitions are clean. Dry all parts thoroughly. Ensure they fit exactly when replaced. The burner caps are coated in black enamel. The colour may change over time. This does not affect their function.
Hob cover	Glass cleaner. You can remove the hob cover.
Oven floor	Hot soapy water or a vinegar solution. For heavy soiling: only use oven cleaner in a cold oven. Do not use on the rear wall, top and side walls.
Glass cover on the oven light	Hot soapy water.
Seal	Hot soapy water.
Rails	Hot soapy water.
Door panel	Glass cleaner, the glass scraper should not be used for this purpose.
Plinth drawer	Hot soapy water.
Accessories	Soak in hot soapy water. Clean with a brush or sponge.

Oven back wall top and side walls

The back wall, top and side walls in the oven clean themselves. They are coated with a highly porous ceramic layer. This coating absorbs and dispels splashes from baking and roasting while the oven is in operation. You will obtain a better result, the higher the temperature and the longer the oven is in operation.

If splashes are still visible even after repeated use, proceed as follows:

First clean the enamel surfaces in the oven. Then select 3D hot air  or top and bottom heating . Heat up the empty oven for approximately 2 hours at maximum temperature.

The ceramic coating is regenerated. Brownish or whitish residues can be removed with water and a soft sponge.

Light discolouration of the coating does not affect automatic self-cleaning.



Important notes

If the self-cleaning surfaces of the oven are no longer cleaning themselves sufficiently, they can be regenerated using the cleaning function.

Never use abrasive detergent. You will scratch or destroy the highly porous coating.

Never clean the back wall, top and side walls with oven cleaner.

If oven cleaner accidentally gets onto the back wall or side walls, remove it immediately with a sponge and plenty of water.

Cleaning and maintenance

DON'Ts

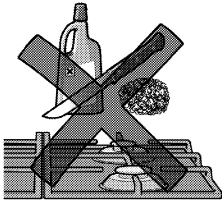

Do not use scouring powder, over cleaner sprays or abrasive pads that may scratch the glass. Never use sharp objects such as knives or wire wool to remove the remains of food that has become encrusted onto the surface.

Do not use knives, scrapers or similar implements for cleaning the joints between the glass and the rims of the burners or the metal surrounds.

Do not slide recipients over the glass as they may scratch it.

DOs

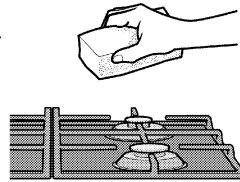

Once the appliance is cold, clean it with a **sponge and soapy water.**

Clean the surface of the heating elements once they have cooled down, each time they are used. Even small amounts of dirt burn when it is switched on again.

DON'Ts

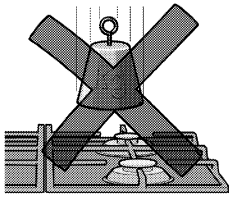

Similarly, do not drop hard or sharp objects onto the glass. Avoid knocking any part of the edge of the cooking plate.

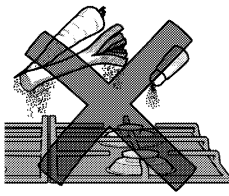

Grains of sand, which may, for example, come from cleaning vegetables, can scratch the glass surface.

DOs

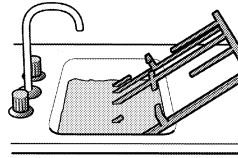

The burners and pan support must be cleaned regularly to keep them clean.

This is done by submerging them in soapy water and scrubbing them with a non-metal brush to keep the holes and slits free from obstruction so they can give a perfect flame. Dry the burner covers whenever wet or damp.

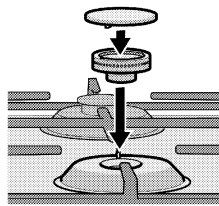

After cleaning and drying the burners, make sure that the covers are properly in position on the flame diffuser.

The high temperatures suffered by the cover on the triple-flame burner ring and the stainless steel parts on your hob (plate rings, grease trays, area around burners, etc) may become discoloured over time. This is **normal**. Clean them after use with a product suitable for stainless steel.

After washing the pan support, dry them thoroughly before cooking with them again. The presence of droplets of water or dampness at the beginning of the cooking process may damage the enamel surface.

Be careful with the feet on the metal grids when cleaning them; if they are detached, the grid may scratch the glass next time it is used.

For ease of cleaning

Switching on the oven light

For ease of cleaning, you can switch on the oven light and detach the oven door.

Set the function selector to .

Detaching and attaching the oven door

For cleaning purposes and to remove the door panels, you can detach the oven door.

The oven door hinges each have a locking lever. When the locking levers are closed (Fig. A), the oven door is secured in place. It cannot be detached. When the locking levers are open in order to detach the oven door (Fig. B), the hinges are locked. They cannot snap shut.

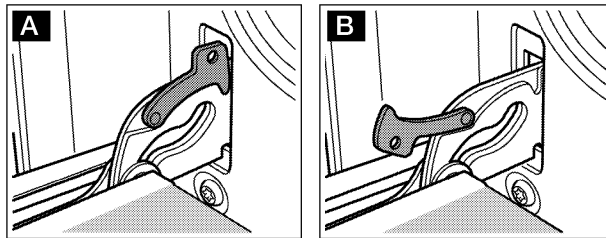

 There is a risk of injury. Whenever the hinges are not locked, they snap shut with great force. Ensure that the locking levers are always fully closed or, when detaching the oven door, fully open.

Detaching the door

1. Open the oven door fully.
2. Open the locking levers on the left and right-hand sides (Fig. A).
3. Close the oven door up to the limit stop (Fig. B). Grip the door on the left and right-hand sides with both hands. Close the door a little more and pull it out.

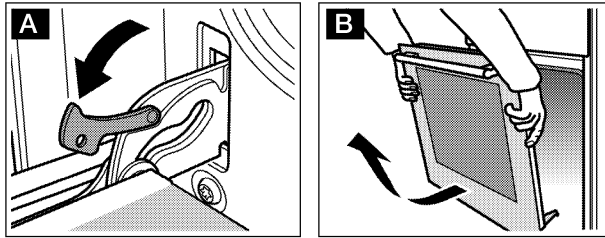

Attaching the door

Reattach the oven door in the reverse sequence to removal.

1. When attaching the oven door, ensure that both hinges are inserted straight into the opening (Fig. A).
2. The notch on the hinge must engage on both sides (Fig. B).

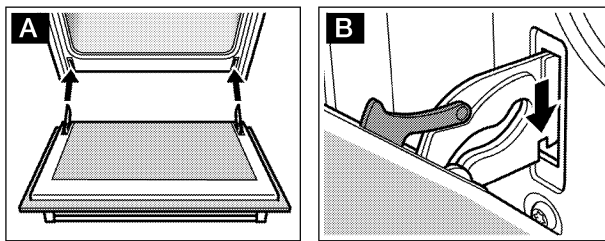

3. Close both locking levers again (Fig. C).
Close the oven door.

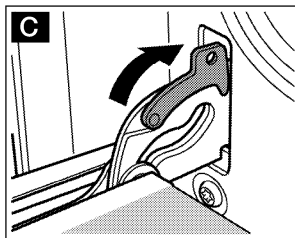

There is a risk of injury. If the oven door falls out accidentally or a hinge snaps shut, do not reach into the hinge.
Call the after-sales service.

Removing and installing the door panels

Removal

To facilitate cleaning, you can remove the glass panels from the oven door.

When removing the inner panels, pay attention to the order in which the panels are removed.

1. Detach the oven door and lay on a cloth with the handle facing down.
2. Unscrew the cover on top of the oven door. To do this, undo the right and left-hand screws (Fig. A)
3. Lift the uppermost panel and pull out. (Fig. B)

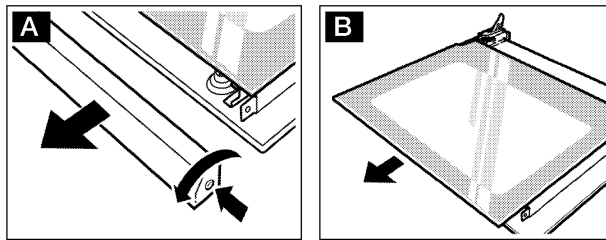

4. Unscrew the large clips on the right and left and remove them. (Fig. C)
Remove the centre panel.
5. Remove the small clips from the lower panel. (Fig. C)
Pull out the panel diagonally upwards.

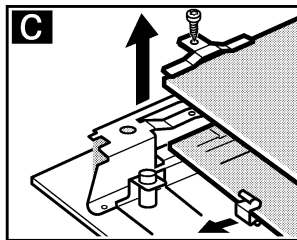

Clean the panels with glass cleaner and a soft cloth.

Do not use sharp or abrasive materials or a glass scraper. The glass could be damaged.

Installation

1. Insert the bottom panel diagonally towards the back. (Fig. A)
2. Place the small clips on the right and left side of the bottom panel.
3. Insert the centre panel. (Fig. B)

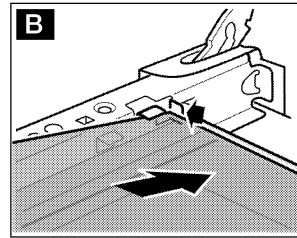
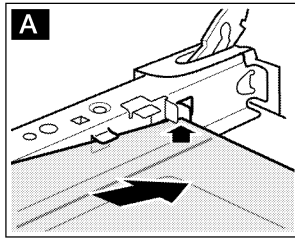

4. Fit the small clips to the lower panel. (Fig. C)
5. Attach the large clips on the right and left and screw tight. (Fig. C)

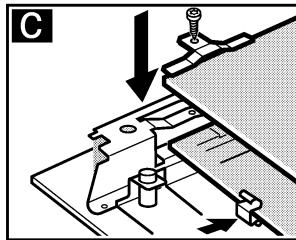

6. Insert the uppermost panel diagonally towards the back. The smooth surface must face outwards.
7. Replace the cover and screw in place.
8. Attach the oven door.

Do not use the oven again until the panels have been correctly fitted.

Detaching and refitting the rails

Detaching the rails

The rails can be removed for cleaning. The oven must have cooled down.

1. Lift the front of the rails upwards
2. and detach (Fig. A).
3. Then pull the rails forward and take them out (Fig. B).

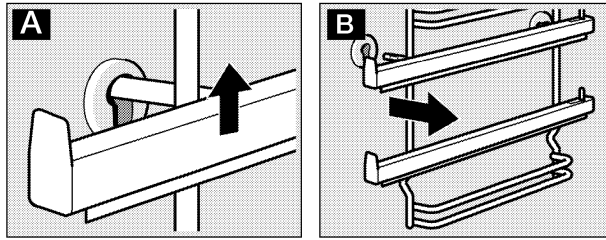

Clean the rails with cleaning agent and a sponge. For stubborn deposits of dirt, use a brush.

Refitting the rails

1. First insert the rails into the rear socket and push them back slightly (Fig. A)
2. and then hook them into the front socket (Fig. A).

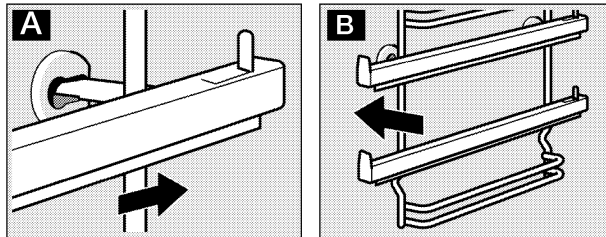

The rails fit only on the right or the left side. The kinked section must always be at the bottom.

Notes

Enamel in the oven is baked on at very high temperatures. This can cause some slight colour variation. This is normal and does not affect the function. Do not use coarse scouring pads or strong cleaning agents to remove such discolourations.

The edges of thin trays cannot be completely enamelled. As a result, these edges can be rough. Anti-corrosion protection is guaranteed.

Troubleshooting

Should a malfunction occur, it is often only due to a minor fault. Please read the following instructions before calling the after-sales service.

Important:

Only authorised personnel from the Service Centre are qualified to work on the main gas and electric systems.

Problem	Possible cause	Comments/remedy
The oven does not work.	Blown fuse.	Look in the fuse box and check that the fuse is in working order.
The clock display flashes.	Power cut	Reset the time.
...If none of the electrical systems work.	Power turned off	Turn power on.
	Faulty fuse	Check the fuse in the main fuse box and replace if faulty.
	The automatic circuit breaker or mains differential has been triggered.	Check to see if the circuit breaker or a differential has been triggered in the mains.

Problem	Possible cause	Comments/remedy
...If the electronic ignition system does not work.	There may be food or cleaning product particles between the spark plugs and the burners.	The gap between the spark plug and the burner needs to be cleaned carefully.
...If the flame on the burners is not evenly distributed.	The burner components have not been assembled properly.	Put the components in their right position.
	The gas ports on the burner are dirty.	Clean the gas ports on the burner.
...If the gas flow does not seem normal or there is no gas flow.	The isolation valve is closed.	Open the isolation valve.
	If the gas is supplied from a gas bottle, it may be empty.	Replace the gas bottle with a new gas bottle.
...If the kitchen smells of gas.	One of the valves has been left open.	Check to see if a valve has open.
	Possible leak on the gas bottle.	Check that the coupling on the gas bottle is in order.
...If the safety cut-off devices on the different burners do not work.	The control knob has not been kept pressed in for long enough.	Once ignited, keep the control pressed in for a few seconds.
	The burner ports are dirty.	Clean the burner ports.

Repairs may only be carried out by fully trained after-sales service technicians.

Improper repairs may constitute serious hazards to the user.

Any of the following are considered to be abnormal operation and may require servicing:

- Yellow tipping of the hob burner flame.
- Sooting up of cooking utensils.
- Burners not lighting properly.
- Burners failing to remain alight.

Gas valves, which are difficult to turn in case the appliance fails to operate correctly, contact the authorised service provider in your area.

Replacing the oven light

Method

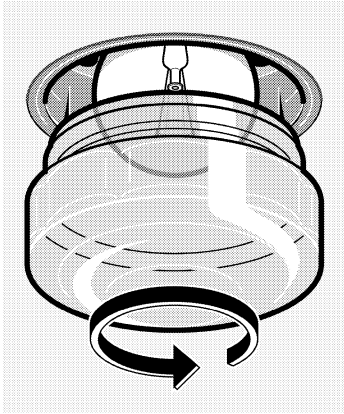

Replacing the glass cover

If the oven light fails, it must be replaced. 40 watt heat-resistant spare bulbs can be obtained from the after-sales service or specialist shops. Only use these bulbs.

1. Switch off the oven fuse in the fuse box.
2. Place a tea towel in the cold oven to prevent damage.
3. Unscrew the glass cover by turning it anti-clockwise.
4. Replace the oven light with one of the same type.
5. Screw the glass cover back on.
6. Remove the tea towel and switch the fuse back on.

You must replace a damaged glass cover. The replacement glass cover may be obtained from the after-sales service. Please specify the E number and FD number of your appliance.

Replacing the oven seal

If the oven seal is faulty, it must be replaced by an after-sales service expert. A faulty oven seal can result in high energy losses. The fronts of adjacent units could be damaged.

Standard Symbols for hotplates

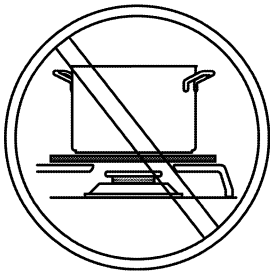

Do not place anything, eg. flame tamer, asbestos mat, between pan and pan support as serious damage to the appliance may result.

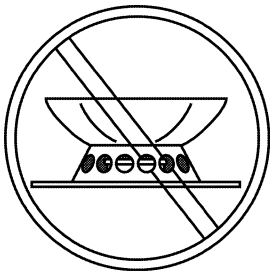

Do not remove the pan support and enclose the burner with a wok stand as this will concentrate and deflect heat onto the hotplate.

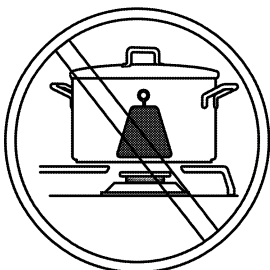

Do not use large pots or heavy weights which can bend the pan support or deflect flame onto the hotplate.

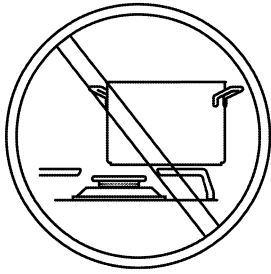

Locate pan centrally over the burner so that it is stable and does not overhang the appliance.

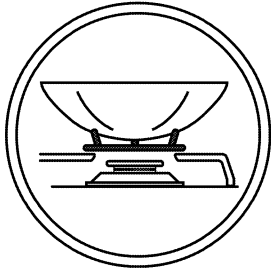

Use only a wok support supplied or recommended by the manufacturer of the appliance.

After-sales service

Our after-sales service is there for you if your oven needs repairing. You will find the address and telephone number of your nearest after-sales service centre in the phone book. The after-sales service centres listed will also be happy to advise you of a service point in your local area.

E number and FD number

Please quote the E number (product number) and the FD number (production number) of your appliance when contacting the after-sales service. The rating plate containing these numbers is found on the right, on the side of the oven door. You can make a note of these numbers in the space below to save time in the event of your appliance malfunctioning.

E no.	FD no.
-------	--------

After-sales service ☎

Notes on disposal

Your new appliance was protected by suitable packaging while it was on its way to you. All materials used for this purpose are environment-friendly and suitable for recycling. Please make a contribution to protecting the environment by disposing of the packaging appropriately.

Old appliances are not worthless rubbish! Environment-conscious recycling can reclaim valuable raw materials.

Before disposing of your old appliance, please make sure that it is unusable, or label it with a sticker stating "Caution: This appliance is defective!"

Up-to-date information concerning options for disposing of your old appliance and the packaging from the new one can be obtained from your retailer or local municipal office.

Tables and tips

This table contains a selection of dishes and the optimum settings at which to cook them. You can find out which type of heating and temperature is best for your dish, which accessories to use, and at which oven level the dish should be inserted. You will find a variety of tips about ovenware and preparation, and a small troubleshooting section in case anything should go wrong.

Cakes and pastries

Baking on one level

If you are baking cakes on one level, you should use top/bottom heating . This will give the best results for your cakes.

Baking tins

It is best to use dark-coloured baking tins made of metal. Baking times are increased when light-coloured baking tins made of thin metal or glass dishes are used, and cakes do not brown so evenly.

Always place the cake tin on the wire grill.

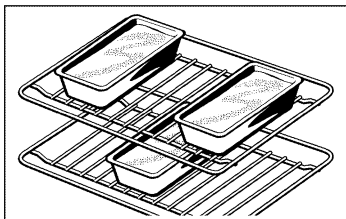

If you are cooking using three tins at the same time, position these as illustrated.

Tables











The values in the table apply to dishes placed in a cold oven. This saves energy. Shorten the baking times indicated by 5 to 10 minutes if you have preheated the oven.

The tables show which type of heating is best for different cakes and bakes.

The temperature and cooking time you select depends on the quantity and type of pastry. This is why “ranges” are given in the tables. You should try to use a lower







temperature setting to start with, since this allows more even browning. If necessary, use a higher temperature setting the next time.





More information can be found in the “Baking tips” section which follows the tables.

Cakes in tins	Tin on the wire rack	Level	Type of heating	Temperature in °C	Baking time in minutes
Sponge, simple	Round/Ring/cake tin	2		170-190	50-60
	3 cake tins*	1+3		150-170	70-100
Sponge, delicate (e.g. pound cake)	Round/Ring/cake tin	2		150-170	60-70
	3 cake tins*	1+3		140-160	70-100
Short pastry base with edge	Springform cake tin	1		170-190	25-35
Sponge flan case	Fruit flan tin	2		150-170	20-30
Sponge cake	Springform cake tin	2		160-180	30-40
Fruit flan or cheesecake, short crust pastry**	Non-stick springform cake tin	1		170-190	70-90
Fine sponge fruit flan	Springform cake tin/bowl mould	2		160-180	50-60
Spiced cake** (e.g. quiche/onion tart)	Springform cake tin	1		180-200	50-60

* Position the cake tins correctly.



** Allow cakes to cool in the oven for approximately 20 minutes.

Cakes on the tray		Level	Type of heating	Temperature in °C	Baking time in minutes
Sponge or yeast pastry with dry topping	Baking tray	2		170-190	20-30
	Baking tray + universal pan**	1+3		150-170	35-45
Sponge or yeast pastry with fruit topping*	Baking tray	3		170-190	40-50
	Baking tray + universal pan**	1+3		150-170	50-60
Swiss roll (preheat)	Baking tray	2		190-210	15-20
Plaited loaf made with 500 g flour	Baking tray	2		160-180	30-40









Cakes on the tray		Level	Type of heating	Temperature in °C	Baking time in minutes
Stollen made with 500 g flour	Universal pan	3		160-180	60-70
Stollen made with 1 kg flour	Universal pan	3		150-170	90-100
Strudel, sweet	Universal pan	2		180-200	55-65
Pizza	Baking tray	2		220-240	25-35
	Baking tray + universal pan**	1+3		180-200	40-50



* Use the deeper universal pan for very moist fruit cakes.

** Always place the universal pan above the tray when you are cooking on two levels at once.

Bread and rolls		Level	Type of heating	Temperature in °C	Cooking time in minutes
Bread made from 1.2 kg flour* (preheat)	Universal pan	2		300	8
				200	+35-45
Sour dough bread made from 1.2 kg flour* (preheat)	Universal pan	2		300	8
				200	+40-50
Bread rolls (e.g. rye rolls)	Universal pan	4		200-220	20-30

* Never pour water directly into a hot oven.

Small baked products		Level	Type of heating	Temperature in °C	Baking time in minutes
Biscuits	Baking tray	3		150-170	10-20
	Baking tray + universal pan**	1+3		130-150	25-35
	2 baking trays* + universal pan***	1+3+5		130-150	30-40
Meringue	tray	3		80-100	100-190
Cream puffs	tray	2		200-220	30-40
Macaroons	Baking tray	3		100-120	30-40
	Baking tray + universal pan**	1+3		100-120	35-45
	2 baking trays* + universal pan***	1+3+5		100-120	40-50

Small baked products		Level	Type of heating	Temperature in °C	Baking time in minutes
Puff pastry	Baking tray	3		190-210	20-30
	Baking tray + universal pan**	1+3		190-210	30-40
	2 baking trays* + universal pan***	1+3+5		190-210	35-45

* Additional baking trays may be obtained as optional accessories from specialist shops.

** Always place the universal pan above the tray when you are cooking on two levels at once.

*** Insert the universal pan at the bottom of the oven. This can be removed before cooking.

Baking tips

You wish to cook to your own recipe.	Refer to the instructions in the tables for similar types of food.
How to check that a sponge cake is cooked properly.	Approximately 10 minutes before the end of the baking time given in the recipe, pierce the tallest point of the cake with a cocktail stick. The cake is done if the cocktail stick comes out clean.
The cake collapses.	Next time, use less liquid or decrease the oven temperature by 10 degrees. Observe the cooking times in the recipe.
The cake has risen in the centre but is lower at the edges.	Do not grease the sides of the springform cake tin. As soon as the cake is done, carefully loosen the cake around the edges using a knife.
The cake is too dark at the top.	Insert it at a lower level in the oven, select a lower temperature and cook the cake a little while longer.
The cake is too dry.	Use a toothpick to make small holes in the finished cake. Then drizzle fruit juice or alcohol over the top. Next time you should decrease the temperature by around 10 degrees and reduce the baking times.
The bread or cake (e.g. cheesecake) looks fine, but is soggy on the inside (soft, with watery areas).	Next time you should add a little less liquid and cook for a little longer at a lower temperature. Cakes with fruit topping: Precook the base first of all. Sprinkle with almonds or breadcrumbs and then place the topping over this. Please observe the recipe and the baking times.

The pastries are not evenly browned.

Select a slightly lower temperature, as this will bake the pastries more evenly. Bake delicate pastries on one level using  top/bottom heating. Even excess greaseproof paper can affect the air circulation. Always cut the greaseproof paper down to the size of the baking tray.

The bottom of a fruit pie is too light. The fruit juice overflows.

Next time, use the deeper universal pan.

You have used more than one level. The pastries are darker on the upper baking tray than on the lower baking tray.

Always use  3D hot air to bake on more than one level. Food on baking trays put into the oven at the same time will not necessarily be ready at the same time.

Condensation forms when you bake moist cakes.

Steam can form during baking. Depending on the oven, it will either escape above the oven door or through the steam outlet on the hob. The steam can condense on the appliance or on the front of adjacent cabinets and drip off as condensation. This is due to the laws of physics.

Meat, poultry, fish

Ovenware

You may use any heat-resistant dishes. The universal pan is also suitable for larger roasts.

Always place the dishes in the centre of the wire grill.

Hot glass dishes should be placed on a dry kitchen towel after being removed from the oven. The glass could crack if placed on a cold or wet surface.

Advice on roasting

The roasting result depends on the type and quality of meat.

Add 2 to 3 soup spoons of liquid to lean meat, and 8 to 10 soup spoons of liquid to pot roasts, depending on the size.

Meat should be turned half way through the cooking time.

When the roast is ready, switch off the oven and leave the roast to stand for 10 minutes with the oven door closed. This allows the meat juices to distribute more favourably.

Advice on grilling

Always close the oven door when grilling.

If possible, use pieces of meat which are of the same thickness. They should be at least 2 to 3 cm thick. Such pieces will be browned evenly and stay juicy and soft in the middle. Only salt the steaks after they have been grilled.













Place the pieces of meat directly onto the wire grill. If you are grilling just one piece of meat, it will turn out best if you place it in the centre of the wire grill. You should also insert the universal pan at level 1. The meat juices are collected here and the oven is kept clean.









Turn the pieces of meat after two thirds of the cooking time indicated.

The grill element automatically switches itself off and back on again. This is normal. The number of times this happens depends on the grill setting you have selected.

Meat

The table applies to insertion into a cold oven. The time specifications are provided as guidelines only and depend on the type and quality of the meat.

Meat	Weight	Ovenware	Level	Type of heating	Temperature in °C, grill	Cooking time in minutes
Beef pot roast (e.g. ribs)	1 kg	Covered	2		200-220	120
	1.5 kg		2		190-210	140
	2 kg		2		180-200	160
Sirloin of beef	1 kg	Uncovered	2		210-230	70
	1.5 kg		2		200-220	80
	2 kg		2		190-210	90
Sirloin, medium-rare*	1 kg	Uncovered	1		210-230	50
Steaks, well done		Wire grill***	5		3****	20
Steaks, medium rare		Wire grill***	5		3****	15
Pork without rind (e.g. neck)	1 kg	Uncovered	1		200-220	100
	1.5 kg		1		190-210	140
	2 kg		1		180-200	160

Meat	Weight	Ovenware	Level	Type of heating	Temperature in °C, grill	Cooking time in minutes
Pork with rind** (e. g. shoulder, leg)	1 kg	Covered	1		200-220	120
	1.5 kg		1		190-210	150
	2 kg		1		180-200	180
Smoked pork on the bone	1 kg	Covered	2		210-230	70
Meat loaf	750 g	Uncovered	1		170-190	70
Sausage	approx. 750 g	Wire grill***	4		3	15
Roast veal	1 kg	Uncovered	2		190-210	100
	2 kg		2		170-190	120
Leg of lamb without bone	1.5 kg	Uncovered	1		150-170	120

* Turn roast beef after half the cooking time. After cooking, wrap the sirloin in aluminium foil and leave in the oven to stand for 10 minutes.

** Make cuts in the pork rind and place the pork in the dish if the pork is to be turned, first place the pork with the rind side down.

*** Insert the universal pan at level 1.

**** Preheat the grill for approximately 3 minutes.

Poultry

The table applies to dishes placed in a cold oven.

The weights indicated in the table refer to oven-ready poultry (without stuffing).

If you are grilling directly on the wire rack, you should also insert the universal pan at level 1.

Pierce the skin of duck or goose under the wings to enable the fat to run off.

Turn whole poultry after two thirds of the grilling time.

Poultry will turn out particularly crispy and brown if you baste it towards the end of the roasting time with butter, salted water or orange juice.

Poultry	Weight	Ovenware	Level	Type of heating	Temperature in °C	Cooking time in minutes
Chicken halves, 1 to 4	400 g each	Wire rack	2		200-220	40-50
Chicken pieces	250 g each	Wire rack	2		200-220	30-40
Whole chickens, 1 to 4	1 kg each	Wire rack	2		190-210	50-80
Duck	1.7 kg	Wire rack	2		170-190	90-100
Goose	3 kg	Wire rack	2		150-170	110-130
Young turkey	3 kg	Wire rack	2		170-190	80-100
2 turkey drumsticks	800 g each	Wire rack	2		180-200	90-110

Fish

The table applies to dishes placed in a cold oven.

Fish	Weight	Ovenware	Level	Type of heating	Temperature in °C, grill setting	Duration, minutes
Fish, grilled	300 g each		3		2	20-25
	1 kg	Wire rack*	2		180-200	45-50
	1.5 kg		2		170-190	50-60
Sliced fish (e.g. fish steaks)	300 g each	Wire rack*	4		2	20-25







* Insert the universal pan at level 1.



Tips for roasting and grilling

The table does not contain information for the weight of the roast.	Select the next lowest weight from the instructions and extend the time.
How can you tell when the roast is ready?	Use a meat thermometer (available from specialist shops) or carry out a "spoon test". Press down on the roast with a spoon. If it feels firm, it is ready. If the spoon can be pressed in, it needs to be cooked for a little longer.
The roast is too dark and the crackling is partly burnt.	Check the shelf position and temperature.
The roast looks good, but the juices are burnt.	Next time, use a smaller roasting dish or add more liquid.
The roast looks good, but the juices are too clear and watery.	Next time, use a larger roasting dish or add less liquid.
Steam rises from the roast when the juice is basted.	Use hot air grilling instead of top/bottom heating. This prevents the bottom of the roast from becoming too hot, thereby producing less steam.

Bakes, gratins, toast

The table applies to dishes placed in a cold oven.

Meal	Ovenware	Level	Type of heating	Temperature in °C, grill	Cooking time in minutes
Sweet bakes (e.g. quark and fruit bake)	Casserole dish	2		180-200	40-50
Savoury bakes made from cooked ingredients (e.g. pasta bake)	Casserole dish, universal pan	2		210-230	30-40
		2		210-230	20-30
Savoury bakes made from raw ingredients* (e.g. potato gratin)	Casserole dish or universal pan	2		150-170	50-60
		2		150-170	50-60
Toast	Wire rack	5		3	6-7
		5		3	4-5

Meal	Ovenware	Level	Type of heating	Temperature in °C, grill	Cooking time in minutes
Toast with topping	4 pieces	4		3	7-10
	12 pieces	4		3	5-8















* The bake must be no higher than 2 cm.

** Always insert the universal pan at level 1.

Frozen foods

Please observe the instructions on the packaging.

The values in the table apply to dishes placed in a cold oven.

Meal	Use for	Level	Type of heating	Temperature in °C	Cooking time in minutes
Pizza	Pizza with a thin base	3		190-210	15-20
	Pizza with a thick base	2		170-190	20-30
	Pizza baguette	2		180-200	20-30
	Mini pizza	3		190-210	10-20
Potato products	Chips	2		190-210	20-30
	Croquettes	2		190-210	20-30
	Duchess potatoes	2		190-210	20-30
	Fried potatoes	2		190-210	15-25
	Filled potato skins	2		190-210	15-25
Baked goods	Rolls	3		190-210	10-20
	Pretzels	3		200-220	10-20
Fried foods	Fish fingers	2		200-220	10-15
	Chicken nuggets	2		190-210	10-20
	Vegetable burgers	2		180-200	15-25

Special dishes

Your appliance can be set to temperatures between 50 and 300 °C. 50 °C is equally useful for producing creamy yoghurt as it is for light yeast dough.



Yoghurt

Bring the milk (3.5 % fat) to the boil, then allow to cool to 50 °C. Stir in 150 g of yoghurt. Pour into cups or small screw-lid jars, then cover and place them on the wire rack. Preheat for 5 minutes to 50 °C, then prepare as indicated.

Proving dough

Prepare the yeast dough as per usual. Place it in a heat-resistant ceramic dish and cover. Preheat the cooking compartment for 5 minutes. Switch off the appliance and leave the dough to prove in the cooking compartment.

Preparation

Dish	Ovenware	Level	Type of heating	Temperature in °C	Cooking time
Yoghurt	Place the cups or screw-lid jars on the wire rack	1		50	6-8 hrs
Proving dough	Heat-resistant dish	Place on the cooking compartment floor		Preheat to 50 °C, switch off the appliance, place the yeast dough in the cooking compartment	5 mins 20-30 mins

Defrosting

Remove the food from its packaging and place it in a suitable dish on the wire grill.

Please observe the instructions on the packaging.

The defrosting times depend on the type and amount of food.

Meal	Accessories	Level	Type of heating	Temperature in °C
Frozen foods* e.g. cream gateaux, cream cakes, cakes with chocolate or icing, fruit, chicken, sausages and meat, bread, rolls, pastries and other baked goods	Wire rack	2		The temperature selector remains switched off





* Cover frozen food with microwave foil. Place poultry onto the plate with the breast side down.

Drying

Only use perfectly fresh fruit and vegetables, and wash them thoroughly.

Allow the food to drain well and dry it yourself.

Line the universal pan and wire rack with baking paper or greaseproof paper.

Meal	Level	Type of heating	Temperature in °C	Cooking time in hours
600 g apple rings	1 + 3		80	Approx. 5
800 g sliced pears	1 + 3		80	Approx. 8
1.5 kg prunes or plums	1 + 3		80	Approx. 8 - 10
200 g fresh herbs, washed	1 + 3		80	Approx. 1½

Note

Very moist fruit or vegetables should be turned several times. Once dried, remove the food from the paper immediately.



Tips for saving energy

in the oven

Only preheat the oven if this is specified in the recipe or in the operating instructions table.

Use dark, black lacquered or enamelled baking tins. They absorb the heat particularly well.

It is best to bake several cakes one after the other. The oven is still warm. This reduces the baking time for the second cake. You can also place two cake tins next to each other.

For longer cooking times, you can switch the oven off 10 minutes before the end of the cooking time and use the residual heat to finish cooking.

on the hob

Always use a saucepan which is the correct size for your food. A larger, less full saucepan requires more energy.

Always place a suitable lid on the saucepan.

Switch to a lower heat setting in good time.

The gas flame must always be in contact with the base of the saucepan.

Acrylamide in foodstuffs

Which foods are affected? Acrylamide is mainly produced in grain and potato products heated at high temperatures, such as potato crisps, chips, toast, rolls, bread, baked goods (biscuits, gingerbread, cookies).

Tips for keeping acrylamide to a minimum when preparing food











General	Keep cooking times to a minimum. Cook meals until they are golden brown, not too dark. Large, thick pieces of food contain less acrylamide. Potatoes used for roasting and deep-fat frying should be as fresh as possible. You must not use green or sprouting parts of a potato.
Baking	With top/bottom heating, maximum 200 °C, with 3D hot air or hot air, maximum 180 °C.
Biscuits	With top/bottom heating, maximum 190 °C, with 3D hot air or hot air, maximum 170 °C. Egg white and egg yolk reduce the formation of acrylamide.
Oven chips	Spread out a single layer evenly on the baking tray. Bake at least 400 g per baking tray so that the chips do not dry out.
Roasting in the pan	Boil potatoes before roasting them. For raw potatoes, use margarine instead of oil.
Deep-fat frying	Fat should not be hotter than 175 °C. Check the temperature with a fat thermometer. The ratio of food/fat should be between 1:10 and 1:15, e.g. 100 g chips in 1.5 l oil. Soak potatoes for one hour before deep frying.

Test dishes

In accordance with DIN 44547 and EN 60350

Baking

The values in the table apply to dishes placed in a cold oven.

Meal	Accessories and notes	Level	Type of heating	Temperature in °C	Baking time in minutes
Viennese whirls	Baking tray	2		150-170	20-30
	Baking tray + universal pan**	1+3		140-160	30-40
	2 baking trays* + universal pan***	1+3+5		140-160	40-50
Small cakes x 20	Baking tray	3		160-180	20-30
Small cakes, 20 per baking tray (preheat)	Baking tray + universal pan**	1+3		150-170	25-35
	2 baking trays* + universal pan***	1+3+5		150-170	30-40
Swiss roll	Springform cake tin	2		160-180	30-40
Yeast cakes on a baking tray	Universal pan	3		170-190	40-50
	Baking tray + universal pan**	1+3		150-170	50-60
German apple pie	2 wire racks + 2 tinplate springform cake tins Ø 20 cm****	1+3		190-210	70-80
	Universal pan + 2 tinplate springform cake tins Ø 20 cm****	1		200-220	70-80

* Baking trays may be obtained as optional accessories from specialist shops.



** Always place the universal pan above the tray when you are cooking on two levels at once.

*** Always insert the universal pan at the bottom of the oven. This can be removed before cooking.

**** Place the cakes diagonally on the accessories.

Grilling

The values in the table apply to dishes placed in a cold oven.

Meal	Accessories	Level	Type of heating	Grill setting	Cooking time in minutes
Toast (preheat for 10 mins.)	Wire rack	5		3	1-2
Beefburgers, x 12*	Wire rack	4		3	25-30

* Turn after $\frac{2}{3}$ of the time has elapsed. Always insert the universal pan at level 1.

CE

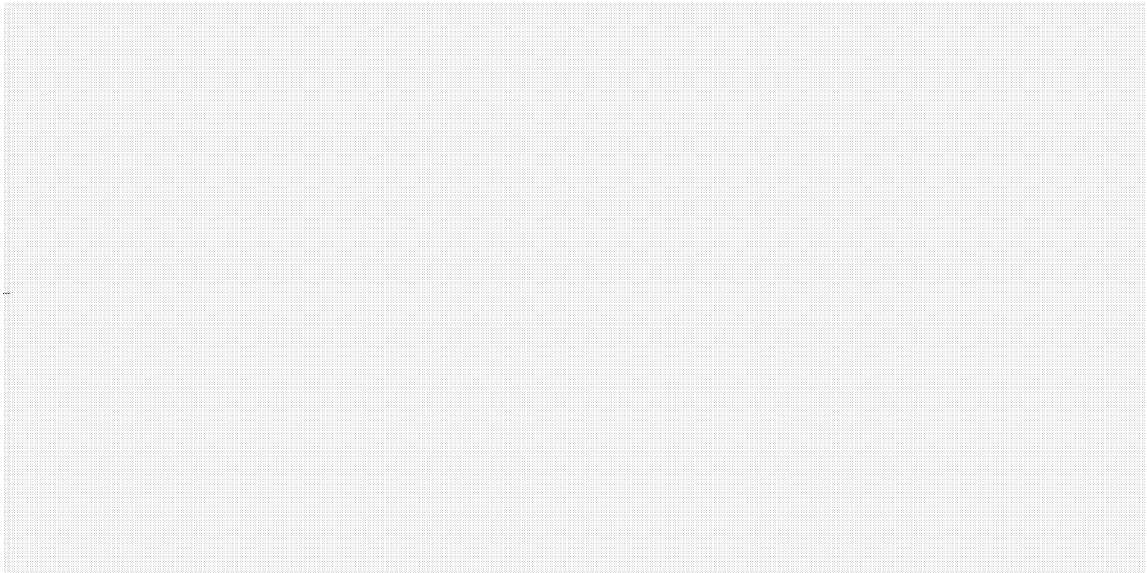
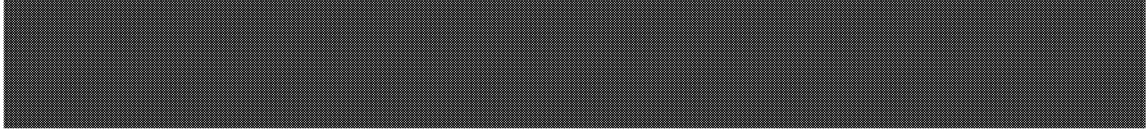

Robert Bosch, Hausgeräte GmbH
Carl-Wery-Straße 34
81739 München
DEUTSCHLAND

9000 458503
BO • en • 060691-04