

# Contents

- Safety instructions ..... 1
- Connections on the dryer ..... 2
- Notes on installation ..... 3
- Installation options ..... 4
- Notes on installation ..... 6
- Installing more than one dryer ..... 7

## ! Safety instructions

- We recommend that you route the exhaust air directly into the open air through an exhaust air duct.
  - Where an exhaust air duct is routed to the open air, a drain check valve must be fitted (prevents air from flowing back).
  - Only install the air extraction system as described in these instructions.
  - The air extraction system must not exceed the specified pressure losses, see page 3.
  - Only use materials and parts specified in the instructions.
  - Clean the exhaust air duct regularly, at least once a year.
- When operating the dryer without an exhaust air duct, the following must also be observed:*
- Ensure that the room is well ventilated, otherwise energy consumption and drying time will increase.
  - Ensure that the room is well ventilated → risk of damage caused by moisture, e.g. to walls, furniture.
  - Do not cover the exhaust air opening (leave approx. 1 m of free space around the exhaust air opening).

# Connections on the dryer

Connections for an exhaust air duct are located on the back panel and on the left side panel of the dryer.

## 1. Back panel connection

The exhaust air opening on the back panel is open when the dryer is delivered (bayonet ring). The exhaust air opening on the left side panel is sealed with a cover.

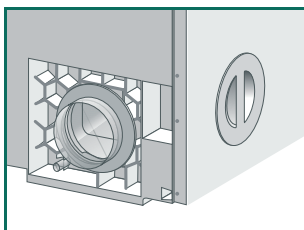

## 2. Left side panel connection

1. Remove the cover on the side panel.

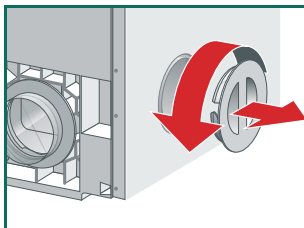

2. Remove the bayonet ring from the back panel and attach it to the opening on the side panel.

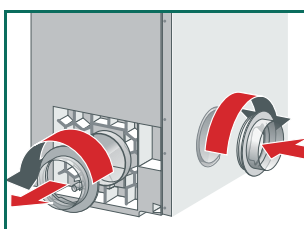

3. Seal the opening in the back panel with the cover.

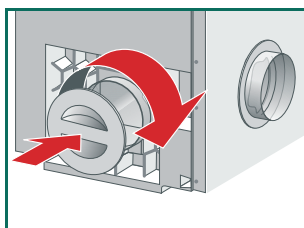

## Condensation outlet

If there is a high level of condensation in the exhaust air duct, it is advisable to fix a condensation collector (standard) or a drain hole with a diameter of approximately 3 mm to the lowest part of the exhaust air duct.

# Notes on installation

## Exhaust air duct

All standard products can be used for the exhaust air duct:

- flexible pipes
- galvanised metal ducts or pipes
- connectors, adapters, and diverters for flat duct systems and pipe systems
- wall boxes for evaporation into the open air or into a ventilation shaft
- adapters on rectangular ducts
- rectangular ducts or plastic pipes
- backpressure flap

The material must be heat resistant up to 80 °C and moisture resistant.

## Pressure losses

The type and length of the exhaust air duct, particularly elbows or bends with small radii, can impede the air flow. → Keep diameter reductions and pressure losses (resistance) to a minimum.

The following must be avoided:

- long exhaust air ducts
- exhaust air ducts with small diameters
- exhaust air ducts with many bends and elbows.

## Pressure losses through friction

Duct or pipe friction resistance, i.e. friction on the inside of the exhaust air duct, affects the air flow as follows:

- the smoother the internal wall
  - the larger the diameter of the internal wall
  - the shorter the pipe
- the lower the friction resistance.

## Pressure losses due to fixtures

The exhaust air encounters further resistance through fixtures built into the pipe, e.g. diverters (bends, elbows, angles), wall boxes with grids or backpressure flaps.

## Installation for pipe connection - inside diameter = 100 mm

In order to ensure the minimum required air flow, a certain pressure loss (resistance) must not be exceeded.

The permissible total pressure loss in an exhaust air duct must not exceed a certain value. This is calculated as the sum of all individual pressure loss values for the straight pieces and fixtures in the exhaust air duct.

The value for the maximum permissible total pressure loss for an exhaust air duct is 50\*.

## Installation for pipe connection - inside diameter = 100 mm

If the pipe connection has an inside diameter > 100 mm and a total pressure loss greater than 50\*, increase the inside diameter of the pipe connection

\* To determine the total pressure loss see table → page 6.

# Installation options

- ! - Route the exhaust air duct in such a way that the dryer cannot draw the moist, warm exhaust air back in again.
- The outlet for the exhaust air must be designed or positioned in such a way as to prevent any additional backpressure (e.g. from a direct ingress of wind) on the escaping exhaust air, e.g. by using a 90° bend, facing down → page 7.
- The outlet for the exhaust air duct must be no more than 2.5 m higher than the exhaust air opening on the appliance.

## Installation options for the exhaust air duct:

### 1. Through a wall box into the open air

Example: pipe connection - inside diameter = 100 mm, smooth

A = straight piece (1.0 m)	4
B = curved pipe (R = 200 mm)	4
C = straight piece (1.5 m)	6
D = pipe elbow	19
E = telescopic wall box with grid	14
<b>Total pressure loss</b>	<b>47</b>

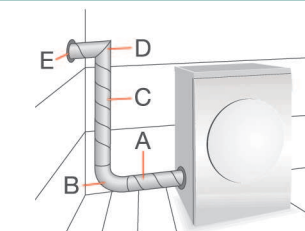

### 2. Directly into the open air

Route the exhaust air directly into the open air via an exhaust air pipe through an open window.

Example:

Pipe connection - inside diameter = 100 mm, flexible pipe, corrugated

A = curved pipe (R = 300 mm)	7
B = straight piece (1.5 m)	18
C = curved pipe (R = 100 mm)	10
D = straight piece (0.5 m)	6
<b>Total pressure loss</b>	<b>41</b>

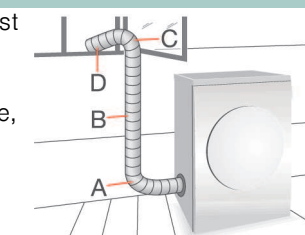

### 3. Through a wall box into chimneys or ventilation shafts

- ! - It is not permitted to connect the exhaust air duct to chimneys which are connected to gas or coal-fired ovens/cookers or gas-fired heating systems.
- If the appliance is being connected to a moisture-insulated ventilation shaft the responsible chimney sweep must be informed and the approval of the local building department (building supervision office) or the owner of the building must be obtained.
- If other appliances are operated in the room where the appliance is installed or in adjoining rooms, e.g. gas-fired heating systems, gas-fired boilers, coal-fired ovens connected to a chimney, or open fireplaces, a vacuum may be created, leading to waste gases being sucked back → **risk of poisoning**.
- In every case, have safe operation confirmed by the responsible chimney sweep, boiler engineer, ventilation specialist, etc.

## Notes on installation

### Individual pressure loss values

Internal wall	Pipe connection diameter > 100 mm			Flat duct connection	
	Pipe, smooth	Flexible pipe, grooved	Flexible pipe, corrugated	110 x 54 smooth	220 x 54 smooth
Model variant straight piece per 1 m length	4	6	12	10	3

### Fixtures

Bend	R = 300 mm	3	5	7	6	3
		R = 200 mm	4	7	8	8
R = 100 mm	6	9	10	12	6	
Diverters	Angle	10	16	17	26	8
		Elbow	19	22	24	> 50
Telescopic wall box with grid			14			28
Wall box with backpressure flap		6			13	3

### Total pressure loss values

Total pressure loss	Pipe connection
0 - 50	100
0 - 80	110
0 - 124	120
0 - 186	130

9203 / 9000170309



## Installing more than one dryer

Up to 7 exhaust air dryers can be connected to an intercepting pipe with a smooth internal wall.



The following points **MUST** be observed:

- It is imperative that there are drain check valves in the interception pipe for every dryer. These valves prevent the moist exhaust air from flowing back into the washing and drying room through dryers which are not in operation.
- The outlet for the exhaust air must be arranged/routed in such a way as to prevent any additional backpressure (e.g. from a direct ingress of wind) on the escaping exhaust air.
- In every case, have safe operation confirmed by the responsible ventilation engineer/installer.



When connecting to the interception pipe, avoid the following:

- mutual interference between dryers
- discharge of moisture in the washing and drying room
- higher pressure losses (increase in energy consumption and time)
- The exhaust air ducts of the individual dryers ( $DT = R \geq 100$  mm) should already be extended to the dimension of the interception pipe upstream of the drain check valves.
- Possible backpressure (e.g. caused by wind ingress) can be minimised by using a  $90^\circ$  bend, facing down.

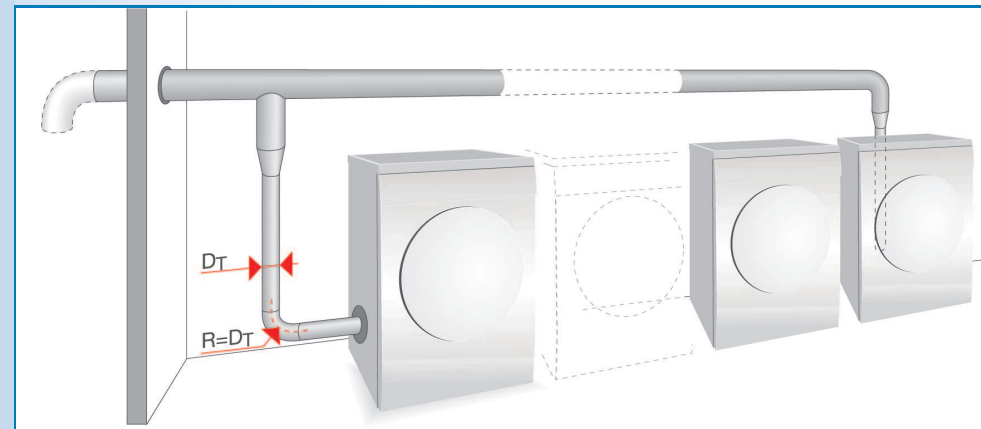

## Exhaust air duct for tumble dryer



Installation instructions



Do not operate the exhaust air duct until you have read these instructions. Please also observe the separate instruction manual for the exhaust air dryer. Keep all the documents in a safe place for future reference, or to pass on to the next owner.

# Contents

■ Safety instructions .....	1
■ Connections on the dryer .....	2
■ Notes on installation .....	3
■ Installation options .....	4
■ Notes on installation .....	6
■ Installing more than one dryer .....	7



## Safety instructions

- We recommend that you route the exhaust air directly into the open air through an exhaust air duct.
- Where an exhaust air duct is routed to the open air, a drain check valve must be fitted (prevents air from flowing back).
- Only install the air extraction system as described in these instructions.
- The air extraction system must not exceed the specified pressure losses, see page 3.
- Only use materials and parts specified in the instructions.
- Clean the exhaust air duct regularly, at least once a year.

*When operating the dryer without an exhaust air duct, the following must also be observed:*

- Ensure that the room is well ventilated, otherwise energy consumption and drying time will increase.
- Ensure that the room is well ventilated → risk of damage caused by moisture, e.g. to walls, furniture.
- Do not cover the exhaust air opening (leave approx. 1 m of free space around the exhaust air opening).

## Connections on the dryer

Connections for an exhaust air duct are located on the back panel and on the left side panel of the dryer.

### 1. Back panel connection

The exhaust air opening on the back panel is open when the dryer is delivered (bayonet ring).

The exhaust air opening on the left side panel is sealed with a cover.

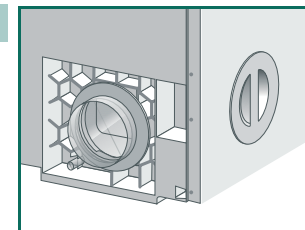

### 2. Left side panel connection

1. Remove the cover on the side panel.

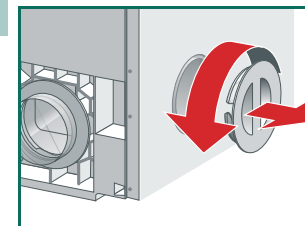

2. Remove the bayonet ring from the back panel and attach it to the opening on the side panel.

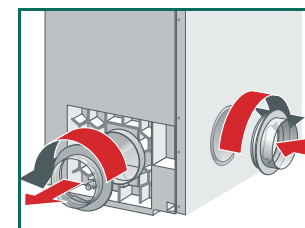

3. Seal the opening in the back panel with the cover.

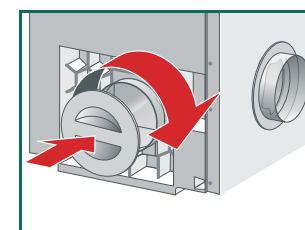

### Condensation outlet

If there is a high level of condensation in the exhaust air duct, it is advisable to fix a condensation collector (standard) or a drain hole with a diameter of approximately 3 mm to the lowest part of the exhaust air duct.



# Notes on installation

## Exhaust air duct

All standard products can be used for the exhaust air duct:

- flexible pipes
- galvanised metal ducts or pipes
- connectors, adapters, and diverters for flat duct systems and pipe systems
- wall boxes for evaporation into the open air or into a ventilation shaft
- adapters on rectangular ducts
- rectangular ducts or plastic pipes
- backpressure flap

The material must be heat resistant up to 80 °C and moisture resistant.

## Pressure losses

The type and length of the exhaust air duct, particularly elbows or bends with small radii, can impede the air flow. → Keep diameter reductions and pressure losses (resistance) to a minimum.

The following must be avoided:

- long exhaust air ducts
- exhaust air ducts with small diameters
- exhaust air ducts with many bends and elbows.

### Pressure losses through friction

Duct or pipe friction resistance, i.e. friction on the inside of the exhaust air duct, affects the air flow as follows:

- the smoother the internal wall
  - the larger the diameter of the internal wall
  - the shorter the pipe
- the lower the friction resistance.

### Pressure losses due to fixtures

The exhaust air encounters further resistance through fixtures built into the pipe, e.g. diverters (bends, elbows, angles), wall boxes with grids or backpressure flaps.

## Installation for pipe connection - inside diameter = 100 mm

In order to ensure the minimum required air flow, a certain pressure loss (resistance) must not be exceeded.

The permissible total pressure loss in an exhaust air duct must not exceed a certain value. This is calculated as the sum of all individual pressure loss values for the straight pieces and fixtures in the exhaust air duct.

The value for the maximum permissible total pressure loss for an exhaust air duct is 50\*.

## Installation for pipe connection - inside diameter = 100 mm

If the pipe connection has an inside diameter > 100 mm and a total pressure loss greater than 50\*, increase the inside diameter of the pipe connection

\* To determine the total pressure loss see table → page 6.

# Installation options



- Route the exhaust air duct in such a way that the dryer cannot draw the moist, warm exhaust air back in again.
- The outlet for the exhaust air must be designed or positioned in such a way as to prevent any additional backpressure (e.g. from a direct ingress of wind) on the escaping exhaust air, e.g. by using a 90° bend, facing down → page 7.
- The outlet for the exhaust air duct must be no more than 2.5 m higher than the exhaust air opening on the appliance.

## Installation options for the exhaust air duct:

### 1. Through a wall box into the open air

Example: pipe connection - inside diameter = 100 mm, smooth

A = straight piece (1.0 m)	4
B = curved pipe (R = 200 mm)	4
C = straight piece (1.5 m)	6
D = pipe elbow	19
E = telescopic wall box with grid	14
<b>Total pressure loss</b>	<b>47</b>

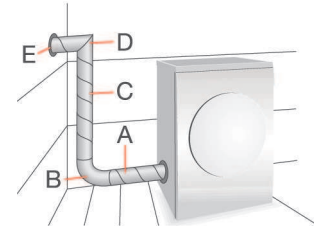

### 2. Directly into the open air

Route the exhaust air directly into the open air via an exhaust air pipe through an open window.

Example:

Pipe connection - inside diameter = 100 mm, flexible pipe, corrugated

A = curved pipe (R = 300 mm)	7
B = straight piece (1.5 m)	18
C = curved pipe (R = 100 mm)	10
D = straight piece (0.5 m)	6
<b>Total pressure loss</b>	<b>41</b>

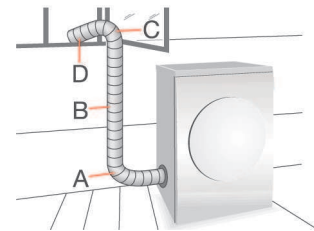

### 3. Through a wall box into chimneys or ventilation shafts







- It is not permitted to connect the exhaust air duct to chimneys which are connected to gas or coal-fired ovens/cookers or gas-fired heating systems.
- If the appliance is being connected to a moisture-insulated ventilation shaft the responsible chimney sweep must be informed and the approval of the local building department (building supervision office) or the owner of the building must be obtained.
- If other appliances are operated in the room where the appliance is installed or in adjoining rooms, e.g. gas-fired heating systems, gas-fired boilers, coal-fired ovens connected to a chimney, or open fireplaces, a vacuum may be created, leading to waste gases being sucked back → **risk of poisoning**.
- In every case, have safe operation confirmed by the responsible chimney sweep, boiler engineer, ventilation specialist, etc.



# Notes on installation



## Individual pressure loss values

Internal wall	Pipe connection diameter > 100 mm			Flat duct connection	
	Pipe, smooth	Flexible pipe, grooved	Flexible pipe, corrugated	110 x 54 smooth	220 x 54 smooth
Model variant					
straight piece per 1 m length	4	6	12	10	3

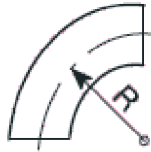
## Fixtures

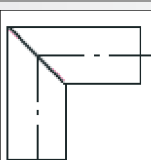
	Bend					
	R = 300 mm	3	5	7	6	3
	R = 200 mm	4	7	8	8	4
	R = 100 mm	6	9	10	12	6
Diverters 	Angle	10	16	17	26	8
		Elbow	19	22	24	> 50
Telescopic wall box with grid		14			28	7
Wall box with backpressure flap		6			13	3



## Total pressure loss values

Total pressure loss	Pipe connection
0 - 50	100
0 - 80	110
0 - 124	120
0 - 186	130

9203 / 9000170309



## Installing more than one dryer

Up to 7 exhaust air dryers can be connected to an intercepting pipe with a smooth internal wall.



The following points **MUST** be observed:

- It is imperative that there are drain check valves in the interception pipe for every dryer. These valves prevent the moist exhaust air from flowing back into the washing and drying room through dryers which are not in operation.
- The outlet for the exhaust air must be arranged/routed in such a way as to prevent any additional backpressure (e.g. from a direct ingress of wind) on the escaping exhaust air.
- In every case, have safe operation confirmed by the responsible ventilation engineer/installer.



**When connecting to the interception pipe, avoid the following:**

- mutual interference between dryers
- discharge of moisture in the washing and drying room
- higher pressure losses (increase in energy consumption and time)
- The exhaust air ducts of the individual dryers ( $DT = R \geq 100$  mm) should already be extended to the dimension of the interception pipe upstream of the drain check valves.
- Possible backpressure (e.g. caused by wind ingress) can be minimised by using a  $90^\circ$  bend, facing down.

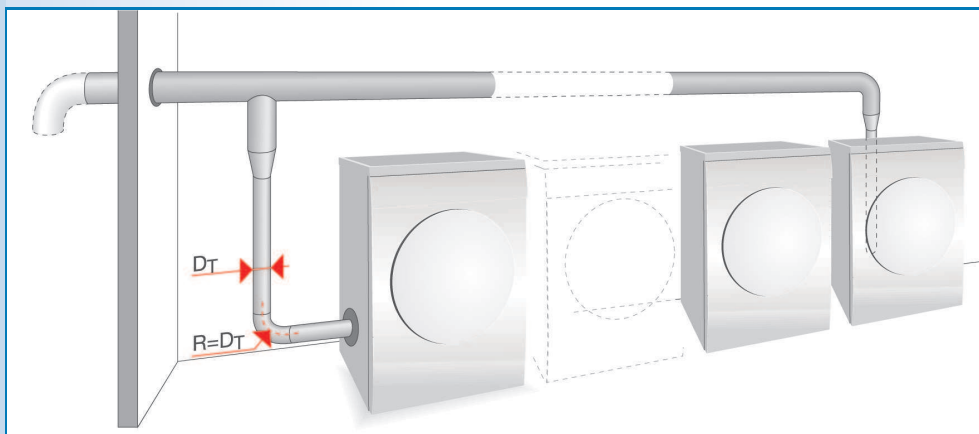

## Exhaust air duct for tumble dryer



Do not operate the exhaust air duct until you have read these instructions. Please also observe the separate instruction manual for the exhaust air dryer. Keep all the documents in a safe place for future reference, or to pass on to the next owner.