





SELF-REPAIR HINTS

[bg]	Съвети за ремонт	2
[hr]	Savjeti za popravak	10
[cs]	Poznámky k opravě	18
[da]	Tip til reparation	26
[nl]	Reparatie informatie	34
[en]	Self-repair hints	42
[et]	Remonditeave	50
[fi]	Korjausvinkit	58
[fr]	Conseils de réparation	66
[de]	Reparatur Hinweise	74
[el]	Υποδείξεις επισκευής	82
[hu]	Javítási útmutató	90
[it]	Consigli di riparazione	98
[lv]	Informācija par remontu	106
[lt]	Informacija apie remontą	114
[no]	Reparasjonstips	122
[pl]	Wskazówki naprawy	130
[pt]	Dicas de resolução	138
[ro]	Indicii pentru reparații	146
[sk]	Poznámky k opravám	154
[sl]	Nasveti za popravilo	162
[es]	Consejos de reparación	170
[sv]	Reparationsinformation	178
[tr]	Onarım İpuçları	186

Съвети за ремонт - Fully automatic espresso machine

 Относно този документ	3
1.1 Важна информация.....	3
1.1.1 Цел.....	3
1.2 Обяснение на символите.....	3
1.2.1 Нива на опасност.....	3
1.2.2 Символи за опасност.....	3
1.2.3 Структура на предупрежденията.....	4
1.2.4 Общи символи.....	4
 Безопасност	5
2.1 Общи инструкции за безопасност.....	5
2.1.1 Всички домашни уреди.....	5
 Инструменти и помощни средства	6
 Ремонт	7
4.1 Отстраняване на задния капак на опорната рамка на отвора за напитки с лампа за чашата и осветлението на изхода за напитка.....	7

i Относно този документ

1.1 Важна информация

1.1.1 Цел

Тези съвети за ремонт помагат на потребителя да ремонтира сам уреди в съответствие с регламента за екологосъобразно проектиране на уредите (от 03.2021 г.).

Те съдържат информация как да сменят определени резервни части, включително предупреждения и рискове.

Ако имате някакви въпроси, моля свържете се с нашия отдел за обслужване на клиенти. Носим отговорност за щети, само ако съветите за ремонт са спазени правилно.

1.2 Обяснение на символите

1.2.1 Нива на опасност

Предупредителните нива се състоят от символ и сигнална дума. Сигналната дума показва сериозността на опасността.





Ниво на предупреждение	Значение
 ОПАСНОСТ	Неспазването на предупредителното съобщение ще доведе до смърт или сериозни наранявания.
 ПРЕДУПРЕЖДЕНИЕ	Неспазването на предупредителното съобщение може да доведе до смърт или сериозни наранявания.
 ВНИМАТЕЛНО	Неспазването на предупредителното съобщение може да доведе до леки наранявания.
 ВНИМАНИЕ!	Неспазването на предупредителното съобщение може да доведе до имуществени щети.

Таблица 1: Нива на опасност

1.2.2 Символи за опасност

Символите за опасност са символични изображения, които дават индикация за вида опасност.

В този документ се използват следните символи за опасност:

Символ за опасност	Значение
	Общо предупредително съобщение
	Опасност от електрическо напрежение
	Риск от експлозия
	Опасност от порязвания

i Относно този документ





Символ за опасност	Значение
	Опасност от премазване
	Опасност от горещи повърхности
	Опасност от силно магнитно поле
	Опасност от нейонизиращо лъчение

Таблица 2: Символи за опасност

1.2.3 Структура на предупрежденията

Предупрежденията в този документ имат стандартизиран външен вид и стандартизирана структура.

	<p>ОПАСНОСТ</p> <p>Вид и източник на опасността! Възможни последици от игнориране на опасността/предупреждението.</p> <ul style="list-style-type: none"> ▶ Мерки и забрани за предотвратяване на опасността.
----------------------------------------------------------------------------------	-----------------------------------------------------------------------------------------------------------------------------------------------------------------------------------------------------------------------------------------------

Следният пример показва предупреждение, което уведомява за токов удар, предизвикан от части под напрежение. Споменава се мярката за избягване на опасността.

	<p>ОПАСНОСТ</p> <p>Риск от токов удар поради части под напрежение! Смърт от токов удар</p> <ul style="list-style-type: none"> ▶ Изключете уредите от електрическото захранване поне 60 секунди преди започване на ремонта.
------------------------------------------------------------------------------------	-------------------------------------------------------------------------------------------------------------------------------------------------------------------------------------------------------------------------------------------------------------

1.2.4 Общи символи

В този документ се използват следните общи символи:







Общ символ	Значение
	Идентифициране на специален съвет (текст и/или графика)
	Идентифициране на прост съвет (само текст)
	Идентифициране на връзка към видео урок
	Идентифициране на необходимите инструменти
	Идентифициране на необходимите предварителни условия
	Идентифициране на условие (ако ..., тогава ...)
	Идентифициране на резултат
Старт	Идентифициране на ключ или бутон
[00123456]	Идентифициране на каталожен номер
Статус	Идентифициране на показания текст/прозорец (на дисплея на уреда)

Таблица 3: Общи символи

2.1 Общи инструкции за безопасност

2.1.1 Всички домашни уреди

Риск от токов удар поради части под напрежение!

- Грешки при ремонти, включващи електрически компоненти, могат да доведат до токов удар!
- Разкачете уреда от електрическата мрежа за поне 60 секунди, преди да започнете работа.
- След ремонта трябва да се извърши проверка за безопасност съгласно VDE 0701 или в съответствие със специфичните за страната разпоредби.

Риск от нараняване от остри ръбове!

- Носете предпазни ръкавици.

Риск от премазване по време на ремонт, поддръжка, отстраняване на неизправности и сервиз поради тежки и движещи се компоненти

- Носете защитни обувки.
- Закрепете тежките компоненти, така че да не паднат.
- Не позволявайте контакт на части от тялото с движещи се компоненти.

Риск за безопасността/функцията на уреда!

- Използвайте само оригинални резервни части.

Риск от повреда на електростатично чувствителни компоненти (ESD)!

- Не докосвайте модулите, включително връзки и проводникови пътища.

Инструменти и помощни средства

посочване	Подробности	Изображения
Накрайник Torx TX10 [00340864]	6,3 mm (1/4")	



4.1 Отстраняване на задния капак на опорната рамка на отвора за напитки с лампа за чашата и осветлението на изхода за напитка



Специални инструменти:

 Накрайник Torx TX10 6,3 mm (1/4") [00340864]

	<p>Вашият уред е снабден с LED осветление, което не изисква поддръжка.</p> <p>Това осветление може да бъде ремонтирано само от специалисти от службата за обслужване на клиенти или от квалифицирани техници!</p>
-----------------------------------------------------------------------------------	-------------------------------------------------------------------------------------------------------------------------------------------------------------------------------------------------------------------

	 ОПАСНОСТ
	<p>Риск от токов удар поради части под напрежение!</p> <p>Опасност за живота от токов удар в случай на неправилен ремонт</p> <ul style="list-style-type: none"> ▶ Електрическите части трябва да се ремонтират от квалифицирани електротехници. ▶ След ремонта трябва да се извърши проверка за безопасност съгласно VDE 0701 или в съответствие със специфичните за страната разпоредби.

	 ОПАСНОСТ
	<p>Риск от токов удар поради части под напрежение!</p> <p>Смърт от токов удар</p> <ul style="list-style-type: none"> ▶ Изключете уредите от електрическото захранване поне 60 секунди преди започване на ремонта.

	 ВНИМАТЕЛНО
	<p>Остри ръбове!</p> <p>Наранявания от порязване</p> <ul style="list-style-type: none"> ▶ Носете предпазни ръкавици.

	ВНИМАНИЕ!
	<p>Риск от повреда на електростатично чувствителни компоненти (ESD)!</p> <p>Повреда на компоненти</p> <ul style="list-style-type: none"> ▶ Преди да докоснете електростатично чувствителни компоненти, използвайте електростатична защитна система (лента за ръка със заземителен куплунг). ▶ Не докосвайте връзките и проводникови пътища на модулите. ▶ Транспортирайте ESD компоненти само в проводящи материали или оригинални опаковки. ▶ Дръжте ESD компонентите далеч от електростатично зареждащи се материали (напр. пластмаса).

Изискване:

 Уредът е изключен от захранването.

1. Отворете предната врата на уреда.

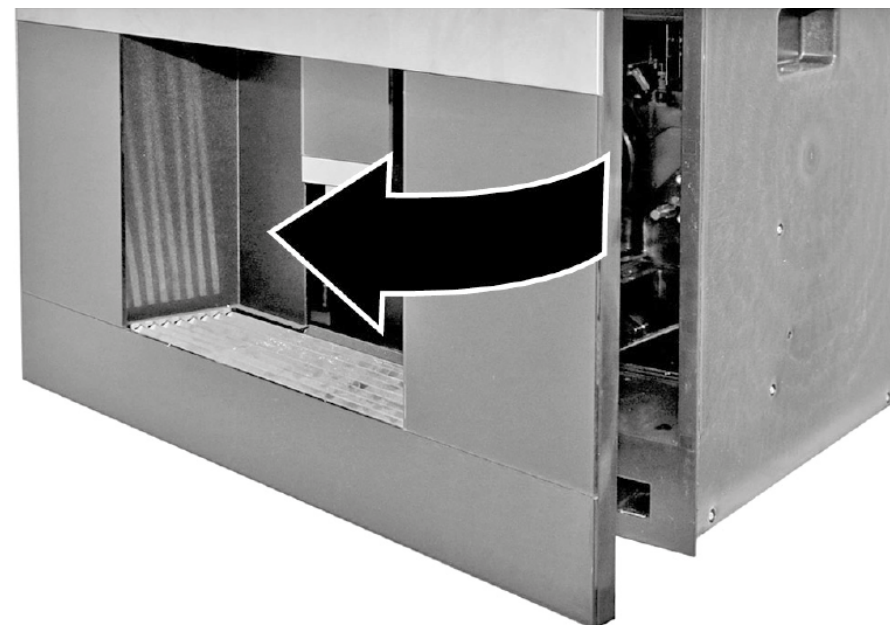

2. Издърпайте и извадете капака на отвора за напитки.

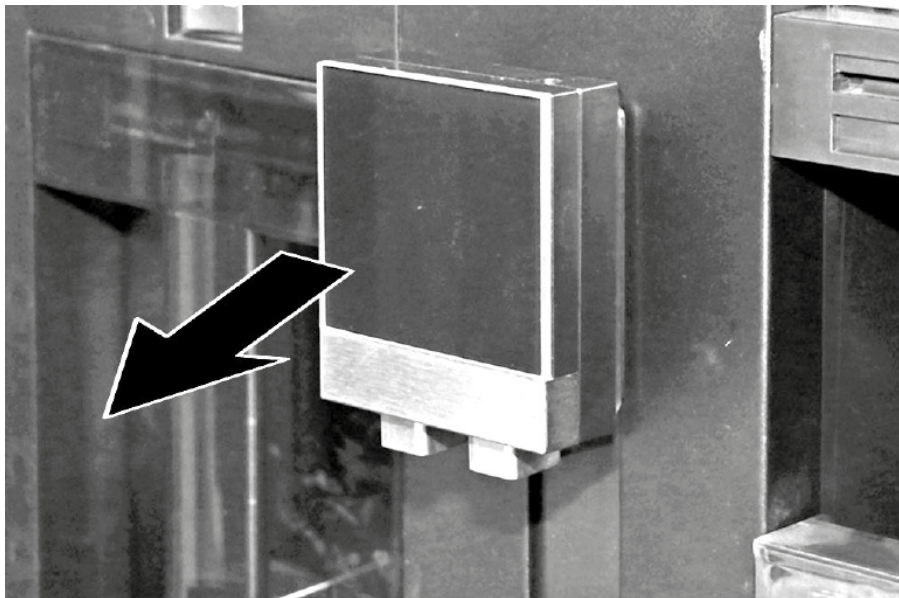

3. Издърпайте навън и извадете диспенсъра на отвора за напитки.

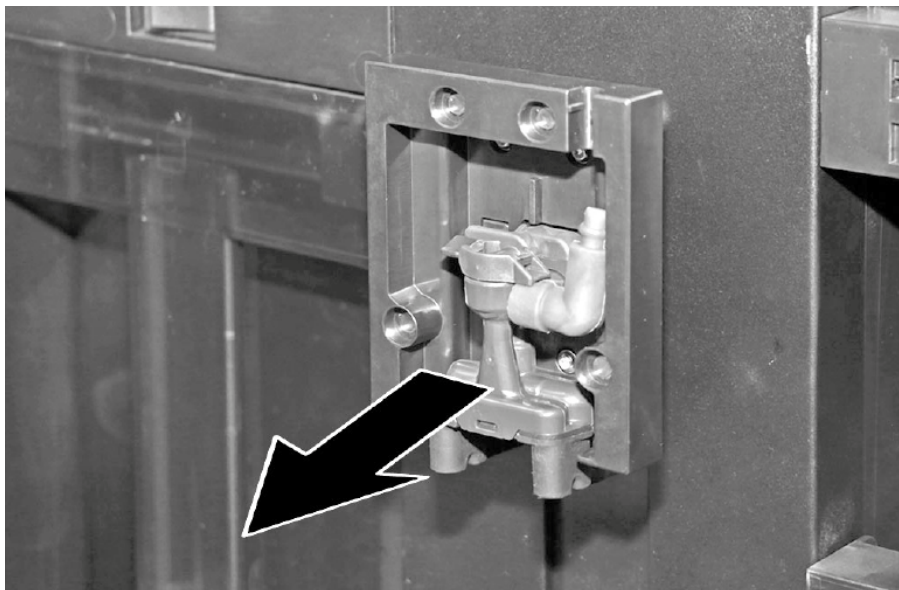

4. Развийте четирите винта на опорната рамка на отвора.

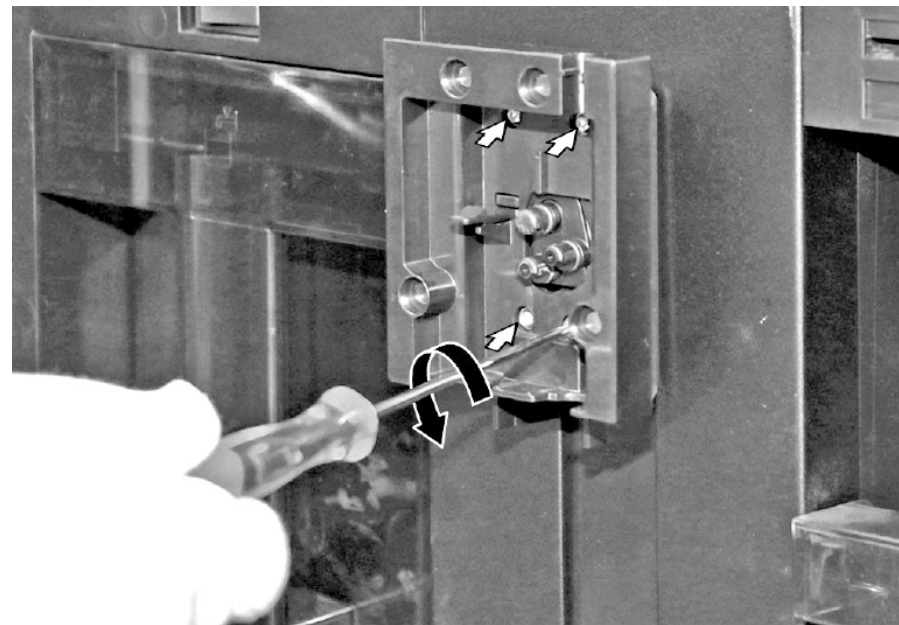



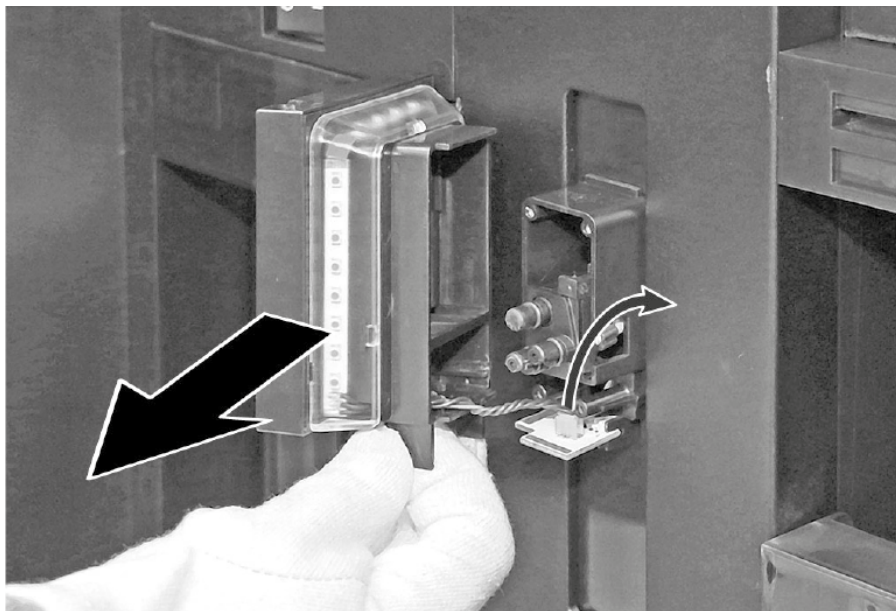

5. Издърпайте опорната рамка на отвора, разединете електрическия конектор и отстранете опорната рамка на отвора.



- ➡ Задният капак на опорната рамка на отвора за напитки с лампа за чашата и осветлението на изхода за напитка е отстранен.

Savjeti za popravak - Potpuno automatizirani aparat za kavu

 O ovom dokumentu	11
1.1 Važne informacije	11
1.1.1 Svrha	11
1.2 Objašnjenje oznaka	11
1.2.1 Stupnjevi opasnosti	11
1.2.2 Oznake opasnosti	11
1.2.3 Struktura upozorenja	12
1.2.4 Opće oznake	12
 Sigurnost	13
2.1 Opće sigurnosne upute	13
2.1.1 Svi kućanski uređaji	13
 Alat i pomagala	14
 Popravak	15
4.1 Uklanjanje stražnjeg poklopca potpornog okvira otvora za napitke sa svjetlom za čašice i rasvjetu odjeljka.....	15

i O ovom dokumentu

1.1 Važne informacije

1.1.1 Svrha

Ove upute za popravak služe kao podrška korisnicima prilikom samostalnog popravljivanja uređaja u skladu s primjenjivom Direktivom o ekološkom dizajnu (od ožujka 2021.).

One sadrže informacije o zamjeni određenih rezervnih dijelova, kao i napomene o upozorenjima i opasnostima.

Ako imate dodatna pitanja, obratite se našoj službi za korisnike. Mi snosimo odgovornost za oštećenja samo u slučaju pridržavanja uputa za popravak.

1.2 Objašnjenje oznaka

1.2.1 Stupnjevi opasnosti

Stupnjevi upozorenja sastoje se od oznake i signalne riječi. Signalna riječ ukazuje na ozbiljnost opasnosti.





Stupanj upozorenja	Značenje
 OPASNOST	Nepridržavanje poruke upozorenja rezultirat će smrtnim ili teškim ozljedama.
 UPOZORENJE	Nepridržavanje poruke upozorenja može rezultirati smrtnim ili teškim ozljedama.
 OPREZ	Nepridržavanje poruke upozorenja može rezultirati lakšim ozljedama.
 POZORI!	Nepridržavanje poruke upozorenja može rezultirati oštećenjem imovine.

Tablica 1: Stupnjevi opasnosti



1.2.2 Oznake opasnosti

Oznake opasnosti simbolička su reprezentacija s oznakom vrste opasnosti.

U ovom dokumentu koriste se sljedeće oznake opasnosti:

Oznaka opasnosti	Značenje
	Opća poruka upozorenja
	Opasnost od električnog napona
	Opasnost od eksplozije
	Opasnost od porezotina
	Opasnost od prignječenja

O ovom dokumentu

Oznaka opasnosti	Značenje
	Opasnost od vrućih površina
	Opasnost od jakog magnetskog polja
	Opasnost od neionizirajućeg zračenja

Tablica 2: Oznake opasnosti

1.2.3 Struktura upozorenja

Upozorenja u ovom dokumentu imaju normirani izgled i strukturu.



	<div style="background-color: red; color: white; padding: 2px; text-align: center;"> OPASNOST</div> <p>Vrsta i izvor opasnosti! Moguće posljedice zanemarivanja opasnosti/upozorenja.</p> <ul style="list-style-type: none">▶ Mjere i zabrane za sprječavanje opasnosti.
----------------------------------------------------------------------------------	-------------------------------------------------------------------------------------------------------------------------------------------------------------------------------------------------------------------------------------------------------------------------------------------------------------------------------------------------------------------------------------------





Sljedeći primjer pokazuje upozorenje na strujni udar od dijelova koji provode struju. Spominje se mjera za izbjegavanje opasnosti.

	<div style="background-color: red; color: white; padding: 2px; text-align: center;"> OPASNOST</div> <p>Opasnost od strujnog udara zbog dijelova koji provode struju! Smrt od strujnog udara</p> <ul style="list-style-type: none">▶ Isključite uređaj iz električnog napajanja najmanje 60 sekundi prije izvođenja popravaka.
-----------------------------------------------------------------------------------	------------------------------------------------------------------------------------------------------------------------------------------------------------------------------------------------------------------------------------------------------------------------------------------------------------------------------------------------------------------------------------------------------------------------------------------------

1.2.4 Opće oznake

U ovom dokumentu koriste se sljedeće opće oznake:

Opća znaka	Značenje
	Oznaka posebnog savjeta (tekst i/ili grafika)
	Oznaka jednostavnog savjeta (samo tekst)
	Oznaka veze na videovodič

Opća znaka	Značenje
	Oznaka potrebnog alata
	Oznaka potrebnih preduvjeta
	Oznaka uvjeta (ako ..., tad ...)
	Oznaka rezultata
Početak	Oznaka tipke ili gumba
[00123456]	Oznaka broja materijala
Status	Oznaka prikazanog teksta / prozor (na zaslonu uređaja)

Tablica 3: Opće oznake

2.1 Opće sigurnosne upute

2.1.1 Svi kućanski uređaji

Opasnost od strujnog udara zbog dijelova koji provode struju!

- Pogreške izazvane popravcima električnih sastavnih dijelova mogu dovesti do strujnog udara!
- Isključite uređaj iz struje na najmanje 60 sekundi prije početka radova.
- Nakon popravka provedite sigurnosni test u skladu s VDE 0701 ili nacionalnim propisima.

Opasnost od ozljeda zbog oštih rubova!

- Nosite zaštitne rukavice.

Opasnost od prignječenja tijekom izvođenja radova na popravcima, održavanju, rješavanju problema i servisiranju teških i pokretnih sastavnih dijelova

- Nosite zaštitnu obuću.
- Osigurajte teške sastavne dijelove od pada.
- Nemojte umetati dijelove tijela u pokretne sastavne dijelove.

Opasnost za sigurnost/rad uređaja!

- Koristite samo originalne rezervne dijelove.

Opasnost od oštećenja elektrostatički osjetljivih sastavnih dijelova (ESD)!

- Nemojte dodirivati module, uključujući priključke i rute vodiča.

Alat i pomagala

Oznaka	Pojedinosti	Slike
Nastavak Torx TX10 [00340864]	6,3 mm (1/4")	

4.1 Uklanjanje stražnjeg poklopca potpornog okvira otvora za napitke sa svjetlom za čašice i rasvjetu odjeljka

Specijalni alati:

🌀 Nastavak Torx TX10 6,3 mm (1/4") [00340864]

 Uređaj ima LED svjetlo koje nije potrebno održavati.
Ta svjetla smiju popravljati samo služba za korisnike i ovlašteni tehničari!

 **OPASNOST**
Opasnost od strujnog udara zbog dijelova koji provode struju!
U slučaju nepravilnog popravka može doći do opasnosti za život od strujnog udara

- ▶ Električne dijelove mora popraviti kvalificirani električar.
- ▶ Nakon popravka provedite sigurnosni test u skladu s VDE 0701 ili nacionalnim propisima.

 **OPASNOST**
Opasnost od strujnog udara zbog dijelova koji provode struju!
Smrt od strujnog udara

- ▶ Isključite uređaj iz električnog napajanja najmanje 60 sekundi prije izvođenja popravaka.

 **OPREZ**
Oštri rubovi!
Porezotine

- ▶ Nosite zaštitne rukavice.

	POZOR!
	<p>Opasnost od oštećenja elektrostatički osjetljivih sastavnih dijelova (ESD)!</p> <p>Oštećenje komponenti</p> <ul style="list-style-type: none"> ▶ Prije nego što dodirnete elektrostatičke osjetljive sastavne dijelove upotrijebite sustav za zaštitu od elektrostatskog naboja (narukvica sa sigurnosnim utikačem za uzemljenje). ▶ Nemojte dodirivati priključke i rute vodiča na modelu. ▶ Elektrostatički osjetljive sastavne dijelove transportirajte samo u vodljivim materijalima ili originalnom pakiranju. ▶ Držite elektrostatički osjetljive sastavne dijelove podalje od materijala koji se mogu elektrostatički puniti (npr. plastike).

Zahtjev:

- ✔ Uređaj je isključen iz napajanja.
1. Otvorite prednja vrata uređaja.

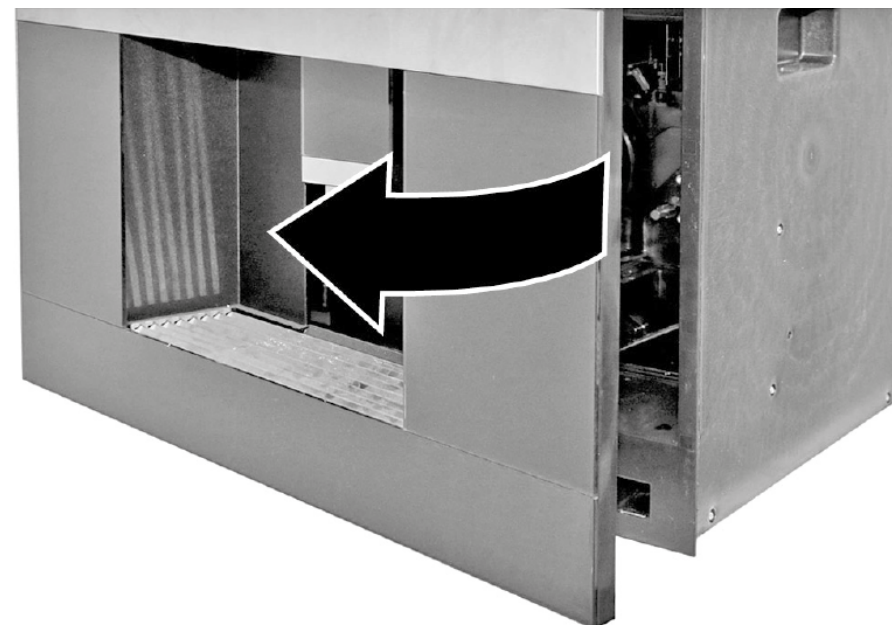

2. Izvucite i skinite poklopac izlaza za napitke.

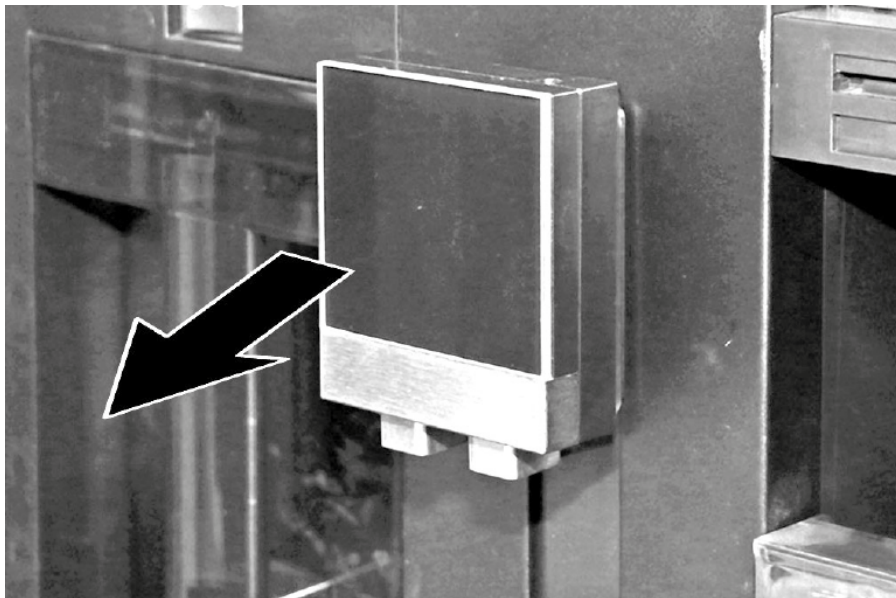

3. Izvucite i izvadite dozator izlaza za napitke.

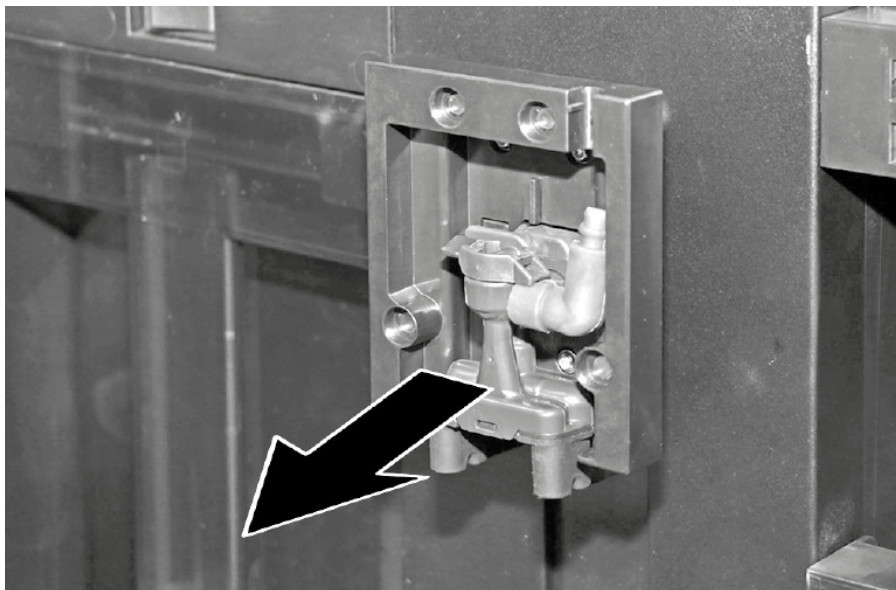

4. Odvijte četiri vijka potpornog okvira izlaza.

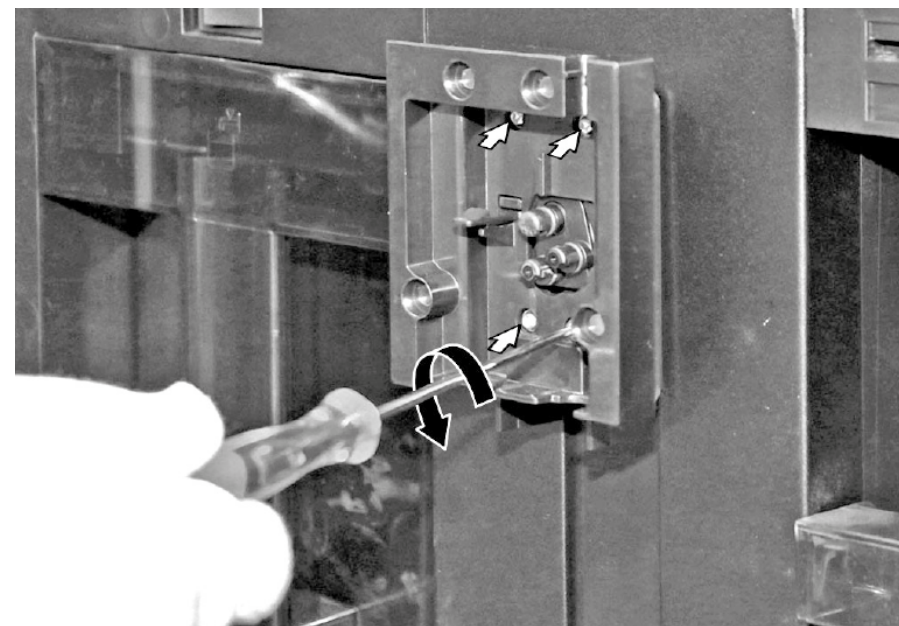

Popravak

5. Izvucite potporni okvir izlaza, odspojite električni konektor i izvadite potporni okvir izlaza.

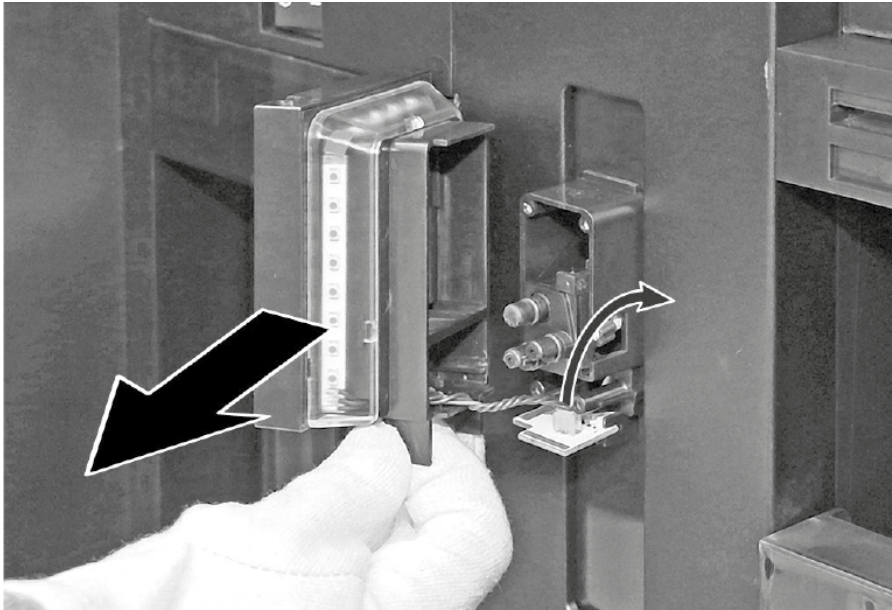

- ➡ Stražnji poklopac potpornog okvira otvora za napitke sa svjetlom za čašice i rasvjetom odjeljka je uklonjen.

Poznámky k opravě - Plně automatický kávovar

 O tomto dokumentu	19
1.1 Důležité informace	19
1.1.1 Účel	19
1.2 Vysvětlení symbolů	19
1.2.1 Úroveň nebezpečí	19
1.2.2 Symboly nebezpečí	19
1.2.3 Struktura výstrah	20
1.2.4 Obecné symboly	20
 Bezpečnost	21
2.1 Všeobecné bezpečnostní pokyny	21
2.1.1 Všechny domácí spotřebiče	21
 Nástroje a pomůcky	22
 Oprava	23
4.1 Odstranění zadního krytu vnějšího podpůrného rámu s osvětlením šálků a reflektorovým osvětlením	23

i O tomto dokumentu

1.1 Důležité informace

1.1.1 Účel

Tyto pokyny k opravě pomáhají spotřebiteli při vlastnoruční opravě spotřebičů v souladu s platnými předpisy o ekodesignu (platnými k 03/2021).



Obsahují informace o výměně některých náhradních dílů včetně příslušných výstrah a nebezpečí.

V případě dotazů se obraťte na náš zákaznický servis. Za škody ručíme pouze v případě, že budou správně dodrženy pokyny k opravě.

1.2 Vysvětlení symbolů

1.2.1 Úroveň nebezpečí

Jednotlivé úrovně výstrah se skládají ze symbolu a signálního slova. Signální slova uvádějí závažnost nebezpečí.





Úroveň výstrahy	Význam
 NEBEZPEČÍ	Nedodržení výstražného upozornění způsobí smrt nebo vážná zranění.
 VÝSTRAHA	Nedodržení výstražného upozornění může způsobit smrt nebo vážná zranění.
 POZOR	Nedodržení výstražného upozornění může způsobit lehká zranění.
POZOR!	Nedodržení výstražného upozornění může způsobit škody na majetku.

Tabulka 1: Úroveň nebezpečí



1.2.2 Symboly nebezpečí

Symboly nebezpečí jsou symbolická znázornění určující druh nebezpečí.

V tomto dokumentu jsou použity následující symboly nebezpečí:

Symbol nebezpečí	Význam
	Obecné výstražné upozornění
	Nebezpečí vycházející z elektrického napětí
	Nebezpečí výbuchu
	Nebezpečí pořezání
	Nebezpečí rozdrcení



O tomto dokumentu

Symbol nebezpečí	Význam
	Nebezpečí spojené s horkými povrchy
	Nebezpečí vycházející ze silného elektromagnetického pole
	Nebezpečí z neionizujícího záření

Tabulka 2: Symboly nebezpečí

1.2.3 Struktura výstrah

Výstrahy použité v tomto dokumentu mají standardizovaný vzhled a strukturu.



	<div style="background-color: red; color: white; padding: 2px; text-align: center;"> NEBEZPEČÍ</div> <p>Typ a zdroj nebezpečí! Možné důsledky nedodržení výstražného upozornění.</p> <ul style="list-style-type: none"> ▶ Opatření a zákazy eliminující nebezpečí.
----------------------------------------------------------------------------------	--------------------------------------------------------------------------------------------------------------------------------------------------------------------------------------------------------------------------------------------------------------------------------------------------------------------------------------------------------------------------------------





Následující příklad ukazuje výstrahu, která varuje před zásahem elektrickým proudem při dotyku dílů pod proudem. Je uvedeno opatření pro zabránění rizika.

	<div style="background-color: red; color: white; padding: 2px; text-align: center;"> NEBEZPEČÍ</div> <p>Nebezpečí úrazu elektrickým proudem při dotyku dílů pod proudem! Usmrcení elektrickým proudem</p> <ul style="list-style-type: none"> ▶ Odpojte spotřebič od přívodu elektrického proudu alespoň 60 sekund před zahájením opravy.
-----------------------------------------------------------------------------------	------------------------------------------------------------------------------------------------------------------------------------------------------------------------------------------------------------------------------------------------------------------------------------------------------------------------------------------------------------------------------------------------------------------------------------------------------------

1.2.4 Obecné symboly

V tomto dokumentu jsou použity následující obecné symboly:

Obecný symbol	Význam
	Uvedení zvláštního tipu (text nebo grafické vyjádření)
	Uvedení jednoduchého tipu (pouze text)
	Uvedení odkazu k videonávodu

Obecný symbol	Význam
	Uvedení požadovaných nástrojů
	Uvedení požadovaných podmínek
	Uvedení podmínky (když, pak atd.)
	Uvedení výsledku
[Start]	Uvedení klávesy nebo tlačítka
[00123456]	Uvedení čísla materiálu
Status	Uvedení zobrazeného textu / okna (na ukazateli spotřebiče)

Tabulka 3: Obecné symboly

2.1 Všeobecné bezpečnostní pokyny

2.1.1 Všechny domácí spotřebiče

Nebezpečí úrazu elektrickým proudem při dotyku dílů pod proudem!

- Chyby při opravě elektrických součástí mohou vést k úrazu elektrickým proudem!
- Odpojte spotřebič ze sítě alespoň 60 sekund před zahájením prací.
- Po opravě nechte provést bezpečnostní zkoušku podle VDE 0701 nebo specifických předpisů dané země.

Nebezpečí poranění o ostré hrany!

- Používejte ochranné rukavice.

Nebezpečí rozdrčení během opravy, údržby, odstranění závad a servisu těžkými a pohyblivými součástmi

- Používejte bezpečnostní obuv.
- Zajistěte těžké součásti před pádem.
- Nesahejte na pohyblivé součásti.

Nebezpečí z hlediska bezpečnosti / funkce spotřebiče!

- Používejte pouze originální náhradní díly.

Nebezpečí poškození elektrostaticky citlivých součástí (elektrostatický výboj)!

- Nedotýkejte se modulů, včetně přípojek a vodičů.

Nástroje a pomůcky

Označení	Detaily	Snímky
Bit torx TX10 [00340864]	6,3 mm (1/4")	

4.1 Odstranění zadního krytu vnějšího podpůrného rámu s osvětlením šálků a reflektorovým osvětlením

Speciální nástroje:

 Bit torx TX10 6,3 mm (1/4") [00340864]

 Váš spotřebič je vybaven bezúdržbovým LED osvětlením. Tato osvětlení smí být opravena pouze zákaznickým servisem nebo oprávněným technikem!

 **NEBEZPEČÍ**
Nebezpečí úrazu elektrickým proudem při dotyku dílů pod proudem!
 V případě neodborné opravy hrozí nebezpečí smrtelného úrazu elektrickým proudem

- ▶ Opravu elektrického zařízení smí provádět jen kvalifikovaný elektrikář.
- ▶ Po opravě nechte provést bezpečnostní zkoušku podle VDE 0701 nebo specifických předpisů dané země.

 **NEBEZPEČÍ**
Nebezpečí úrazu elektrickým proudem při dotyku dílů pod proudem!
 Usmrcení elektrickým proudem

- ▶ Odpojte spotřebič od přívodu elektrického proudu alespoň 60 sekund před zahájením opravy.

 **POZOR**
Ostré hrany!
 Nebezpečí řezných poranění

- ▶ Používejte ochranné rukavice.

 **POZOR!**
Nebezpečí poškození elektrostaticky citlivých součástí (elektrostatický výboj)!
 Poškození součástí

- ▶ Předtím, než se dotknete elektrostaticky citlivých součástí, použijte elektrostatický ochranný systém (ochrannou zemnicí zástrčku).
- ▶ Nedotýkejte se přípojek a vodičů modulů.
- ▶ Elektrostaticky citlivé součásti přepravujte pouze ve vodivých materiálech nebo originálním balení.
- ▶ Elektrostaticky citlivé součásti udržujte mimo materiály schopné elektrostatického nabití (např. plasty).

Požadavek:

-  Spotřebič je odpojený od přívodu elektrické energie.
1. Otevřete přední dvířka spotřebiče.

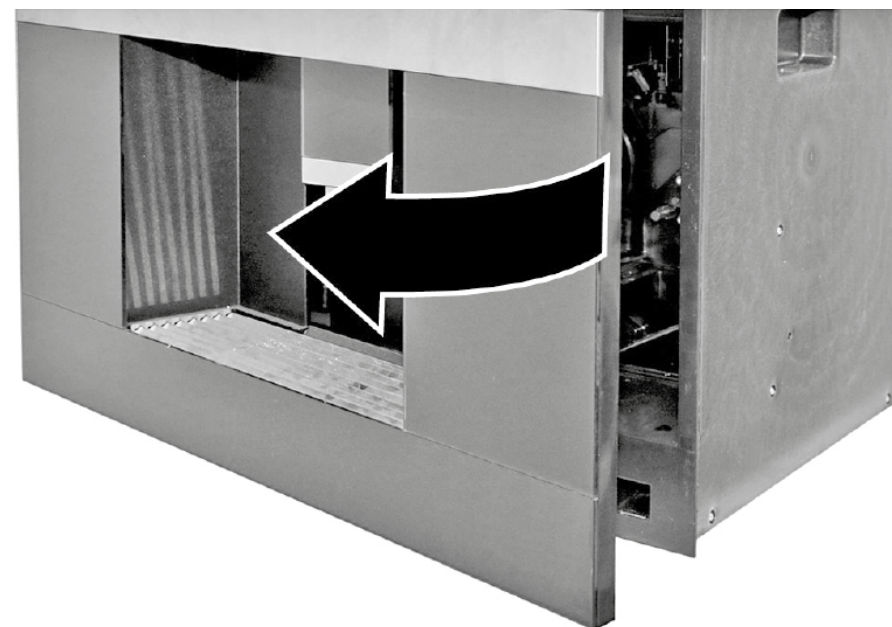

2. Vytáhněte a odeberte kryt výpusti nápoje.

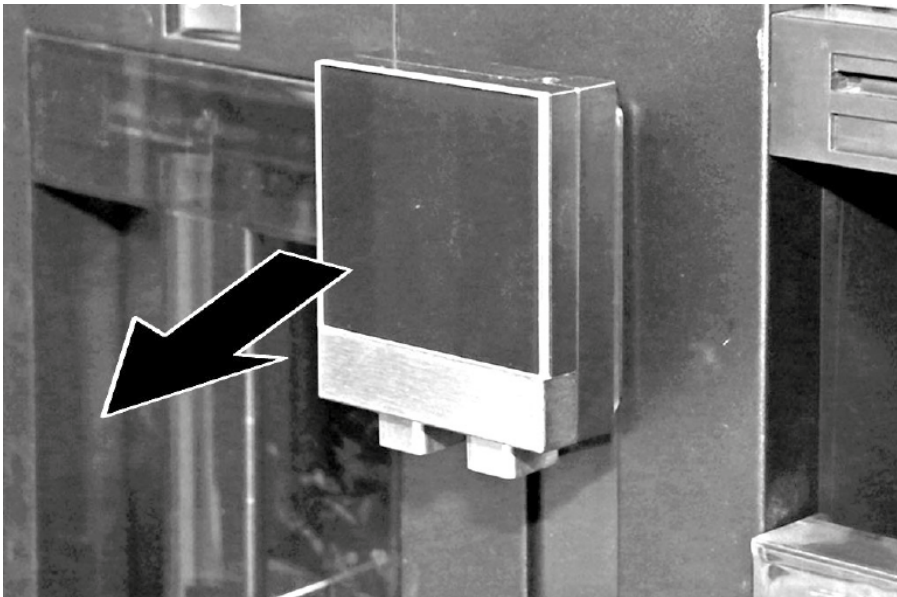

3. Vytáhněte a odeberte dávkovač výpusti nápoje.

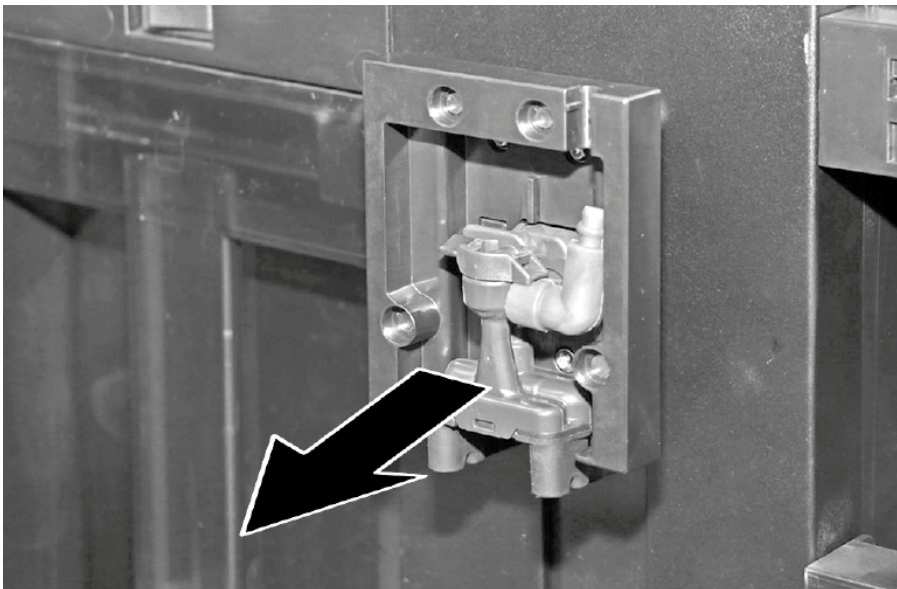

4. Na podpůrném rámu výpusti vyšroubujte čtyři šrouby.

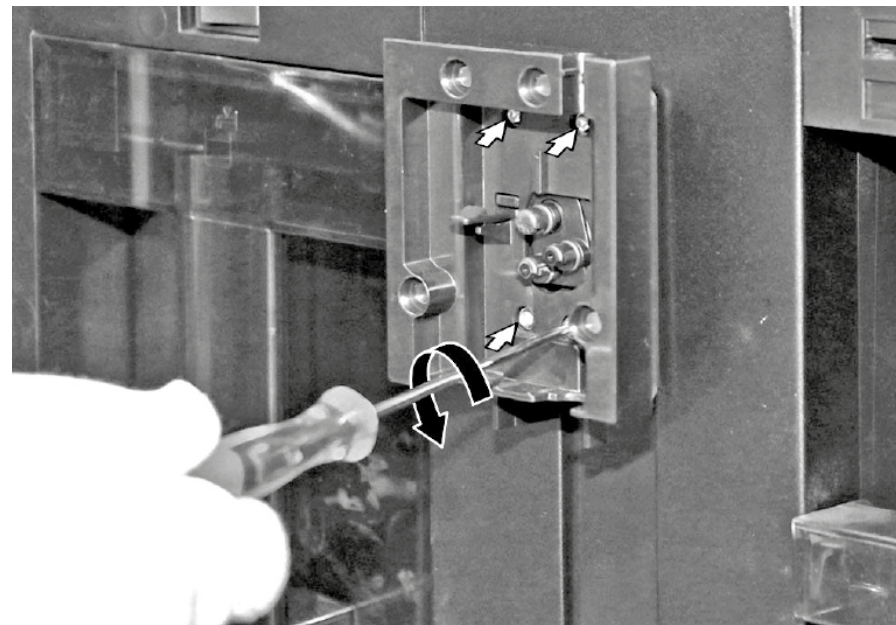

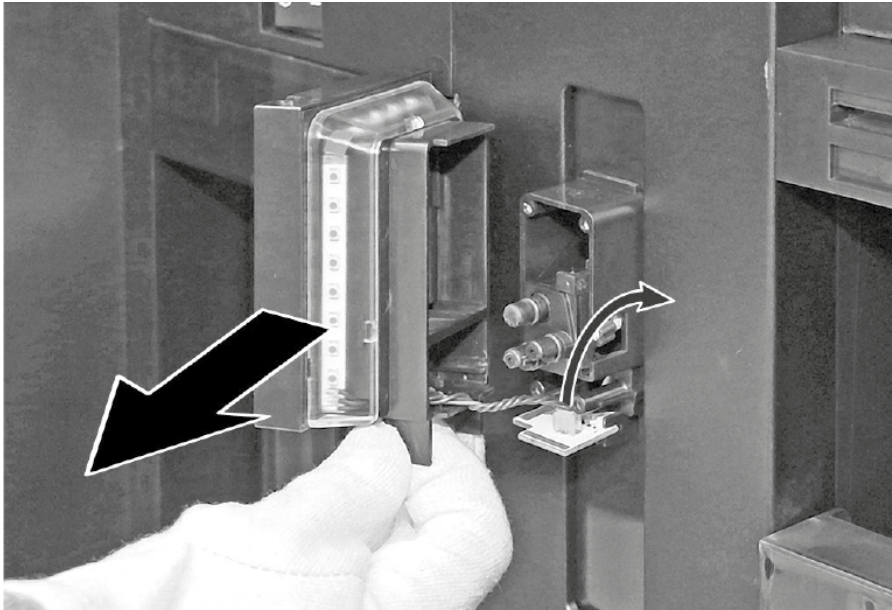

5. Vytáhněte podpůrný rám výpusti, odpojte elektrický konektor a odeberte podpůrný rám výpusti.



- ➡ Zadní kryt podpůrného rámu výpusti nápoje s osvětlením šálek a reflektorovým osvětlením je odebrán.

Tip til reparation - Fulldautomatisk kaffemaskine

 Om dette dokument	27
1.1 Vigtig information.....	27
1.1.1 Formål.....	27
1.2 Forklaring af symboler	27
1.2.1 Fareniveauer	27
1.2.2 Faresymboler.....	27
1.2.3 Advarslernes opbygning	28
1.2.4 Generelle symboler	28
 Sikkerhed	29
2.1 Generelle sikkerhedsanvisninger	29
2.1.1 Alle husholdningsapparater	29
 Værktøjer og hjælpemidler	30
 Reparation	31
4.1 Fjernelse af bagafdækningen til drikudløbets bæreramme med koplys og drikudløbsbelysning.....	31

i Om dette dokument

1.1 Vigtig information

1.1.1 Formål

Disse reparationsanvisninger hjælper kunden til selv at kunne reparere apparater i henhold til den gældende lovgivning om miljøvenligt design (fra 03/2021).





De indeholder information om, hvordan der udskiftes bestemte reservedele, herunder advarsler og risici.

Kontakt kundeservice i tilfælde af spørgsmål. Vi påtager os kun ansvar for skader, hvis reparationsanvisningerne er fuldt korrekt.

1.2 Forklaring af symboler

1.2.1 Fareniveauer

Advarselsniveauerne består af et symbol og et signalford. Signalfordene indikerer farens alvor.





Advarselsniveau	Betydning
	Manglende overholdelse af advarselsmeddelelsen vil medføre død eller alvorlige kvæstelser.
	Manglende overholdelse af advarselsmeddelelsen kan medføre død eller alvorlige kvæstelser.
	Manglende overholdelse af advarselsmeddelelsen kan medføre mindre kvæstelser.
	Manglende overholdelse af advarselsmeddelelsen kan medføre materiel beskadigelse.

Tabel 1: Fareniveauer





1.2.2 Faresymboler

Faresymboler er symbolske visninger, der giver en indikation af faretypen.

Der anvendes følgende faresymboler i dette dokument:

Faresymbol	Betydning
	Generel advarselsmeddelelse
	Fare for elektrisk spænding
	Eksplussionsfare
	Fare for at skære sig

i Om dette dokument

Faresymbol	Betydning
	Fare for klemning
	Fare pga. varme overflader
	Fare pga. kraftigt magnetfelt
	Fare pga. ikke-ioniserende stråling

Tabel 2: Faresymboler

1.2.3 Advarslernes opbygning

Advarsler i dette dokument har et standardiseret udseende og en standardiseret opbygning.











	<p>FARE</p> <p>Farens type og kilde! Mulige følger, hvis faren/advarslen ignoreres.</p> <ul style="list-style-type: none"> ▶ Foranstaltninger og forbud for at forhindre faren.
----------------------------------------------------------------------------------	-----------------------------------------------------------------------------------------------------------------------------------------------------------------------------------------------------------------------------

De følgende eksempler viser en advarsel, der advarer mod elektrisk stød pga. spændingsførende dele. Foranstaltningen til at undgå faren er nævnt.

	<p>FARE</p> <p>Fare for elektrisk stød pga. spændingsførende dele! Død ved elektrisk stød</p> <ul style="list-style-type: none"> ▶ Afbryd apparater fra strømforsyningen i mindst 60 sekunder, før reparationer påbegyndes.
------------------------------------------------------------------------------------	-------------------------------------------------------------------------------------------------------------------------------------------------------------------------------------------------------------------------------------------------------------------------

1.2.4 Generelle symboler

Der anvendes følgende generelle symboler i dette dokument:

Generelt symbol	Betydning
	Angivelse af et særligt tip (tekst og/eller grafik)
	Angivelse af et simpelt tip (kun tekst)
	Angivelse af et link til en videotutorial
	Angivelse af nødvendige værktøjer
	Angivelse af krævede forudsætninger
	Angivelse af en betingelse (hvis..., så...)
	Angivelse af et resultat
	Angivelse af en tast eller knap
	Angivelse af et materialenummer
	Angivelse af en vist tekst/et vist vindue (i apparatets display)

Tabel 3: Generelle symboler

2.1 Generelle sikkerhedsanvisninger

2.1.1 Alle husholdningsapparater

Fare for elektrisk stød pga. spændingsførende dele!

- Fejl i forbindelse med reparationer, der involverer elektriske komponenter, kan medføre elektrisk stød!
- Afbryd apparatet fra strømnettet i mindst 60 sekunder, før arbejdet påbegyndes.
- Få efter reparationen udført en sikkerhedstest i henhold til VDE 0701 eller landespecifikke forskrifter.

Fare for tilskadekomst pga. skarpe kanter!

- Brug beskyttelseshandsker.

Fare for klemning i forbindelse med reparation, vedligeholdelse, fejlafhjælpning og service på grund af tunge og bevægelige komponenter

- Brug sikkerhedssko.
- Sørg for at sikre tunge komponenter mod at falde ned.
- Stik kropsdele ind i bevægelige komponenter.

Fare for apparatets sikkerhed/funktion!

- Brug kun originale reservedele.

Fare for beskadigelse af elektrostatisk følsomme komponenter (elektrostatiske afladninger)!

- Berør ikke modulerne, herunder forbindelser og ledningsbaner.

Værktøjer og hjælpemidler

Betegnelse	Detaljer	Billeder
Torx-bit TX10 [00340864]	6,3 mm (1/4")	

4.1 Fjernelse af bagafdækningen til drikudløbets bæreramme med kopllys og drikudløbsbelysning

Nødvendig værktøj:

🔧 Torx-bit TX10 6,3 mm (1/4") [00340864]

 Dit apparat er udstyret med en vedligeholdelsesfri LED-lampe. Denne lampe må kun repareres af kundeservice eller autoriserede teknikere!

 **FARE**
Fare for elektrisk stød pga. spændingsførende dele!
Livsfare pga. elektrisk stød i tilfælde af ukorrekt reparation

- ▶ Elektriske dele skal repareres af kvalificerede elektrikere.
- ▶ Få efter reparationen udført en sikkerhedstest i henhold til VDE 0701 eller landespecifikke forskrifter.

 **FARE**
Fare for elektrisk stød pga. spændingsførende dele!
Død ved elektrisk stød

- ▶ Afbryd apparatet fra strømforsyningen i mindst 60 sekunder, før reparationer påbegyndes.

 **PAS PÅ!**
Skarpe kanter!
Snitlæsioner

- ▶ Brug beskyttelseshandsker.

 **BEMÆRK!**
Fare for beskadigelse af elektrostatisk følsomme komponenter (ESD'er)!
Komponentbeskadigelse

- ▶ Anvend et elektrostatisk beskyttelsessystem (ESD-armbånd), inden ESD'erne berøres.
- ▶ Berør ikke modulernes forbindelser og ledningsbaner.
- ▶ Transportér kun ESD'er i ledende materialer eller original emballage.
- ▶ Hold ESD'er væk fra materialer (f.eks. plastik), der kan oplades elektrostatisk.

Preindstilling:

- ✓ Apparatet er afbrudt fra strømforsyningen.
1. Åbn apparatets frontdør.

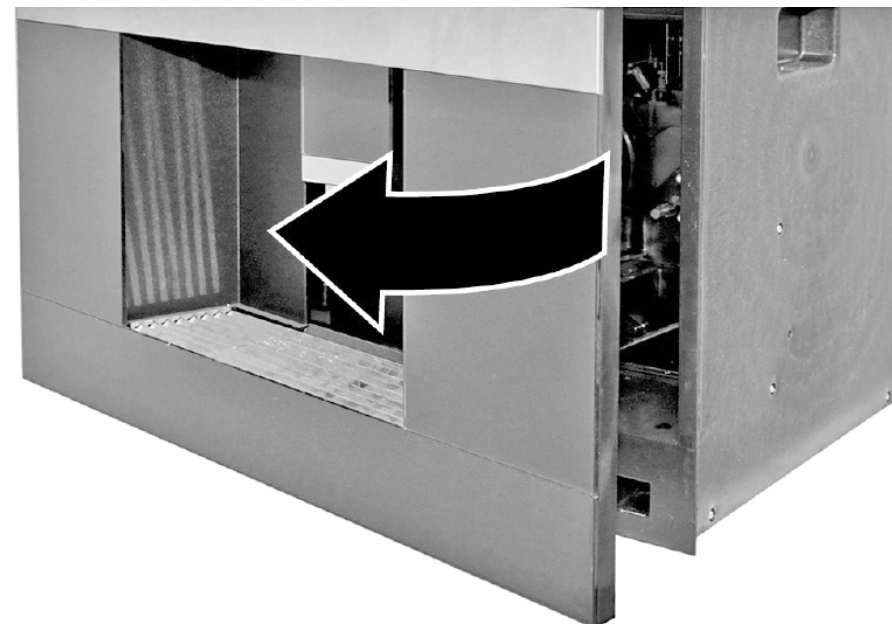

Reparation

2. Træk drikudløbsafdækningen af, og fjern den.

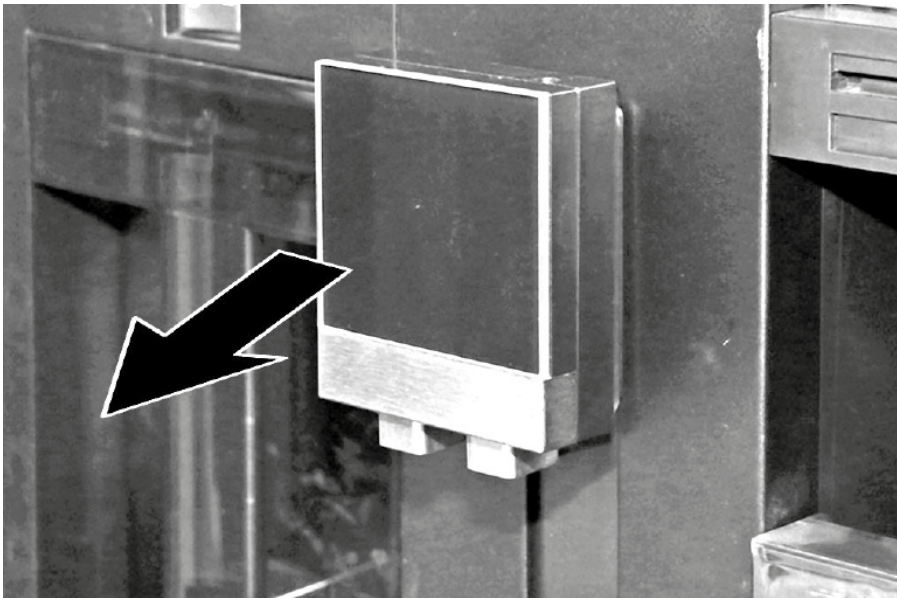

3. Træk drikudløbsdispenseren ud, og fjern den.

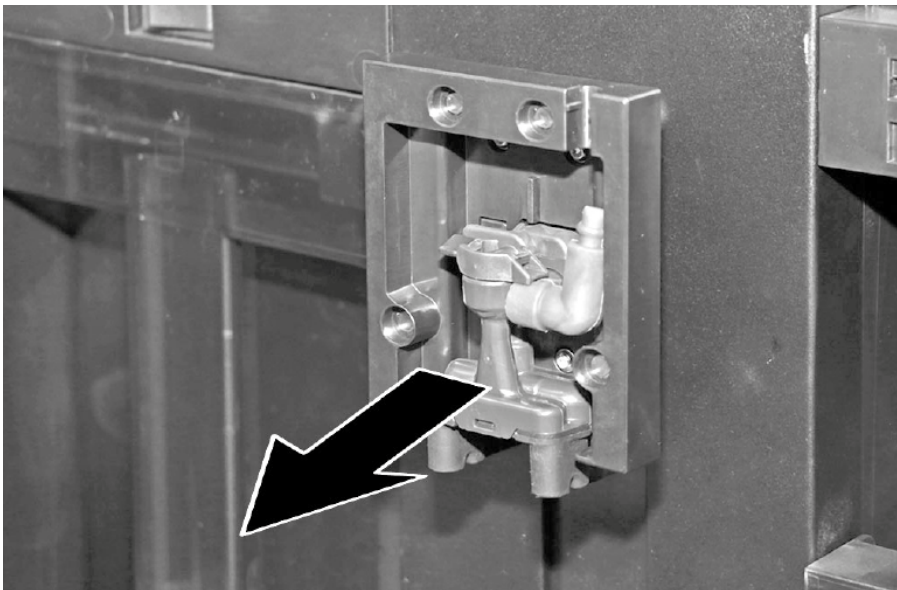

4. Skru de fire skruer ud på udløbets bæreramme.

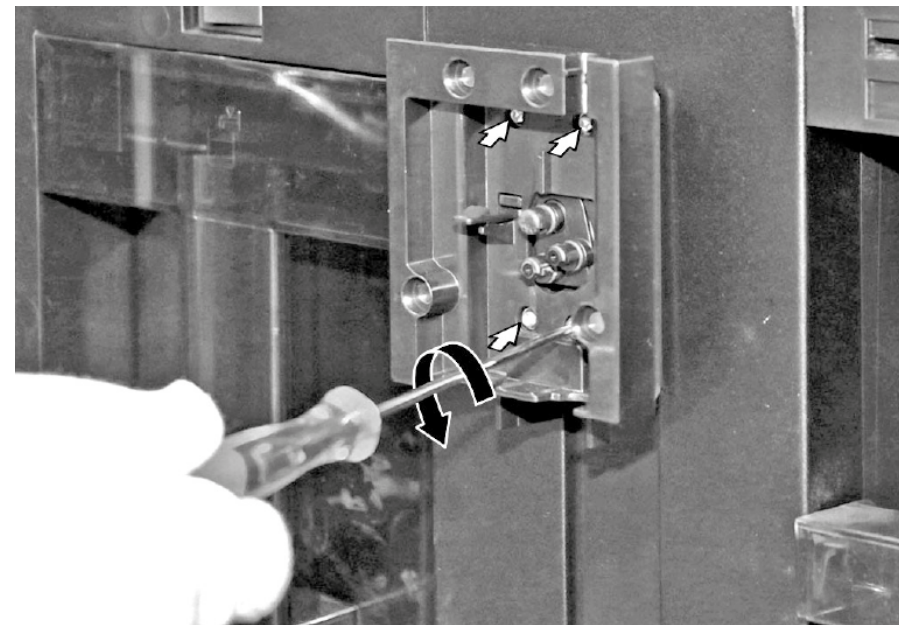

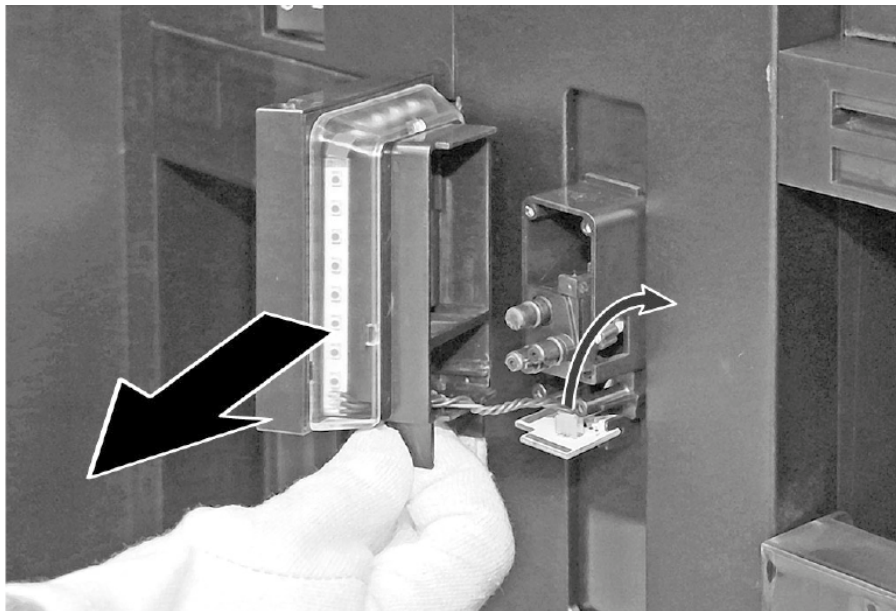

Reparation

5. Træk udløbets bæreramme af, afbryd den elektriske konektor, og fjern udløbets bæreramme.



6. Bagafdækningen til drikudløbets bæreramme med koplys og driksudløbsbelysning er fjernet.

Reparatie informatie - Volautomatische espressomachine

 Over dit document	35
1.1 Belangrijke informatie	35
1.1.1 Doel	35
1.2 Verklaring van symbolen	35
1.2.1 Gevarenniveaus	35
1.2.2 Gevarensymbolen	35
1.2.3 Structuur van de waarschuwingen	36
1.2.4 Algemene symbolen	36
 Veiligheid	37
2.1 Algemene veiligheidsinstructies	37
2.1.1 Alle huishoudelijke apparaten	37
 Gereedschappen en hulpmiddelen	38
 Reparatie	39
4.1 Het achterpaneel van het frame van de drankuitloop met kopjesverlichting en spotverlichting verwijderen	39

i Over dit document

1.1 Belangrijke informatie

1.1.1 Doel

Met deze reparatieaanwijzingen wordt de klant geholpen zelf apparaten te repareren conform de toepasselijke verordening inzake ecologisch ontwerp (met ingang van 03/2021).



Ze bevatten informatie over hoe gedefinieerde reserveonderdelen kunnen worden vervangen met inbegrip van waarschuwingen en gevaren.

Neem bij vragen contact op met onze klantenservice. We stellen ons alleen aansprakelijk voor schade als de reparatieaanwijzingen correct zijn opgevolgd.

1.2 Verklaring van symbolen

1.2.1 Gevarenniveaus

De waarschuwningsniveaus worden aangegeven met een symbool en een signaalwoord. Het signaalwoord geeft de ernst van het gevaar aan.



Waarschuwningsniveau	Betekenis
	Als de waarschuwing niet in acht wordt genomen, leidt dat tot ernstig of dodelijk letsel.
	Als de waarschuwing niet in acht wordt genomen, kan dat tot ernstig of dodelijk letsel leiden.
	Als de waarschuwing niet in acht wordt genomen, kan dat tot licht letsel leiden.
	Als de waarschuwing niet in acht wordt genomen, kan dat tot materiële schade leiden.

Tabel 1: Gevarenniveaus

1.2.2 Gevarensymbolen

Gevarensymbolen zijn symbolische afbeeldingen die een indicatie geven van het soort gevaar.

De volgende gevarensymbolen worden in dit document gebruikt:

Gevarensymbool	Betekenis
	Algemene waarschuwing
	Gevaar voor elektrische spanning
	Ontploffingsgevaar
	Snijgevaar

i Over dit document

Gevarensymbool	Betekenis
	Beknellingsgevaar
	Gevaar voor hete oppervlakken
	Gevaar voor sterke magnetische velden
	Gevaar voor niet-ioniserende straling

Tabel 2: Gevarensymbolen

1.2.3 Structuur van de waarschuwingen

Waarschuwingen in dit document hebben een gestandaardiseerd uiterlijk en een gestandaardiseerde structuur.







	<div style="background-color: red; color: white; padding: 2px; text-align: center;">⚠ GEVAAR</div> <p>Soort gevaar en bron van het gevaar! Mogelijke gevolgen van het negeren van het gevaar / de waarschuwing.</p> <ul style="list-style-type: none"> ▶ Maatregelen en verboden om het gevaar te voorkomen.
----------------------------------------------------------------------------------	-----------------------------------------------------------------------------------------------------------------------------------------------------------------------------------------------------------------------------------------------------------------------------------------------------------------------------------------------

In het volgende voorbeeld is een waarschuwing te zien waarmee voor een elektrische schok aan stroomvoerende onderdelen wordt gewaarschuwd. De maatregel om het gevaar te vermijden wordt vermeld.

	<div style="background-color: red; color: white; padding: 2px; text-align: center;">⚠ GEVAAR</div> <p>Gevaar voor een elektrische schok aan stroomvoerende onderdelen! Dood door elektrocutie</p> <ul style="list-style-type: none"> ▶ Haal apparaten minstens 60 seconden voor u met reparaties begint van de stroomvoorziening af.
------------------------------------------------------------------------------------	-----------------------------------------------------------------------------------------------------------------------------------------------------------------------------------------------------------------------------------------------------------------------------------------------------------------------------------------------------------------------

1.2.4 Algemene symbolen

De volgende algemene symbolen worden in dit document gebruikt:

Alg. symbool	Betekenis
	Identificatie van een speciale tip (tekst en/of afbeelding)
	Identificatie van een eenvoudige tip (tekst)
	Identificatie van een link naar een video-instructie
	Identificatie van vereiste gereedschappen
	Identificatie van vereiste voorwaarden
	Identificatie van een voorwaarde (als ..., dan ...)
	Identificatie van een resultaat
[Start]	Identificatie van een toets of knop
[00123456]	Identificatie van een materiaalnummer
Status	Identificatie van weergegeven tekst / venster (in het display van het apparaat)

Tabel 3: Algemene symbolen

2.1 Algemene veiligheidsinstructies

2.1.1 Alle huishoudelijke apparaten

Gevaar voor een elektrische schok aan stroomvoerende onderdelen!

- Fouten bij reparaties aan elektrische componenten kunnen tot een elektrische schok leiden!
- Koppel het apparaat minstens 60 seconden los van het stroomnet voordat u met de werkzaamheden begint.
- Laat na de reparatie een veiligheidstest conform VDE 0701 of de landspecifieke regelgeving uitvoeren.

Gevaar voor letsel aan scherpe randen!

- Draag veiligheidshandschoenen.

Beknellingsgevaar tijdens reparatie, onderhoud, probleemoplossing en service vanwege zware en bewegende componenten

- Draag veiligheidsschoenen.
- Beveilig zware componenten tegen vallen.
- Steek geen lichaamsdelen in bewegende componenten.

Gevaar voor de veiligheid / werking van het apparaat!

- Gebruik uitsluitend originele reserveonderdelen.

Gevaar voor schade aan elektrostatisch gevoelige componenten (ESD's)!

- Raak de modules met inbegrip van de aansluitingen en geleiderbanen niet aan.

Gereedschappen en hulpmiddelen

Benaming	Details	Afbeeldingen
Torx-Bit TX10 [00340864]	6,3 mm (1/4")	

4.1 Het achterpaneel van het frame van de drankuitloop met kopjesverlichting en spotverlichting verwijderen

Speciale hulpmiddelen:

Torx-Bit TX10 6,3 mm (1/4") [00340864]

 Uw apparaat heeft een onderhoudsvrije LED-lamp. Deze lampen mogen uitsluitend door de klantenservice of geautoriseerde monteurs worden vervangen!

 **GEVAAR**
Gevaar voor een elektrische schok aan stroomvoerende onderdelen!
 Levensgevaar door elektrische schokken in geval van een ondeskundige reparatie

- ▶ Elektrische onderdelen moeten door gekwalificeerde elektriciens worden gerepareerd.
- ▶ Laat na de reparatie een veiligheidstest conform VDE 0701 of de landspecifieke regelgeving uitvoeren.

 **GEVAAR**
Gevaar voor een elektrische schok aan stroomvoerende onderdelen!
 Dood door elektrocutie

- ▶ Haal apparaten minstens 60 seconden voor u met reparaties begint van de stroomvoorziening af.

 **VOORZICHTIG**
Scherpe randen!
 Snijletsel

- ▶ Draag veiligheidshandschoenen.

 **LET OP!**
Gevaar voor schade aan electrostatisch gevoelige componenten (ESD's)!
 Schade aan componenten

- ▶ Gebruik een electrostatisch beschermingsmiddel (aardingspoliband) voordat u ESD's aanraakt.
- ▶ Raak geen aansluitingen en geleiderbanen van de modules aan.
- ▶ Vervoer ESD's uitsluitend in geleidende materialen of in de oorspronkelijke verpakking.
- ▶ Houd ESD's uit de buurt van mogelijk electrostatische materialen (zoals kunststof).

Voorwaarde:

 Apparaat wordt van de stroomvoorziening afgehaald.

1. Open de deur aan de voorzijde van het apparaat.

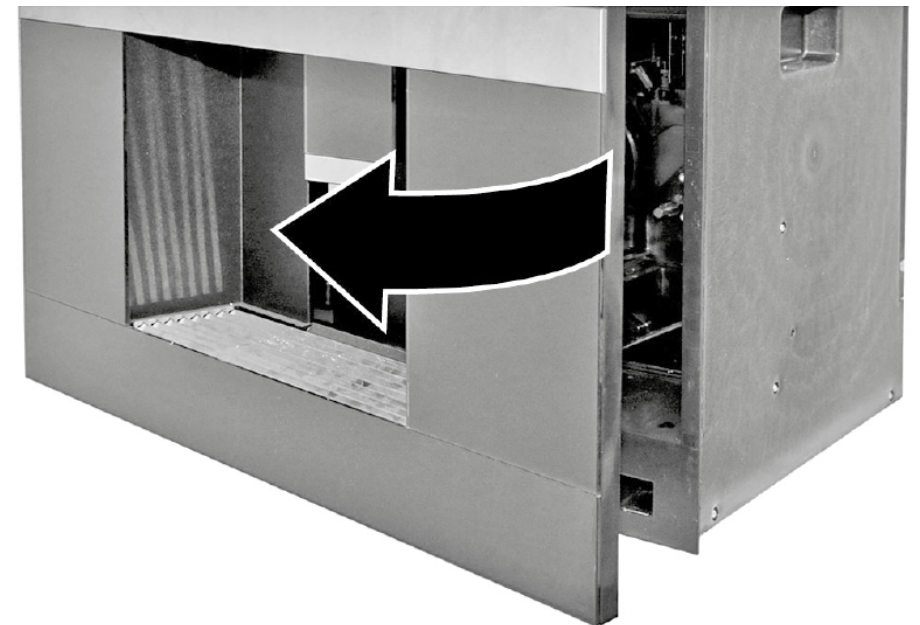

Reparatie

2. Trek het paneel van de drankuitloop eraf.

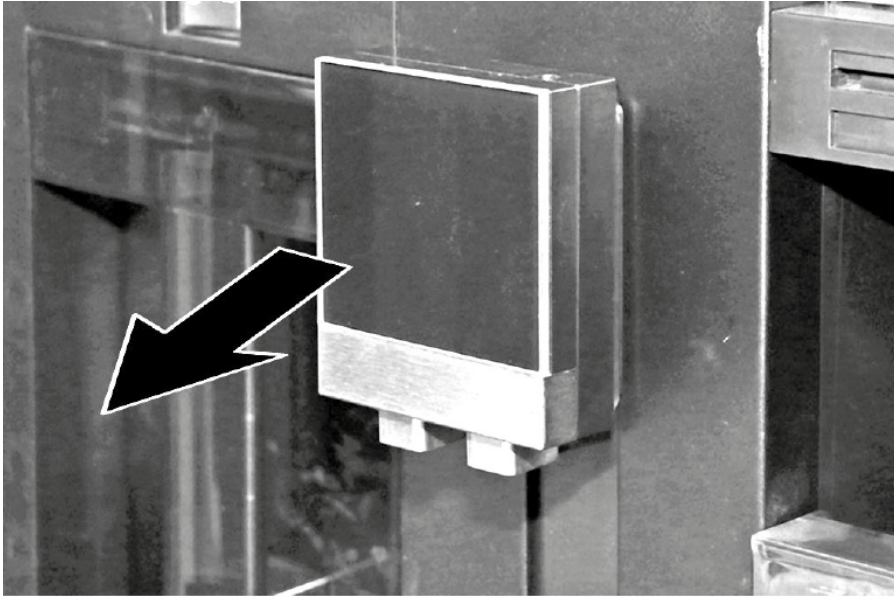

3. Trek de dispenser van de drankuitloop eruit.

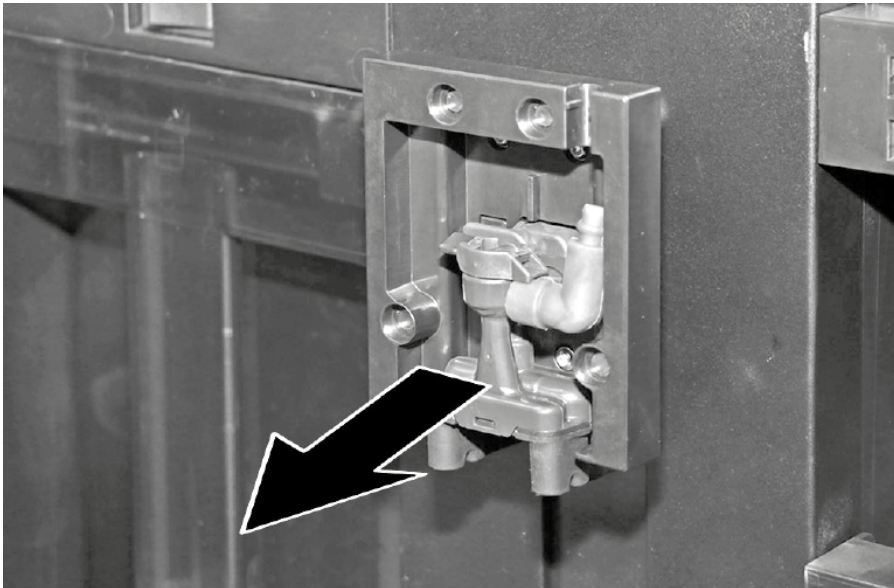

4. Draai de vier schroeven op het frame van de uitloop los.

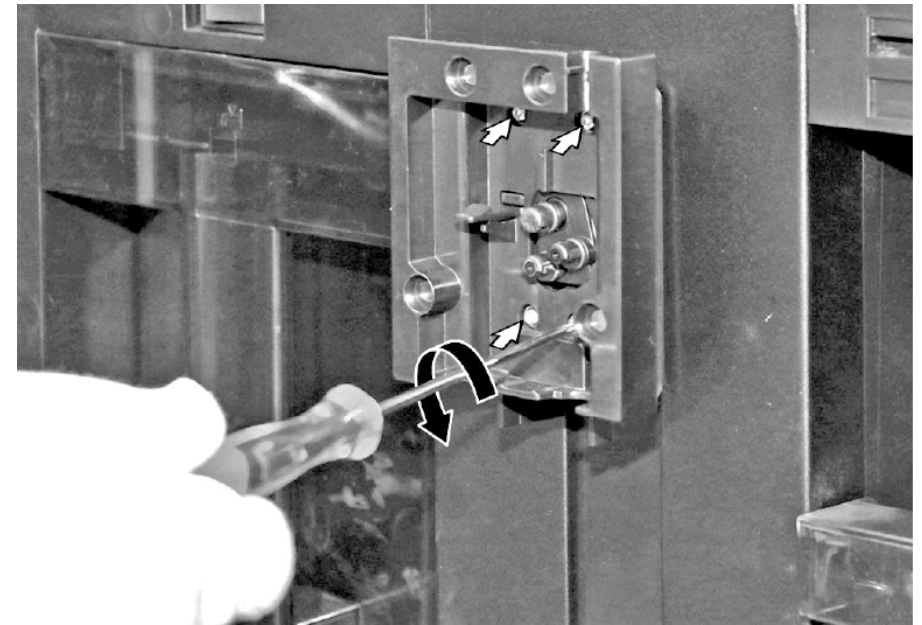



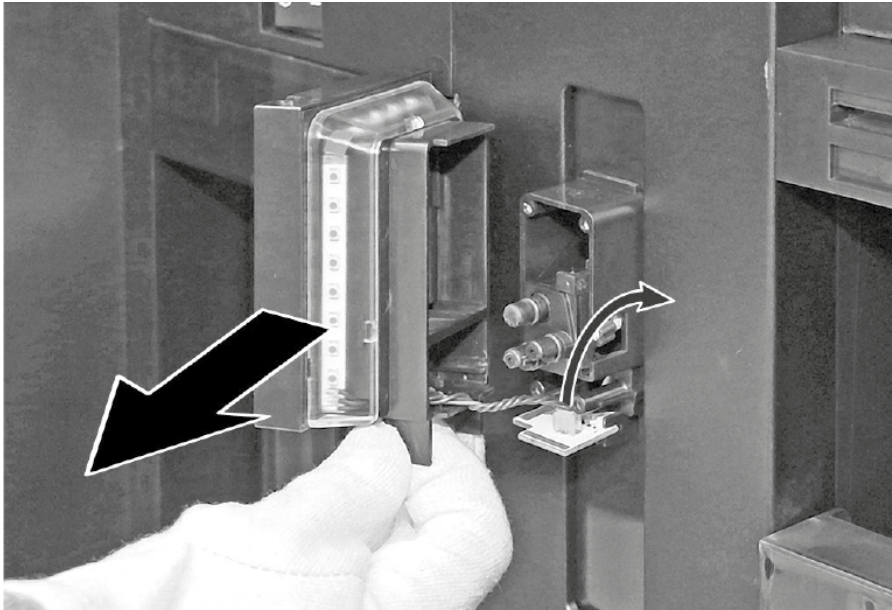

Reparatie

5. Trek het frame van de uitloop eraf, ontkoppel de elektrische aansluiting en verwijder het frame van de uitloop.



- ➡ Het achterpaneel van het frame van de drankuitloop met kopjesverlichting en spotverlichting is verwijderd.

Self-repair hints - Fully automatic espresso machine

 Concerning this document	43
1.1 Important information	43
1.1.1 Purpose.....	43
1.2 Explanation of symbols	43
1.2.1 Danger levels.....	43
1.2.2 Hazard symbols	43
1.2.3 Structure of the warnings.....	44
1.2.4 General symbols.....	44
 Safety	45
2.1 General Safety instructions	45
2.1.1 All domestic appliances	45
 Tools and aids	46
 Repair	47
4.1 Removing beverage outlet support frame back cover with cup light and stage lighting.....	47

i Concerning this document

1.1 Important information

1.1.1 Purpose

These repair hints support consumer to repair appliances by himself according to the applicable eco-design regulation (as of 03/2021).

They contain information how to exchange defined spare parts including warnings and risks.

In case of questions, please contact our customer service. We will only be liable for damages if the repair hints have been followed properly.

1.2 Explanation of symbols

1.2.1 Danger levels

The warning levels consist of a symbol and a signal word. The signal word indicates the severity of the danger.









Warning level	Meaning
 Danger	Non-observance of the warning message will result in death or serious injuries.
 Warning	Non-observance of the warning message could result in death or serious injuries.
 Caution	Non-observance of the warning message could result in minor injuries.
 Notice	Non-observance of the warning message could result in damage to property.

Table 1: Danger levels

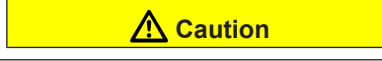
1.2.2 Hazard symbols

Hazard symbols are symbolic representations which give an indication of the kind of danger.

The following hazard symbols are used in this document:

Hazard symbol	Meaning
	General warning message
	Danger from electrical voltage
	Risk of explosion
	Danger of cuts
	Danger of crushing

i Concerning this document



Hazard symbol	Meaning
	Danger from hot surfaces
	Danger from strong magnetic field
	Danger from non-ionizing radiation

Table 2: Hazard symbols

1.2.3 Structure of the warnings

Warnings in this document have a standardised appearance and a standardised structure.



	<div style="background-color: red; color: white; padding: 2px; text-align: center;">⚠ Danger</div> <p>Type and source of danger! Possible consequences of ignoring the danger / warning.</p> <ul style="list-style-type: none"> ▶ Measures and prohibitions for preventing the danger.
----------------------------------------------------------------------------------	-------------------------------------------------------------------------------------------------------------------------------------------------------------------------------------------------------------------------------------------------------------------------------------------------------------------------

The following example shows a warning that warns against electric shock due to live parts. The measure for avoiding the danger is mentioned.

	<div style="background-color: red; color: white; padding: 2px; text-align: center;">⚠ Danger</div> <p>Risk of electric shock due to live parts! Death by electrocution</p> <ul style="list-style-type: none"> ▶ Disconnect appliances from electrical supply at least 60 seconds before starting repairs.
-----------------------------------------------------------------------------------	--------------------------------------------------------------------------------------------------------------------------------------------------------------------------------------------------------------------------------------------------------------------------------------------------------------------------------------------

1.2.4 General symbols

The following general symbols are used in this document:

Gen. symbol	Meaning
	Identification of a special tip (text and/or graphic)
	Identification of a simple tip (only text)
	Identification of a link to a video tutorial





Gen. symbol	Meaning
	Identification of required tools
	Identification of required preconditions
	Identification of a condition (if ..., then ...)
	Identification of a result
[Start]	Identification of a key or button
[00123456]	Identification of a material number
Status	Identification of displayed text / window (in the appliance's display)

Table 3: General symbols

2.1 General Safety instructions

2.1.1 All domestic appliances

Risk of electric shock due to live parts!

- Errors by repairs involving electrical components can lead to electrical shock!
- Disconnect the appliance from the mains for at least 60 seconds before starting work.
- After the repair have a safety test according VDE 0701 or country-specific regulations performed.

Risk of injury from sharp edges!

- Wear protective gloves.

Risk of crushing during repair, maintenance, troubleshooting and service due to heavy and moving components

- Wear protective shoes.
- Secure heavy components from falling down.
- Do not stick body parts into moving components.

Risk to the appliance's safety / function!

- Only use original spare parts.

Risk of damage to electrostatically sensitive components (ESDs)!

- Do not touch the modules, including connections and conductor paths.

Tools and aids

Designation	Details	Images
Torx-Bit TX10 [00340864]	6,3 mm (1/4")	

4.1 Removing beverage outlet support frame back cover with cup light and stage lighting

Required tools:

 Torx-Bit TX10 6,3 mm (1/4") [00340864]

 Your appliance features a maintenance-free LED light. These lights may be repaired by customer service or authorised technicians only!

 **Danger**
Risk of electric shock due to live parts!
 Danger to life through electric shock in case of improper repair

- ▶ Electric parts should be repaired by a qualified electricians.
- ▶ After the repair have a safety test according VDE 0701 or country-specific regulations performed.

 **Danger**
Risk of electric shock due to live parts!
 Death by electrocution

- ▶ Disconnect appliances from electrical supply at least 60 seconds before starting repairs.

 **Caution**
Sharp edges!
 Cut injuries

- ▶ Wear protective gloves.

 **Notice**
Risk of damage to electrostatically sensitive components (ESDs)!
 Components damage

- ▶ Before touching ESDs, use an electrostatic protection system (wristband with earth safe plug).
- ▶ Do not touch connections and conductor paths of the modules.
- ▶ Only transport ESDs in conductive materials or original packaging.
- ▶ Keep ESDs clear of electrostatically chargeable materials (i.e. plastic).

Prerequisite:

 Appliance is disconnected from power supply.

1. Open the appliance's front door.

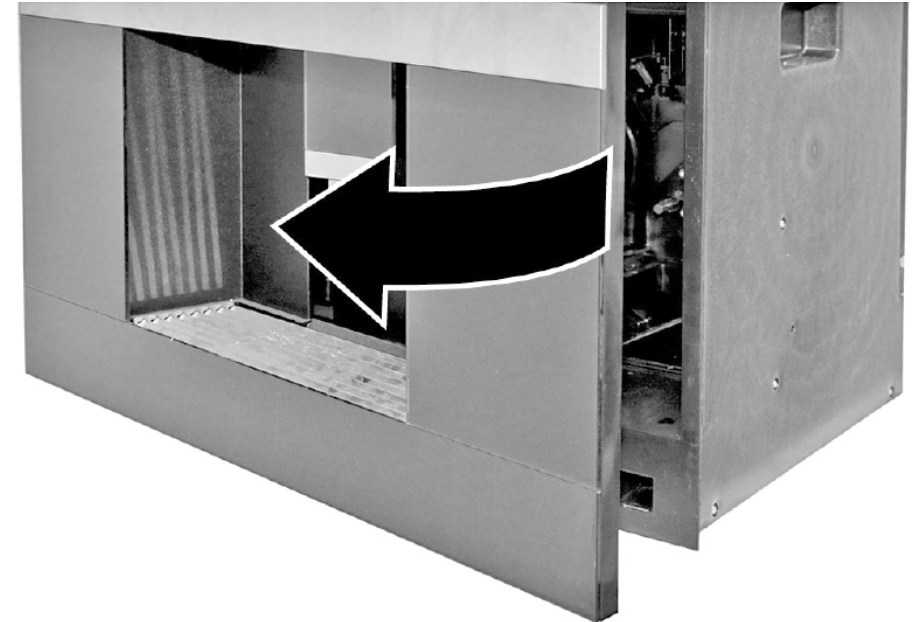

2. Pull off and remove beverage outlet cover.

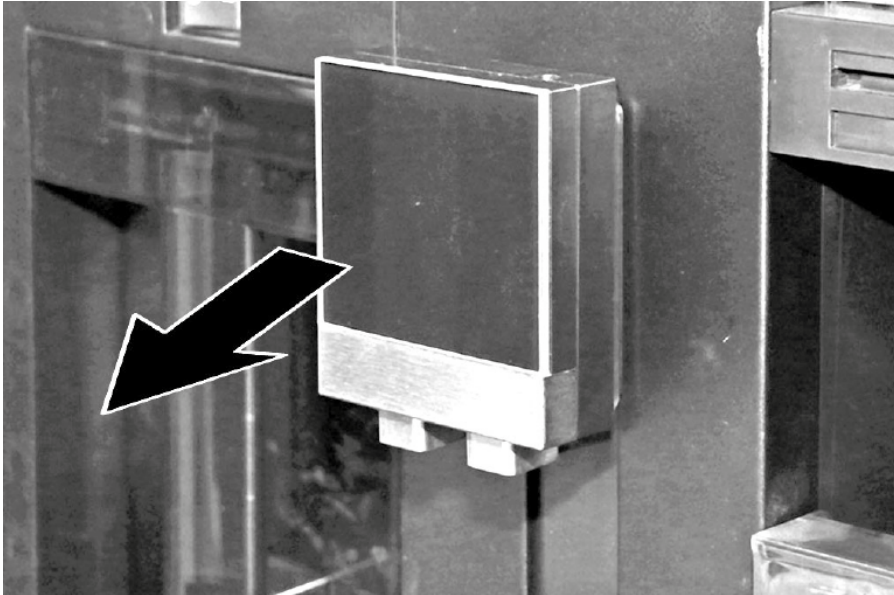

3. Pull out and remove beverage outlet dispenser.

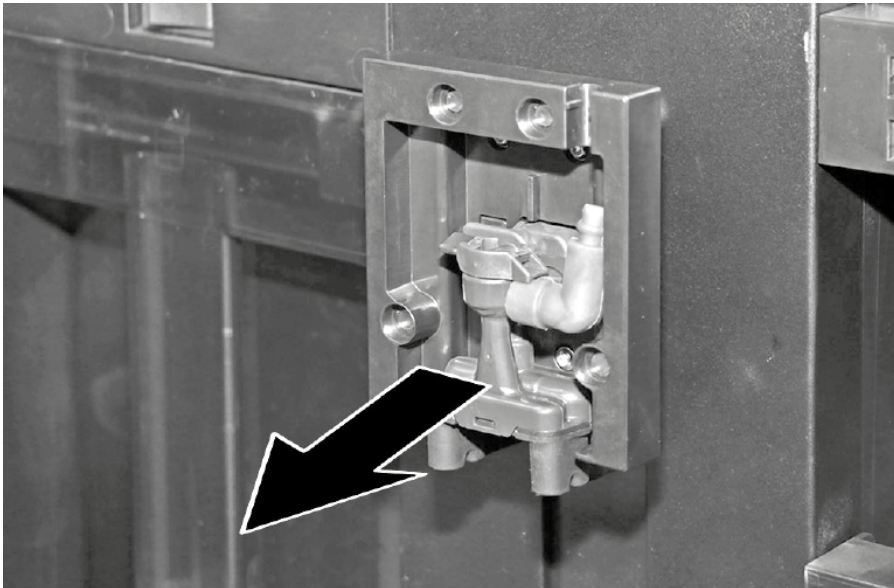

4. Unscrew four screws on outlet support frame.

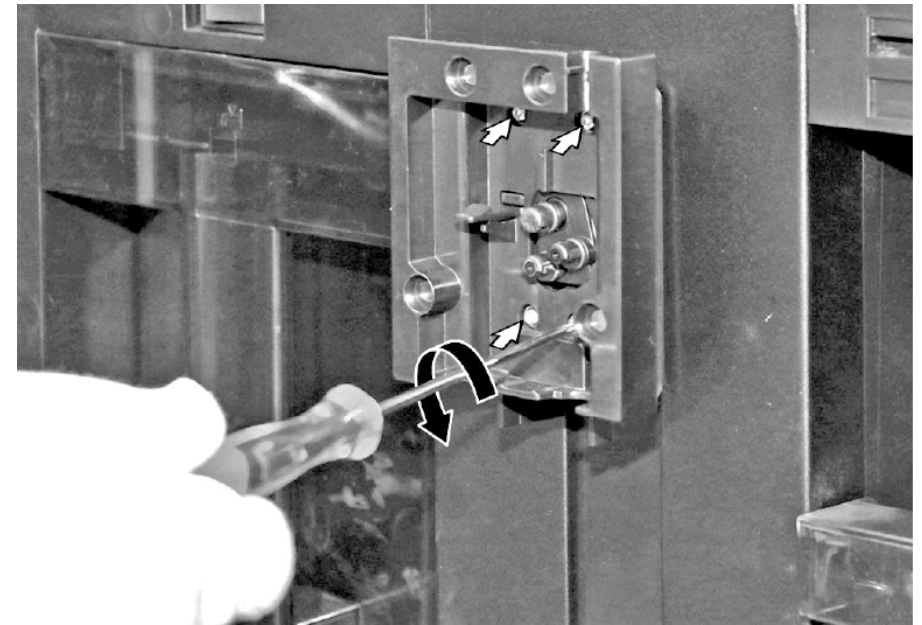



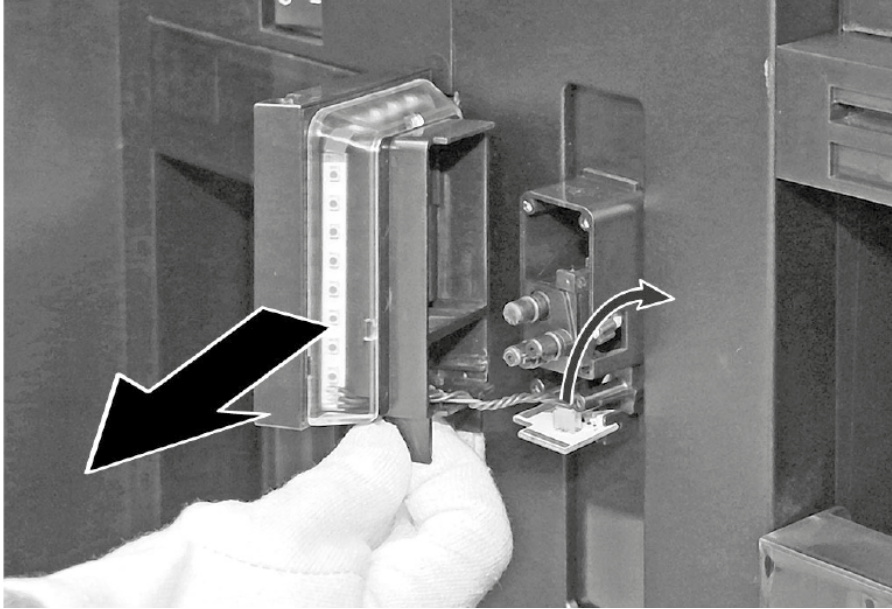

Repair

5. Pull off outlet support frame, disconnect electrical connector and remove outlet support frame.



- ➡ Beverage outlet support frame back cover with cup light and stage lighting is removed.

Remonditeave - Fully automatic espresso machine

 Selle dokumendiga seoses	51
1.1 Tähtis teave	51
1.1.1 Eesmärk.....	51
1.2 Sümbolite selgitus	51
1.2.1 Ohutasemed	51
1.2.2 Ohusümbolid	51
1.2.3 Hoiatuste struktuur	52
1.2.4 Üldised sümbolid.....	52
 Ohutus.....	53
2.1 Üldised ohutusjuhised.....	53
2.1.1 Kõik kodumasinad.....	53
 Tööriistad ja abinõud.....	54
 Remont.....	55
4.1 Jookide väljalaskesüsteemi tugiraami tagumise katte eemaldamine koos topsitule ja joogiava valgustusega	55

i Selle dokumendiga seoses

1.1 Tähtis teave

1.1.1 Eesmärk

Need remondinõuanded toetavad tarbijat seadmete iseseisval remontimisel vastavalt kehtivale ökodisaini määrusele (03/2021).





Need sisaldavad teavet selle kohta, kuidas vahetada teatud varuosi, samuti hoiatusi ning ohtusid.

Küsimuste korral võtke ühendust meie klienditeenindusega. Meie vastutame kahjustuste eest ainult siis, kui remondinõuandeid on õigesti järgitud.

1.2 Sümbolite selgitus

1.2.1 Ohutasemed

Ohutasemed koosnevad sümbolist ja märksõnast. Märksõna viitab ohu raskusastmele.

Hoiatustase	Tähendus
 OHT	Hoiatusteadete eiramine põhjustab surma või raskeid kehavigastusi.
 HOIATUS	Hoiatusteadete eiramine võib põhjustada surma või raskeid kehavigastusi.
 ETTEVAATUST!	Hoiatusteadete eiramine võib põhjustada kergeid kehavigastusi.
 TÄHELEPANU!	Hoiatusteadete eiramine võib põhjustada varakahju.

Tabel 1: Ohutasemed



1.2.2 Ohusümbolid

Ohusümbolid on sümboolsed kujutised, mis viitavad ohu laadile.

Selles dokumendis kasutatakse alljärgnevaid ohusümboleid.

Ohusümbol	Tähendus
	Üldine ohuteade
	Elektripingest tingitud oht
	Plahvatusoht
	Lõikeoht
	Muljumisoht



i Selle dokumendiga seoses

Ohusümbol	Tähendus
	Kuumadest pindadest tingitud oht
	Tugevast magnetväljast tingitud oht
	Mitteioniseerivast kiirgusest tingitud oht

Tabel 2: Ohusümbolid

1.2.3 Hoiatuste struktuur

Selles dokumendis olevatel hoiatustel on standardiseeritud väljanägemine ja standardiseeritud struktuur.



	<div style="background-color: red; color: white; padding: 2px; display: inline-block;"> OHT</div> Ohu tüüp ja allikas! Ohu/hoiatuse eiramise võimalikud tagajärjed. ▶ Meetmed ja ettevaatusabinõud ohu vältimiseks.
----------------------------------------------------------------------------------	-----------------------------------------------------------------------------------------------------------------------------------------------------------------------------------------------------------------------------------------------------------------------------------------------------------------------------





Alljärgnevas näiteks on näidatud hoiatust, millega hoiatatakse liikuvatest osadest tingitud elektrilöögiu eest. Nimetatud on meetet ohu vältimiseks.

	<div style="background-color: red; color: white; padding: 2px; display: inline-block;"> OHT</div> Liikuvatest osadest tingitud elektrilöögi oht! Elektrilöögist tingitud surm ▶ Enne remonditöödega alustamist ühendage seadmed elektrivõrgust lahti vähemalt 60 sekundit varem.
-----------------------------------------------------------------------------------	-------------------------------------------------------------------------------------------------------------------------------------------------------------------------------------------------------------------------------------------------------------------------------------------------------------------------------------------------------------------------------------------

1.2.4 Üldised sümbolid

Selles dokumendis kasutatakse alljärgnevaid üldisi sümboleid.

Üld. sümbol	Tähendus
	Erinõuande tunnus (tekst ja/või graafik)
	Lihtsa nõuande tunnus (ainult tekst)
	Videojuhendi lingi tunnus

Üld. sümbol	Tähendus
	Vajalike tööriistade tunnus
	Vajalike eeltingimuste tunnus
	Seisukorra tunnus (kui..., siis...)
	Tulemuse tunnus
[Start]	Klahvi või nupu tunnus
[00123456]	Materjalinumbriga tunnus
Olek	Kuvatava teksti/akna tunnus (seadme ekraanil)

Tabel 3: Üldised sümbolid

2.1 Üldised ohutusjuhised

2.1.1 Kõik kodumasinad

Liikuvatest osadest tingitud elektrilöögi oht!

- Elektriliste osade remondil tehtud vead võivad põhjustada elektrilööki!
- Lahutage seade vooluvõrgust vähemalt 60 sekundit enne tööle hakkamist.
- Pärast remonti peab olema tehtud ohutuskatse vastavalt standardile VDE 0701 või riiklikele määrustele.

Teravatest servadest tingitud vigastusoht!

- Kandke kaitsekindaid.

Rasketest ja liikuvatest osadest tingitud muljumisoht remondi-, puhastustööde, tõrkeotsingu ja hoolduse käigus

- Kandke turvakingi.
- Kinnitage rasked osad allakukkumise vastu.
- Ärge toppige kehaosi liikuvate osade vahele.

Oht seadme ohutusele/talitlusele!

- Kasutage ainult originaalvaruosasid.

Elektrostaatiliselt tundlike osade (ESD) kahjustamise oht!

- Ärge puudutage moduleid, kaasa arvatud ühendusi ega transportöörlinte.

Tööriistad ja abinõud

Määramine	Üksikasjad	Kujutised
Tähtotsik TX10 [00340864]	6,3 mm (1/4 tolli)	

4.1 Jookide väljalaskesüsteemi tugiraami tagumise katte eemaldamine koos topsitule ja joogiava valgustusega

Eritööriistad:

Tähtotsik TX10 6,3 mm (1/4 tolli) [00340864]



Teie seadmel on LED-tuli, mis ei vaja hooldust.
Seda tuld tohib parandada ainult klienditeenindus või volitatud tehnik!



OHT

Liikuvatest osadest tingitud elektrilöögi oht!

Kui remonditööd on valesti tehtud, esineb elektrilöögist tingitud eluohu.

- ▶ Elektrilisi osadid peavad parandama kvalifitseeritud elektrikud.
- ▶ Pärast remonti peab olema tehtud ohutuskatse vastavalt standardile VDE 0701 või riiklikele määrustele.



OHT

Liikuvatest osadest tingitud elektrilöögi oht!

Elektrilöögist tingitud surm

- ▶ Enne remonditöödega alustamist ühendage seadmed elektrivõrgust lahti vähemalt 60 sekundit varem.



ETTEVAATUST!

Teravad servad!

Lõikehaavad

- ▶ Kandke kaitsekindaid.



TÄHELEPANU!

Elektrostaatiliselt tundlike osade (ESD) kahjustamise oht!

Osade kahjustamine

- ▶ Enne ESD-de puudutamist veenduge, et kasutaksite antistaatilisest kaitsestüsteemi (maandusega ühendatava pistikuga käepael).
- ▶ Ärge puudutage moodulite ühendusi ega juhtivaid kontuure.
- ▶ Transportige ESD-sid ainult juhtivate materjalide sees või originaalpakendis.
- ▶ Hoidke ESD-d elektrostaatiliselt laetavatest materjalidest (nt plast) eemal.

Nõue:

- ✔ Seade on toitest lahutatud.

1. Avage seadme eesmine uks.

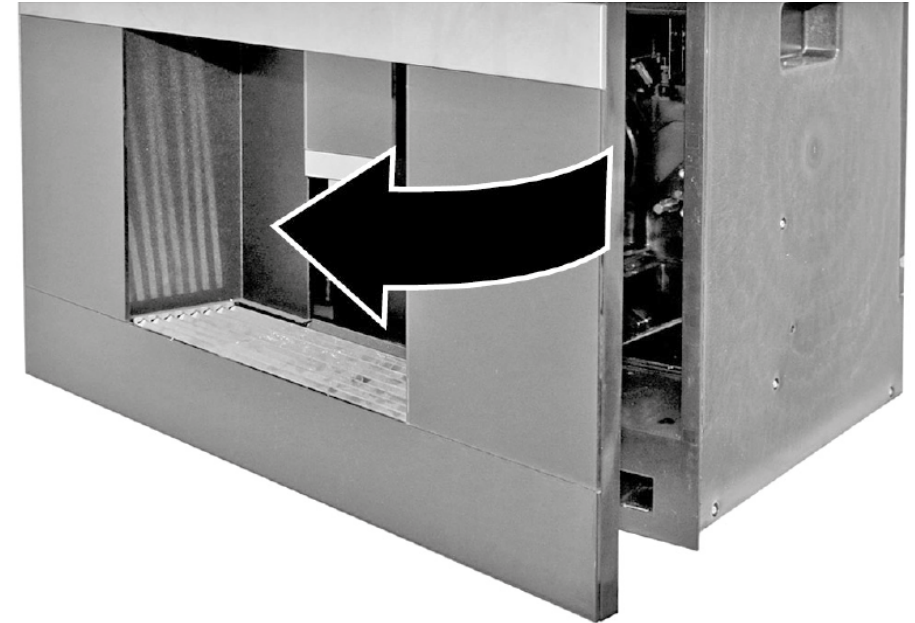

2. Tõmmake jookide väljalaskesüsteemi kate ära ja eemaldage.

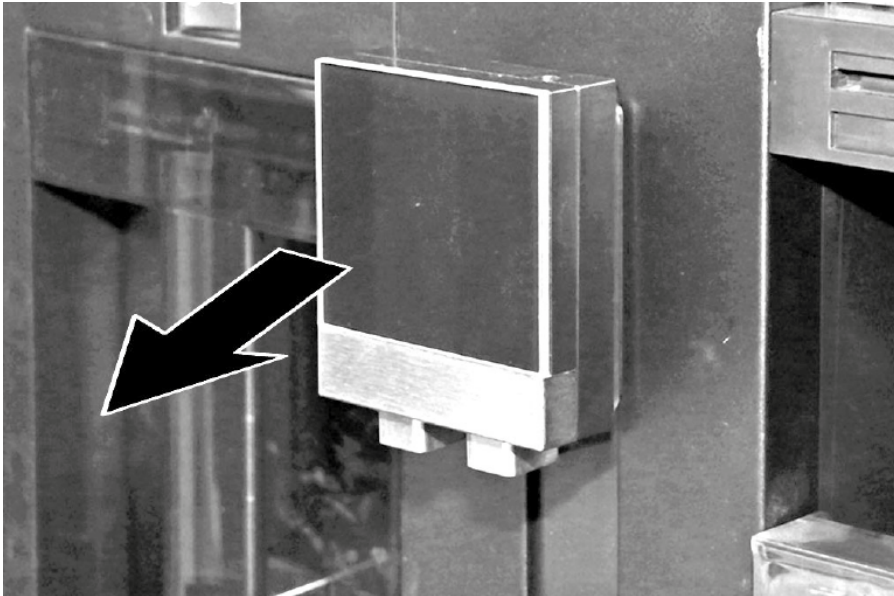

3. Tõmmake jookide väljalaskesüsteemi jaotur välja ja eemaldage.

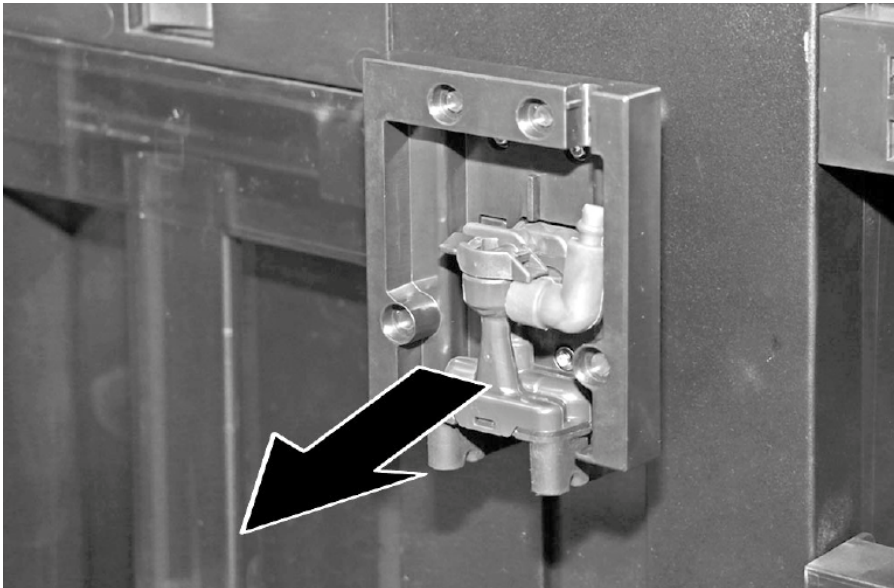

4. Keerake väljalaskesüsteemi tugiraamil neli kruvi lahti.

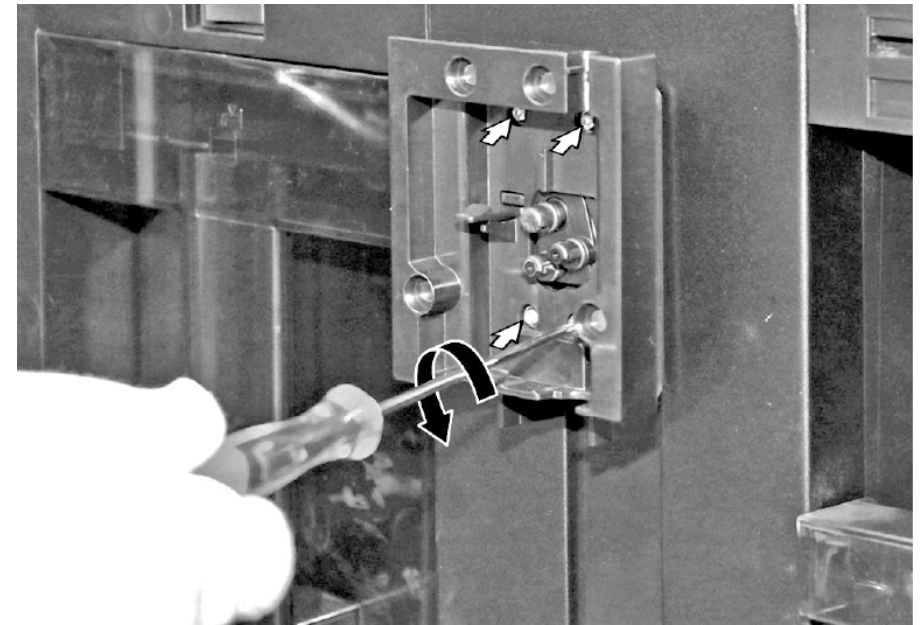

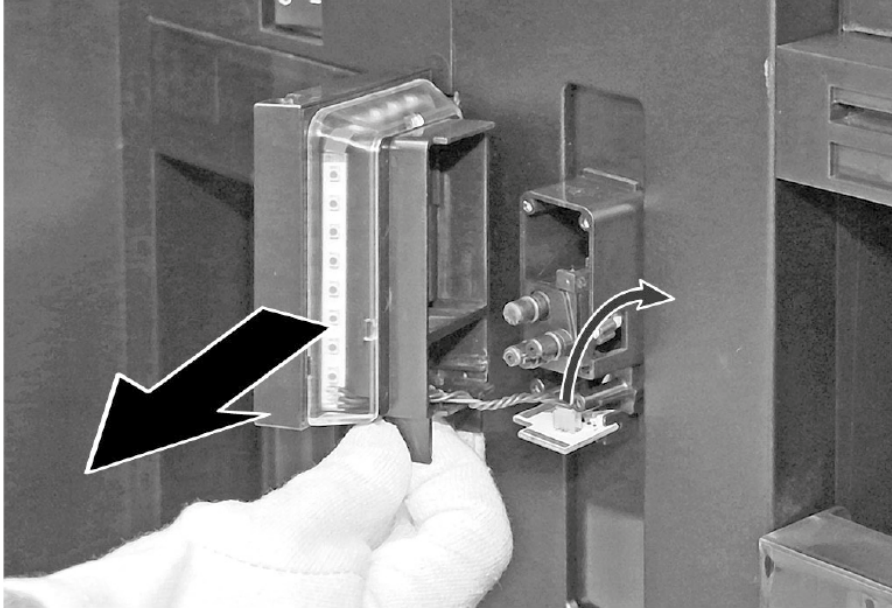

5. Tõmmake väljalaskesüsteemi tugiraam välja, lahutage elektripistik ja eemaldage väljalaskesüsteemi tugiraam.



- ➡ Jookide väljalaskesüsteemi tugiraami tagumine kate koos topsitule ja joogiava valgustusega on eemaldatud.

Korjausvinkit - Kahviautomaatti

 Tämä asiakirja	59
1.1 Tärkeitä tietoja.....	59
1.1.1 Tarkoitus	59
1.2 Symboleiden merkitys.....	59
1.2.1 Vaaratasot.....	59
1.2.2 Varoitusmerkit.....	59
1.2.3 Varoitusten rakenne	60
1.2.4 Yleiset symbolit.....	60
 Turvallisuus	61
2.1 Yleiset turvallisuusohjeet.....	61
2.1.1 Kaikki kotitalouskoneet.....	61
 Työkalut ja apuvälineet	62
 Korjaus	63
4.1 Juomasuuttimen tukikehyksen takakannen, kupin valaistuksen ja kohdevalon irrotus	63

Tämä asiakirja

1.1 Tärkeitä tietoja

1.1.1 Tarkoitus

Näiden korjausohjeiden tarkoituksena on auttaa kuluttajaa korjaamaan laitteita itse ekologista suunnittelua koskevan asetuksen (päivitys 03/2021) mukaisesti.



Ne sisältävät tietoja siitä, miten määrätyt varaosat voidaan vaihtaa. Lisäksi niihin sisältyy tietoja varoituksista ja riskeistä.

Ota yhteyttä huoltopalveluun, jos sinulla on kysyttävää. Vastamme vahingoista vain, jos korjausohjeita on noudatettu oikein.

1.2 Symboleiden merkitys

1.2.1 Vaaratasot

Varoitustasot koostuvat symbolista ja huomiosanasta. Huomiosanat ilmoittava vaaran vakavuuden.

Varoitustaso	Merkitys
 VAARA	Varoituksen laiminlyönti johtaa kuolemaan tai vakaviin loukkaantumisiin.
 VAROITUS	Varoituksen laiminlyönti voi johtaa kuolemaan tai vakaviin loukkaantumisiin.
 HUOMAA	Varoituksen laiminlyönti voi johtaa lieviin loukkaantumisiin.
HUOMIO!	Varoituksen laiminlyönti voi johtaa omaisuusvahinkoihin.

Taulukko 1: Vaaratasot

1.2.2 Varoitusmerkit

Varoitusmerkit ovat symboleita sisältäviä esityksiä, jotka osoittavat vaaran tyyppin.

Tässä asiakirjassa käytetään seuraavia varoitusmerkkejä:

Varoitusmerkki	Merkitys
	Yleinen varoitus
	Sähköjännitteestä aiheutuva vaara
	Räjähdysvaara
	Viiltohaavojen vaara
	Murskautumisen vaara

Tämä asiakirja

Varoitusmerkki	Merkitys
	Kuumista pinnoista aiheutuva vaara
	Voimakkaasta magneettikentästä aiheutuva vaara
	Ionisoimattomasta säteilystä aiheutuva vaara



Taulukko 2: Varoitusmerkit

1.2.3 Varoitusten rakenne

Tämän asiakirjan sisältämällä varoituksilla on standardoitu ulkonäkö ja rakenne.



	<div style="background-color: red; color: white; padding: 2px; text-align: center;"> VAARA</div> <p>Vaaran tyyppi ja lähde! Vaaran/varoituksen laiminlyönnistä mahdollisesti aiheutuvat seuraukset.</p> <ul style="list-style-type: none">▶ Vaaran ehkäisemiseen liittyvät toimenpiteet ja kiellot.
----------------------------------------------------------------------------------	----------------------------------------------------------------------------------------------------------------------------------------------------------------------------------------------------------------------------------------------------------------------------------------------------------------------------------------------------------------------------------------------------------------------

Seuraavassa esimerkissä näytetään varoitus, joka varoittaa jännitteisten osien aiheuttamasta sähköiskusta. Vaaran välttämiseksi suoritettava toimenpide mainitaan.

	<div style="background-color: red; color: white; padding: 2px; text-align: center;"> VAARA</div> <p>Jännitteisten osien aiheuttama sähköiskun vaara! Sähköiskun aiheuttama kuolema</p> <ul style="list-style-type: none">▶ Erotta laitteet sähkövirrasta vähintään 60 sekuntia ennen korjaustöiden aloittamista.
-----------------------------------------------------------------------------------	-----------------------------------------------------------------------------------------------------------------------------------------------------------------------------------------------------------------------------------------------------------------------------------------------------------------------------------------------------------------------------------------------------------------------------------

1.2.4 Yleiset symbolit

Tässä asiakirjassa käytetään seuraavia yleisiä symboleja:

Yl. symboli	Merkitys
	Erikoisohjeen tunniste (teksti ja/tai kaavio)
	Yksinkertaisen ohjeen tunniste (vain teksti)

Yl. symboli	Merkitys
	Video-opetusohjelmaan johtavan linkin tunniste
	Tarvittavien työkalujen tunniste
	Tarvittavien edellytysten tunniste
	Ehdon (jos ..., sitten ...) tunniste
	Tuloksen tunniste
	Näppäimen tai painikkeen tunniste
	Materiaalinumeron tunniste
	Näytetyn tekstin/ikkunan (laitteen näytössä) tunniste

Taulukko 3: Yleiset symbolit

2.1 Yleiset turvallisuusohjeet

2.1.1 Kaikki kotitalouskoneet

Jännitteisten osien aiheuttama sähköiskun vaara!

- Virheet sähkökomponentteja sisältävissä korjauksissa voivat johtaa sähköiskuun!
- Kytke kone irti verkkovirrasta vähintään 60 sekuntia ennen töiden aloittamista.
- Pyydä korjauksen jälkeen suorittamaan VDE 0701 -säädöksen tai maakohtaisten säädösten mukainen turvallisuustesti.

Terävistä reunoista aiheutuva loukkaantumisvaara!

- Käytä suojakäsineitä.

Painavista ja liikkuvista komponenteista aiheutuva murskautumisen riski korjauksen, kunnossapidon, vianetsinnän ja huollon aikana

- Käytä suojakenkiä.
- Estä painavien komponenttien putoaminen.
- Älä koske liikkuviin komponentteihin.

Laitteen turvallisuudelle/toiminnalle aiheutuva riski!

- Käytä vain alkuperäisiä varaosia.

Staattiselle sähkölle herkkien komponenttien (ESDS) vaurioitumisen riski!

- Älä koske moduuleihin, liitännät ja johdinreitit mukaan luettuna.

Työkalut ja apuvälineet

Nimitys	Yksityiskohdat	Kuvat
Torx-kärki TX10 [00340864]	6,3 mm (1/4")	

4.1 Juomasuuttimen tukikehyksen takakannen, kupin valaistuksen ja kohdevalon irrotus

Erikoistyökalut:

Torx-kärki TX10 6,3 mm (1/4") [00340864]

 Laite on varustettu huoltovapaalla LED-valolla. Vain huoltopalvelu tai valtuutetut teknikot saavat korjata nämä valot!

 **VAARA**
Jännitteisten osien aiheuttama sähköiskun vaara!
 Sähköiskusta aiheutuva hengenvaara väärän korjauksen tapauksessa

- ▶ Sähköosien korjaus tulisi antaa pätevien sähköasentajien suoritettavaksi.
- ▶ Pyydä korjauksen jälkeen suorittamaan VDE 0701 -säädöksen tai maakohtaisten säädösten mukainen turvallisuustesti.

 **VAARA**
Jännitteisten osien aiheuttama sähköiskun vaara!
 Sähköiskun aiheuttama kuolema

- ▶ Erotta laitteet sähkövirrasta vähintään 60 sekuntia ennen korjaustöiden aloittamista.

 **HUOMAA**
Terävät reunat!
 Viiltovammat

- ▶ Käytä suojakäsineitä.

 **HUOMIO!**
Staattiselle sähköille herkkien komponenttien (ESD) vaurioitumisen riski!!
 Komponentit vahingoittuvat

- ▶ Ennen koskettamista ESD-komponenttiin käytä elektrostaattista suojajärjestelmää (rannehihna maadoitustulpalla).
- ▶ Älä koske moduulien liitäntöihin, johdinreitit mukaan luettuna.
- ▶ Kuljeta ESD-komponentteja sähköä johtavissa materiaaleissa tai alkuperäisissä pakkauksissa.
- ▶ Pidä ESD-komponentit poissa sähköisesti latautuvista materiaaleista (esim. muovista).

Vaatus:

-  Kone on erotettu tehollanteesta.
- 1. Avaa laitteen etuluukku.

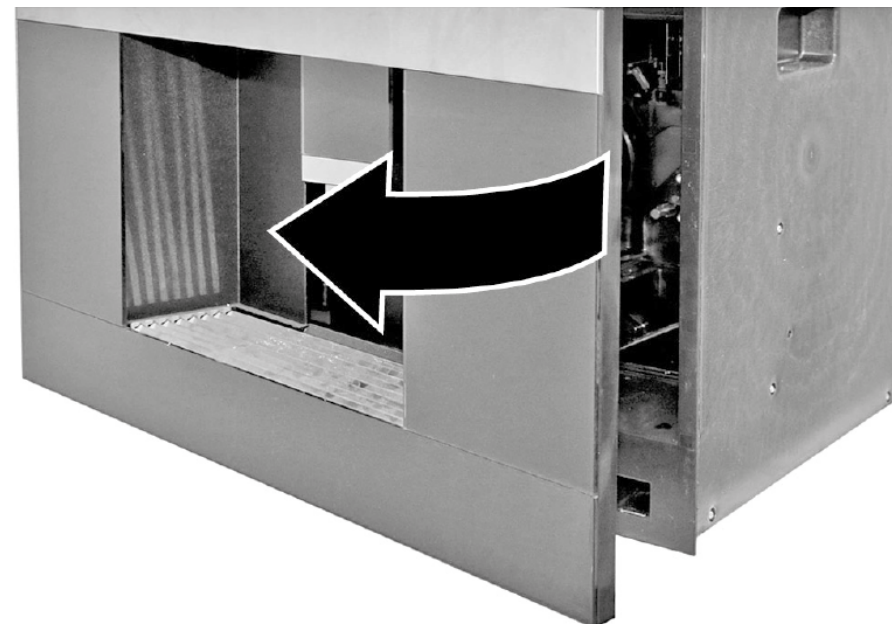

2. Vedä ulos ja poista juomasuuttimen kansi.

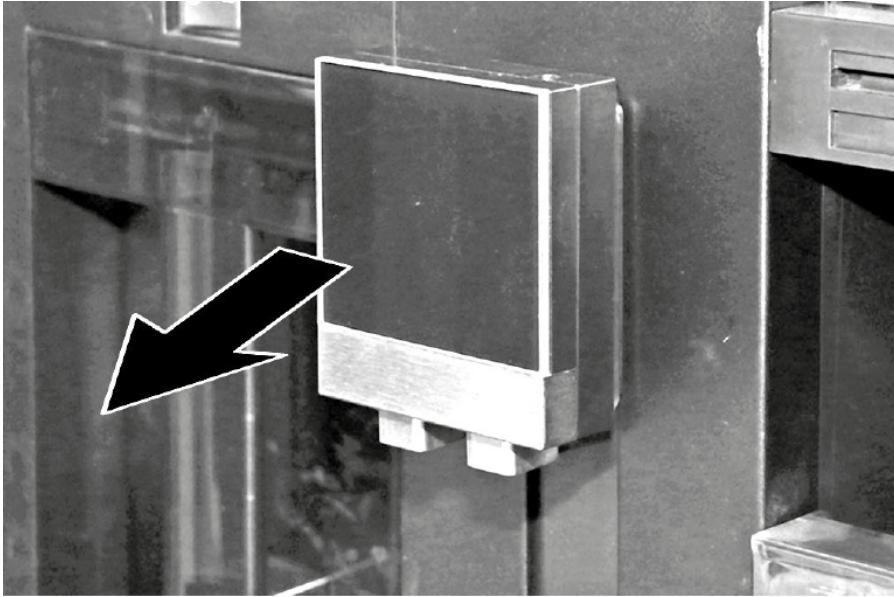

3. Vedä ulos ja poista juomasuuttimen jakelija.

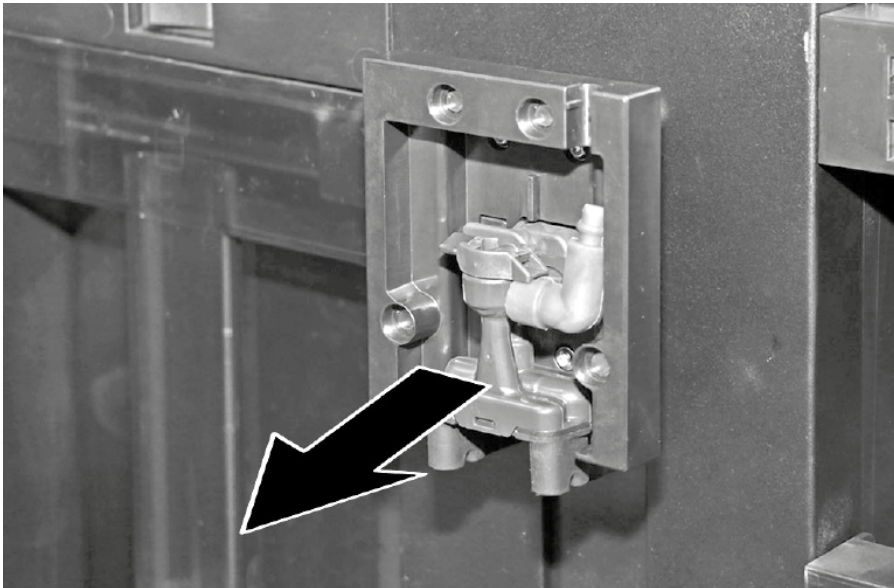

4. Kierrä neljä ruuvia auki suuttimen tukikehyksellä.

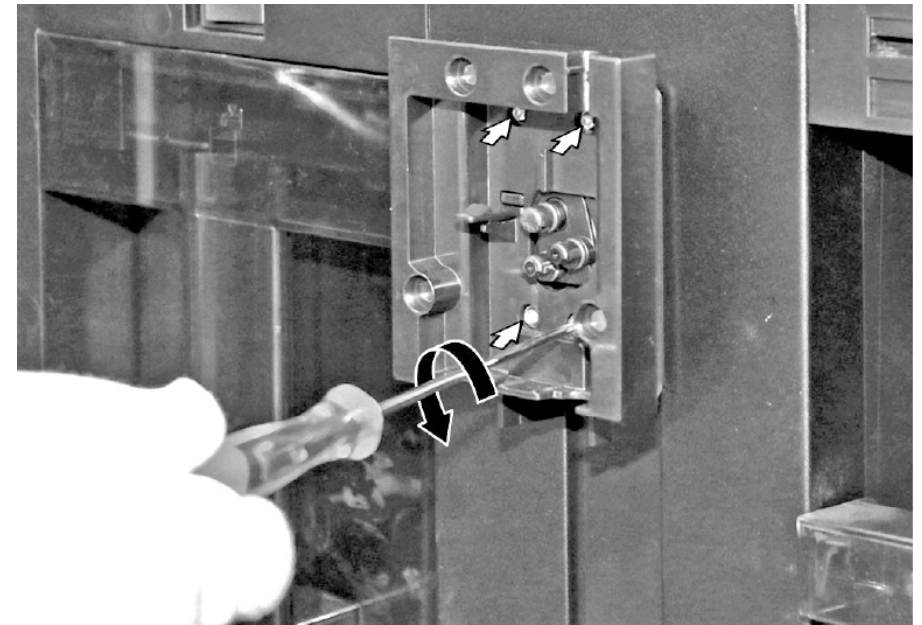



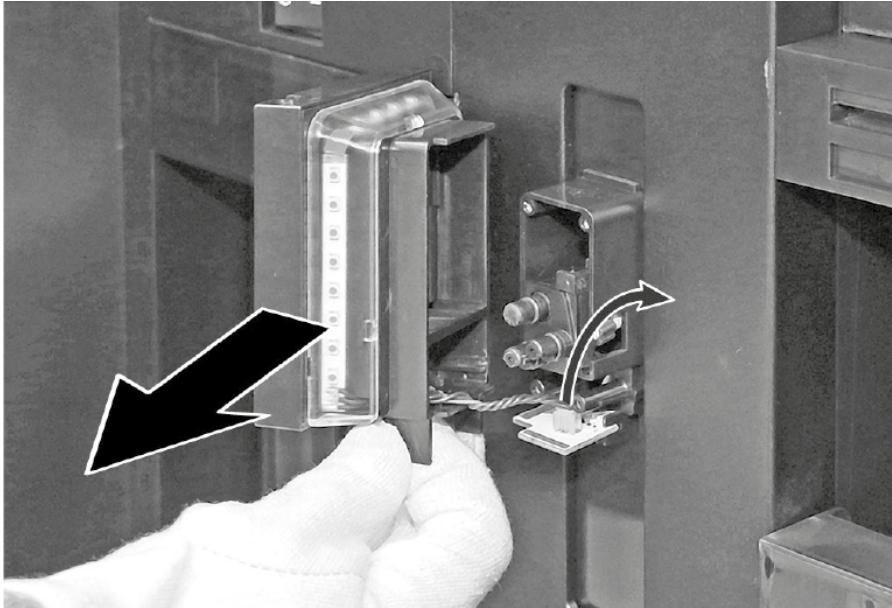

5. Vedä poistoaukon tukikehys, irrota sähköliitin ja poista suuttimen tukikehys.



- ➡ Juomasuuttimen tukikehyksen takakansi, kupin valaistus ja kohdevalo on irrotettu.

Conseils de réparation - Machine à espresso automatique

 A propos de ce document	67
1.1 Informations importantes.....	67
1.1.1 Objectif.....	67
1.2 Explication des symboles.....	67
1.2.1 Niveaux de risque.....	67
1.2.2 Symboles de danger.....	67
1.2.3 Structure des indications d'avertissement.....	68
1.2.4 Symboles généraux.....	68
 Sécurité	69
2.1 Consignes de sécurité générales.....	69
2.1.1 Tous les appareils électroménagers.....	69
 Outils et aides	70
 Réparation	71
4.1 Démontez l'arrière du cadre de support de la sortie de boisson avec éclairage des tasses et éclairage scénique.....	71

i A propos de ce document

1.1 Informations importantes

1.1.1 Objectif

Les conseils de réparation qui suivent aident le consommateur à réparer l'appareil par lui-même, conformément au règlement sur l'écoconception (en vigueur en 03/2021).

Ils contiennent des informations sur l'échange de certaines pièces détachées, ainsi que des avertissements et risques.

Pour toute question, veuillez contacter notre service après-vente. Nous ne serons responsables des dommages que si les indications de réparation ont été suivies correctement.

1.2 Explication des symboles

1.2.1 Niveaux de risque

Les niveaux de risque se composent d'un symbole et d'un terme d'avertissement. Le mot d'avertissement caractérise la gravité du danger.









Niveau de dangerosité	Signification
 DANGER	Le non respect de la consigne d'avertissement provoque la mort ou des blessures graves.
 AVERTISSEMENT	Le non respect de la consigne d'avertissement peut provoquer la mort ou des blessures graves.
 PRUDENCE	Le non respect de la consigne d'avertissement peut provoquer des blessures légères.
 ATTENTION !	Le non respect de la consigne d'avertissement peut provoquer des dégâts matériels.

Tableau 1: Niveaux de risque

1.2.2 Symboles de danger

Les symboles de danger sont des représentations figuratives renseignant sur la nature du danger.

Ce document utilise les symboles de danger suivants:

Symbole de danger	Signification
	Consigne d'avertissement générale
	Danger engendré par la tension électrique
	Risque d'explosion
	Risque de blessures par coupure

i A propos de ce document





Symbole de danger	Signification
	Risque de blessures par écrasement
	Danger engendré par des surfaces très chaudes
	Danger engendré par un champ magnétique puissant
	Danger engendré par un rayonnement non ionisant

Tableau 2: Symboles de danger

1.2.3 Structure des indications d'avertissement

Les consignes d'avertissement figurant dans ce document ont un aspect uniforme et une structure uniforme.

	<p>⚠ DANGER</p> <p>Type et source du danger ! Conséquences possibles en cas de non-respect du danger / de l'avertissement.</p> <ul style="list-style-type: none"> ▶ Mesures et interdictions pour éviter le danger.
----------------------------------------------------------------------------------	------------------------------------------------------------------------------------------------------------------------------------------------------------------------------------------------------------------------------------------------------

L'exemple suivant montre une consigne d'avertissement mettant en garde contre le risque d'électrocution. La mesure permettant d'éviter le danger est nommée.

	<p>⚠ DANGER</p> <p>Risque d'électrocution par des pièces conductrices de tension ! Mort par électrocution.</p> <ul style="list-style-type: none"> ▶ Débrancher l'appareil du secteur minimum 60 secondes avant de démarrer la réparation.
------------------------------------------------------------------------------------	----------------------------------------------------------------------------------------------------------------------------------------------------------------------------------------------------------------------------------------------------------------------------

1.2.4 Symboles généraux

Ce document utilise les symboles généraux suivants:







Symbole général	Signification
	Caractérisation d'une astuce particulière (texte et/ou graphique)
	Caractérisation d'une astuce simple (texte seul)
	Caractérisation d'un lien vers une vidéo
	Caractérisation d'outils nécessaires
	Caractérisation de conditions nécessaires
	Caractérisation d'une condition (si... , alors ...)
	Caractérisation d'un résultat
Start	Caractérisation d'une touche ou surface de commande
[00123456]	Caractérisation d'une référence de pièce
Statut	Caractérisation d'un texte affiché / fenêtre (sur l'afficheur)

Tableau 3: Symboles généraux

2.1 Consignes de sécurité générales

2.1.1 Tous les appareils électroménagers

Risque d'électrocution en raison de pièces sous tension!

- Des erreurs lors de réparations impliquant des composants électriques peuvent entraîner une décharge électrique!
- Débrancher l'appareil du secteur minimum 60 secondes avant de démarrer la réparation.
- Après la réparation, effectuer un test de sécurité selon VDE 0701 ou les réglementations spécifiques nationales.

Risque de blessures par coupure sur des bords tranchants!

- Porter des gants de protection.

Risque de casse durant la réparation, maintenance, dépannage et SAV en raison de composants lourds et mobiles

- Porter des chaussures de protection.
- Sécuriser les composants lourds contre le risque de chute.
- Ne pas coller les pièces du châssis sur les composants mobiles.

Risque lié à la sécurité / fonction de l'appareil!

- Utiliser uniquement des pièces détachées d'origine.

Risque d'endommagement des composants sensibles aux décharges électrostatiques!

- Ne pas toucher les modules, ni leur connexions et pistes conductrices.

Outils et aides

Désignation	Détails	Images
Embout Torx TX10 [00340864]	6,3 mm (1/4")	

4.1 Démontez l'arrière du cadre de support de la sortie de boisson avec éclairage des tasses et éclairage scénique

Outillage nécessaire:

🌀 Embout Torx TX10 6,3 mm (1/4") [00340864]

 Votre appareil comprend un éclairage LED sans maintenance. Ces lampes peuvent être réparées exclusivement par le service après-vente ou un technicien autorisé!

 **DANGER**
Risque d'électrocution en raison de pièces sous tension !
Risque d'électrocution en cas de réparation non conforme

- ▶ Les pièces électriques doivent être réparées par des techniciens qualifiés.
- ▶ Après la réparation, effectuer un test de sécurité selon VDE 0701 ou les réglementations spécifiques nationales.

 **DANGER**
Risque d'électrocution par des pièces conductrices de tension !
Mort par électrocution.

- ▶ Débrancher l'appareil du secteur minimum 60 secondes avant de démarrer la réparation.

 **PRUDENCE**
Arêtes vives !
Blessures par coupure

- ▶ Porter des gants de protection.

 **ATTENTION !**
Risque d'endommagement des composants sensibles aux décharges électrostatiques !
Dommages aux composants

- ▶ Avant tout contact de ces composants, utiliser un système de protection électrostatique (ex. bracelet de mise à la terre).
- ▶ Ne pas toucher les connexions et pistes conductrices des modules.
- ▶ Utiliser pour le transport uniquement des matériaux conducteurs ou l'emballage d'origine.
- ▶ Éloigner les composants sensibles des matériaux électrostatiques (ex. plastique).

Pré-requis:

✅ Appareil n'est pas sous tension.

1. Ouvrir la porte frontale de l'appareil.

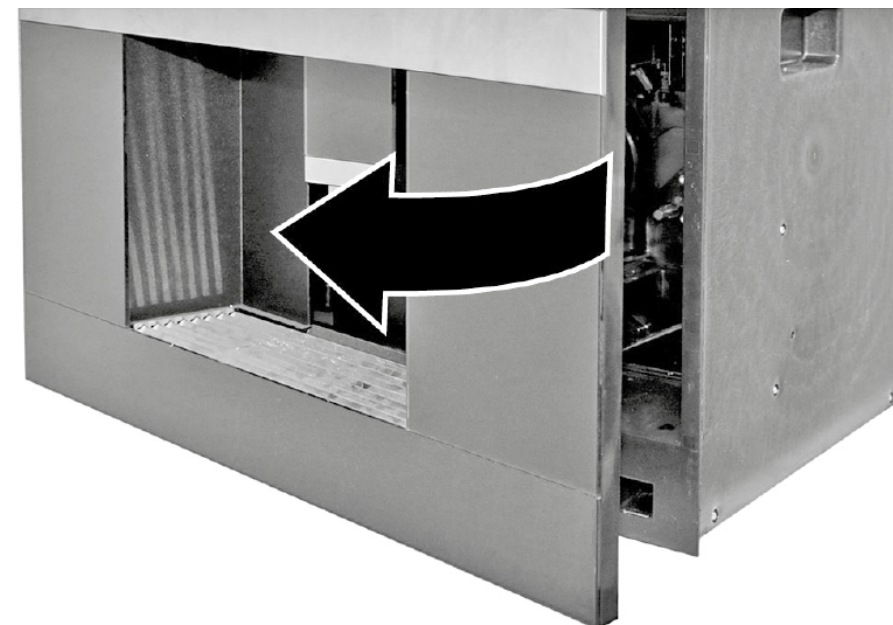

Réparation

2. Tirer sur le couvercle de la sortie de boisson pour le retirer.

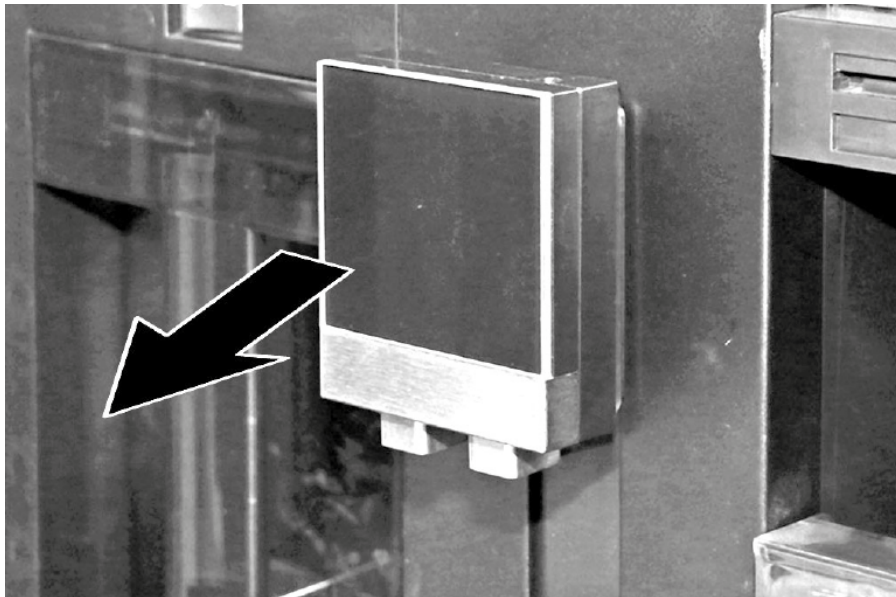

3. Tirer sur la sortie de boissons pour la retirer.

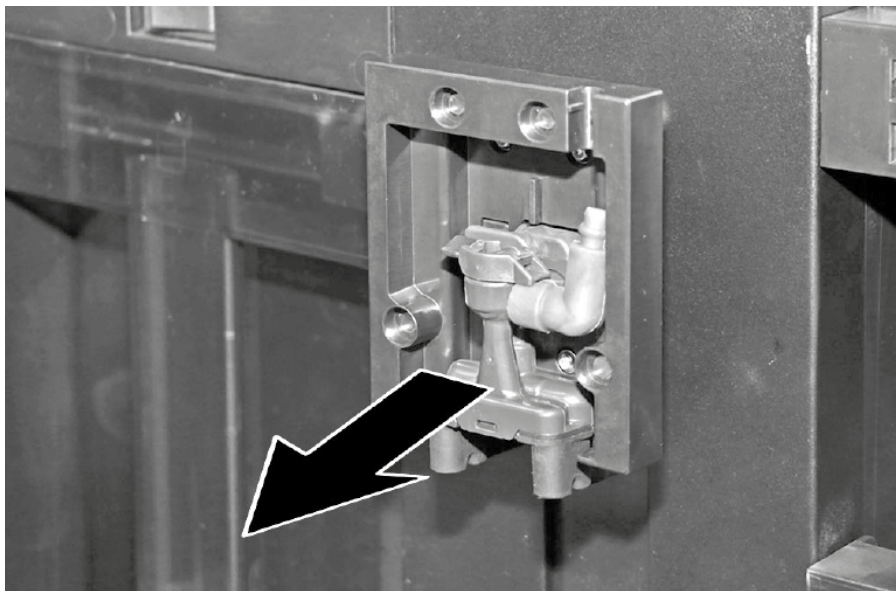

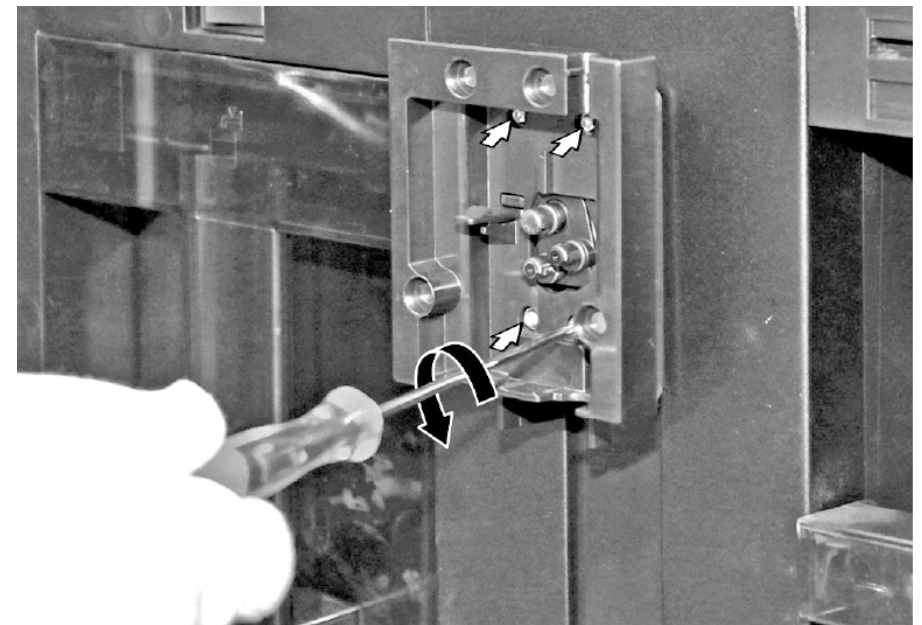

4. Dévisser quatre vis du cadre de support de la sortie.





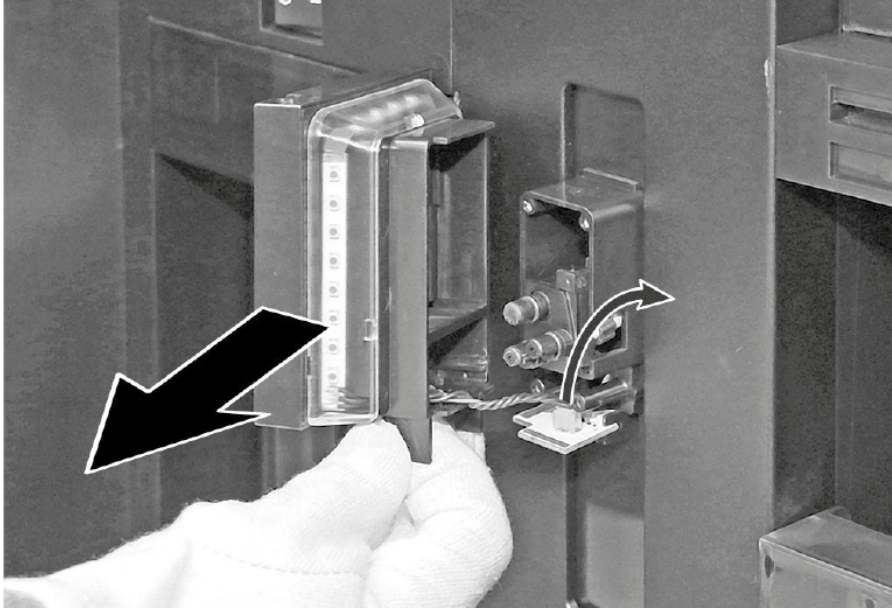

Réparation

5. Retirer le cadre du support de la sortie, débrancher le connecteur électrique et retirer le cadre du support de la sortie.



-  L'arrière du cadre de support de la sortie de boisson avec éclairage des tasses et éclairage scénique est retiré.

Reparatur Hinweise - Kaffeevollautomat

 Zu diesem Dokument	75
1.1 Wichtige Hinweise:	75
1.1.1 Zweck	75
1.2 Zeichenerklärung.....	75
1.2.1 Gefahrenstufen	75
1.2.2 Gefahrensymbole.....	75
1.2.3 Struktur der Warnhinweise.....	76
1.2.4 Allgemeine Symbole	76
 Sicherheit	77
2.1 Allgemeine Sicherheitshinweise	77
2.1.1 Alle Hausgeräte	77
 Werkzeuge und Hilfsmittel	78
 Instandsetzen	79
4.1 Ausbauen der rückseitigen Abdeckung des Getränkeauslauf-Trägerrahmens mit Tassenbeleuchtung und Beleuchtung des Ausgabebereichs.....	79

Zu diesem Dokument

1.1 Wichtige Hinweise:

1.1.1 Zweck

Diese Reparaturhinweise dienen zur Unterstützung des Kunden bei der selbständigen Geräte-Reparatur gemäß der entsprechenden Ökodesign-Richtlinie (ab 03/2021).

Sie enthalten Informationen zum Austausch bestimmter Ersatzteile sowie Warn- und Gefahrenhinweise.

Bitte wenden Sie sich in Zweifelsfällen an unseren Kundendienst. Bei nicht ordnungsgemäßer Befolgung der Reparaturhinweise ist die Schadenshaftung ausgeschlossen.

1.2 Zeichenerklärung

1.2.1 Gefahrenstufen

Die Gefahrenstufen bestehen aus einem Symbol und einem Signalwort. Das Signalwort kennzeichnet die Schwere der Gefahr.









Gefahrenstufe	Bedeutung
	Nichtbeachtung des Warnhinweises führt zu Tod oder schweren Verletzungen.
	Nichtbeachtung des Warnhinweises kann zu Tod oder schweren Verletzungen führen.
	Nichtbeachtung des Warnhinweises kann zu leichten Verletzungen führen.
	Nichtbeachtung des Warnhinweises kann zu Sachschäden führen.

Tabelle 1: Gefahrenstufen

1.2.2 Gefahrensymbole

Gefahrensymbole sind sinnbildliche Darstellungen, die einen Hinweis auf die Art der Gefahr geben.

In diesem Dokument werden folgende Gefahrensymbole verwendet:

Gefahrensymbol	Bedeutung
	Allgemeiner Warnhinweis
	Gefahr durch elektrische Spannung
	Gefahr durch Explosion
	Gefahr von Schnittverletzungen
	Gefahr von Quetschverletzungen

Zu diesem Dokument





Gefahrensymbol	Bedeutung
	Gefahr durch heiße Oberflächen
	Gefahr durch starkes Magnetfeld
	Gefahr durch nicht ionisierende Strahlung

Tabelle 2: Gefahrensymbole

1.2.3 Struktur der Warnhinweise

Warnhinweise haben in diesem Dokument ein einheitliches Aussehen und eine einheitliche Struktur.



	<div style="background-color: red; color: white; padding: 2px; text-align: center;"> GEFAHR</div> <p>Art und Quelle der Gefahr! Mögliche Folgen bei Nichtbeachtung der Gefahr / des Warnhinweises.</p> <ul style="list-style-type: none"> ▶ Maßnahmen und Verbote zur Vermeidung der Gefahr.
----------------------------------------------------------------------------------	----------------------------------------------------------------------------------------------------------------------------------------------------------------------------------------------------------------------------------------------------------------------------------------------------------------------------------------------------------------------------------------------------------------

Das folgende Beispiel zeigt einen Warnhinweis, der vor Stromschlaggefahr durch spannungsführende Teile warnt. Die Maßnahme zur Vermeidung der Gefahr wird genannt.

	<div style="background-color: red; color: white; padding: 2px; text-align: center;"> GEFAHR</div> <p>Stromschlaggefahr durch spannungsführende Teile! Tod durch Stromschlag</p> <ul style="list-style-type: none"> ▶ Gerät mindestens 60 Sekunden vor Reparaturbeginn vom Netz trennen.
------------------------------------------------------------------------------------	-------------------------------------------------------------------------------------------------------------------------------------------------------------------------------------------------------------------------------------------------------------------------------------------------------------------------------------------------------------------------------------------------------------

1.2.4 Allgemeine Symbole

In diesem Dokument werden folgende allgemeine Symbole verwendet:

Allg. Symbol	Bedeutung
	Kennzeichnung eines besonderen (Text und/oder Grafik) Tipps
	Kennzeichnung eines einfachen (nur Text) Tipps





Allg. Symbol	Bedeutung
	Kennzeichnung eines Links zu einer Videoanleitung
	Kennzeichnung erforderlicher Werkzeuge
	Kennzeichnung erforderlicher Voraussetzungen
	Kennzeichnung einer Bedingung (Wenn ..., dann ...)
	Kennzeichnung eines Ergebnisses
[Start]	Kennzeichnung einer Taste oder Schaltfläche
[00123456]	Kennzeichnung einer Materialnummer
Status	Kennzeichnung eines angezeigten Textes / Fensters (im Gerätedisplay)

Tabelle 3: Allgemeine Symbole

2.1 Allgemeine Sicherheitshinweise

2.1.1 Alle Hausgeräte

Stromschlaggefahr durch spannungsführende Teile!

- Wenn elektrische Komponenten fehlerhaft repariert werden, besteht Stromschlaggefahr!
- Das Gerät mindestens 60 Sekunden vor Beginn der Arbeiten vom Netz trennen.
- Nach der Reparatur muss eine Sicherheitsprüfung nach VDE 0701 oder länderspezifischen Vorschriften durchgeführt werden.

Verletzungsgefahr durch scharfe Kanten!

- Schutzhandschuhe tragen.

Quetschgefahr während Reparatur-, Wartungs-, Fehlersuche- und Servicearbeiten durch schwere sich bewegende Bauteile

- Schutzhandschuhe tragen.
- Schwere Bauteile gegen Herabfallen sichern.
- Körperteile nicht in sich bewegende Bauteile stecken.

Gefährdung der Gerätesicherheit/-funktion!

- Ausschließlich Originalersatzteile verwenden.

Gefahr der Beschädigung elektrostatisch gefährdeter Bauteile (elektrostatische Entladungen)!

- Die Module, einschließlich ihrer Anschlüsse und Leiterbahnen, keinesfalls berühren.

Werkzeuge und Hilfsmittel

Bezeichnung	Details	Bilder
Torx-Bit TX10 [00340864]	6,3 mm (1/4")	

4.1 Ausbauen der rückseitigen Abdeckung des Getränkeauslauf-Trägerrahmens mit Tassenbeleuchtung und Beleuchtung des Ausgabebereichs

Spezielle Hilfsmittel:

 Torx-Bit TX10 6,3 mm (1/4") [00340864]

 Das Gerät ist mit einer wartungsfreien LED-Beleuchtung ausgestattet. Reparaturen an dieser Beleuchtung dürfen nur vom Kundendienst oder von autorisierten Fachkräften ausgeführt werden!

 **GEFAHR**
Stromschlaggefahr durch spannungsführende Teile!
 Lebensgefahr durch Stromschlag bei unsachgemäßer Reparatur

- ▶ Elektroteile sollten von einer Elektrofachkraft repariert werden.
- ▶ Nach der Reparatur muss eine Sicherheitsprüfung nach VDE 0701 oder länderspezifischen Vorschriften durchgeführt werden.

 **GEFAHR**
Stromschlaggefahr durch spannungsführende Teile!
 Tod durch Stromschlag

- ▶ Gerät mindestens 60 Sekunden vor Reparaturbeginn vom Netz trennen.

 **VORSICHT**
Scharfe Kanten!
 Schnittverletzungen

- ▶ Schutzhandschuhe tragen.

	ACHTUNG
	<p>Gefahr der Beschädigung elektrostatisch gefährdeter Bauteile (elektrostatische Entladungen)!! Beschädigung von Bauteilen</p> <ul style="list-style-type: none"> ▶ Vor dem Berühren elektrostatisch gefährdeter Bauteile ein Elektrostatischeschutzsystem (Handgelenkband mit Erdungsbaustein) anlegen. ▶ Anschlüsse und Leiterbahnen der Module nicht berühren. ▶ Elektrostatisch gefährdete Bauteile nur in leitfähigen Materialien oder in der Originalverpackung transportieren. ▶ Elektrostatisch gefährdete Bauteile von elektrostatisch aufladbaren Materialien (z. B. Kunststoffen) fernhalten.

Voraussetzung:

-  Das Gerät ist spannungsfrei.
1. Die Fronttür des Geräts öffnen.

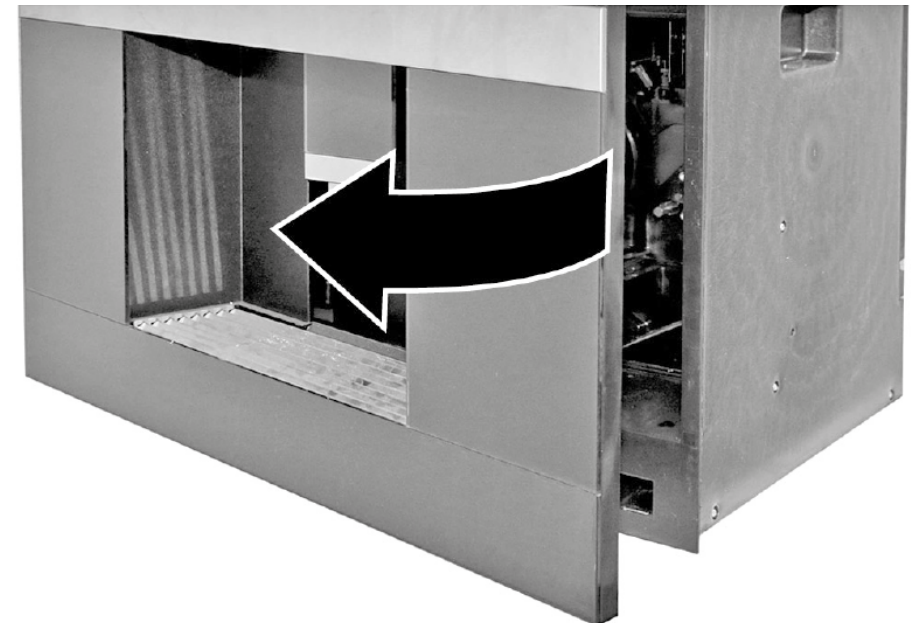

2. Die Getränkeauslaufabdeckung abziehen und entfernen.

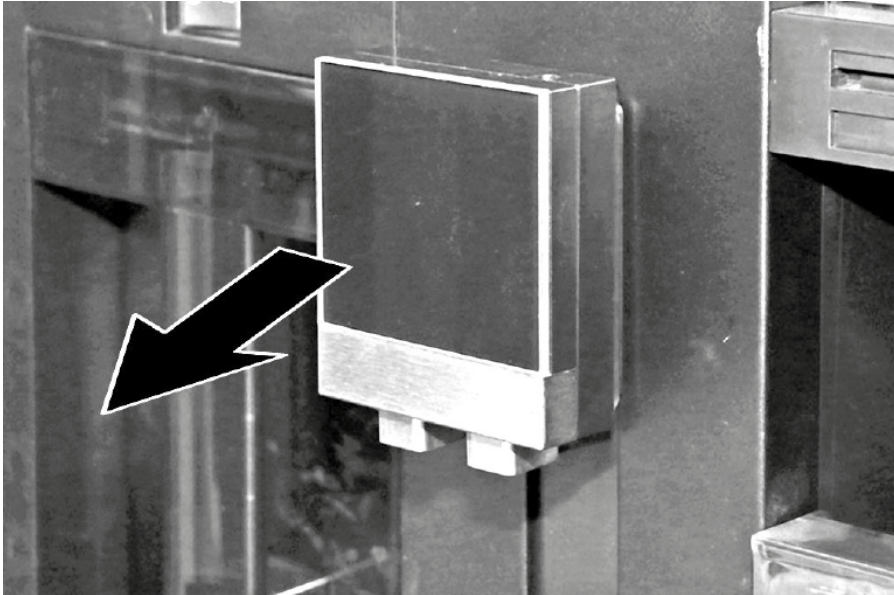

3. Den Getränkeauslaufspender herausziehen und entfernen.

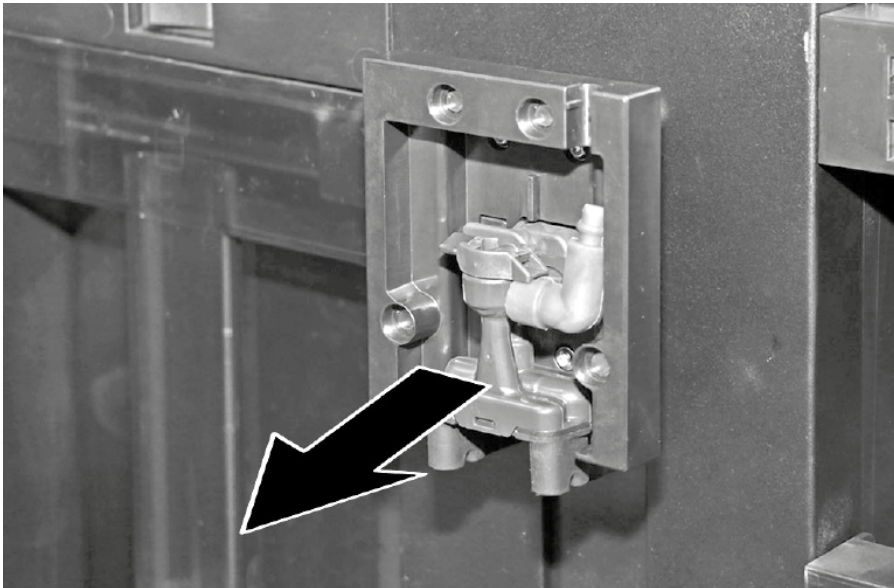

4. Die vier Schrauben am Auslaufträgerrahmen abschrauben.

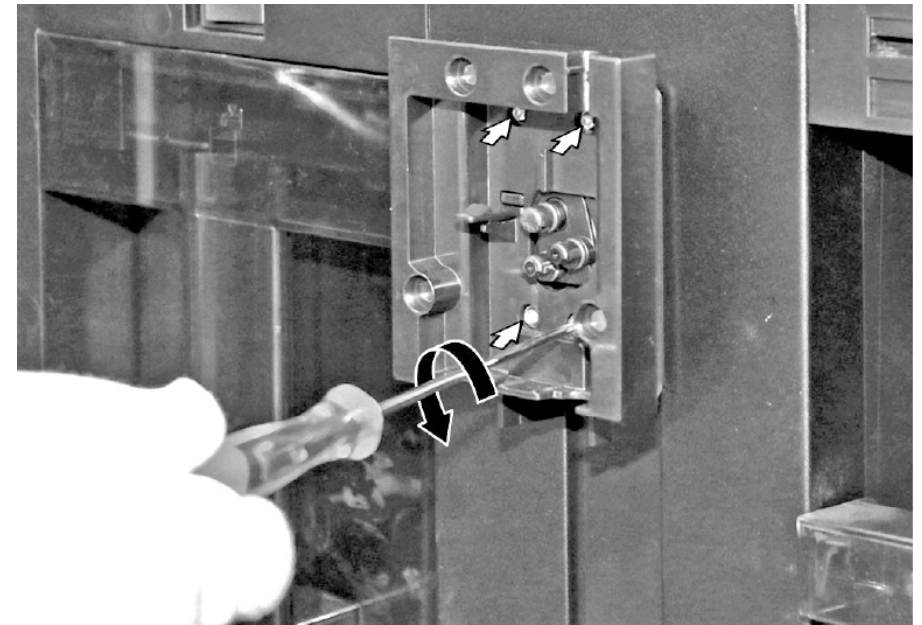



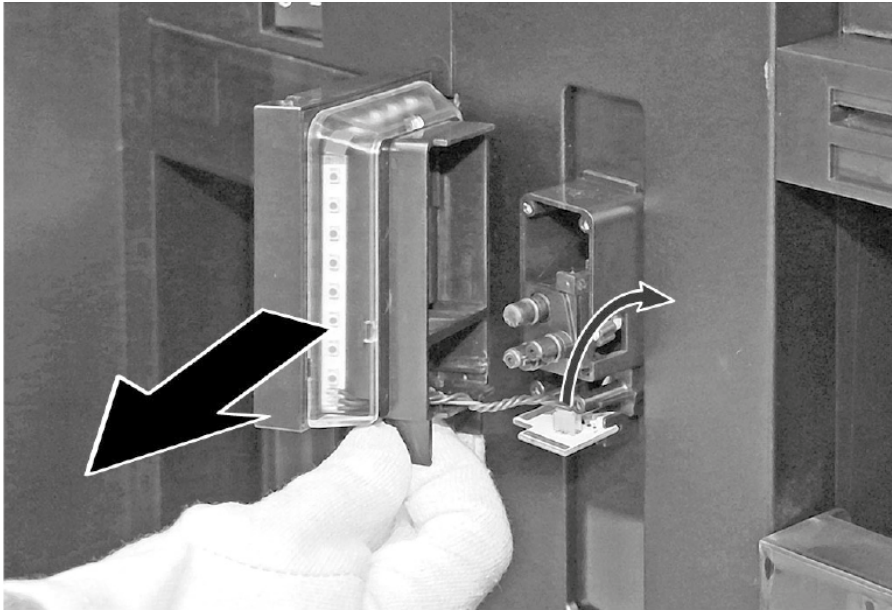

Instandsetzen

5. Den Auslaufträgerrahmen abziehen, den elektrischen Steckverbinder abziehen und den Auslaufträgerrahmen entfernen.



- ➡ Die rückseitige Abdeckung des Getränkeauslauf-Trägerrahmens mit Tassenbeleuchtung und Beleuchtung des Ausgabebereichs ist entfernt.

Υποδείξεις επισκευής - Πλήρως αυτόματη μηχανή καφέ

 Σχετικά με αυτό το έγγραφο	83
1.1 Σημαντικές πληροφορίες	83
1.1.1 Σκοπός.....	83
1.2 Επεξήγηση συμβόλων	83
1.2.1 Επίπεδα κινδύνου	83
1.2.2 Σύμβολα κινδύνου.....	83
1.2.3 Δομή των προειδοποιήσεων	84
1.2.4 Γενικά σύμβολα	84
 Ασφάλεια	85
2.1 Γενικές οδηγίες ασφαλείας	85
2.1.1 Όλες οι οικιακές συσκευές	85
 Εργαλεία και βοηθήματα	86
 Επισκευή	87
4.1 Αφαίρεση του πίσω καλύμματος του πλαισίου υποστήριξης του στομίου σερβιρίσματος ροφημάτων με φωτισμό φλιτζανιών και κεντρικό φωτισμό.....	87

i Σχετικά με αυτό το έγγραφο

1.1 Σημαντικές πληροφορίες

1.1.1 Σκοπός

Αυτές οι συμβουλές επισκευών υποστηρίζουν τους καταναλωτές στην επισκευή των συσκευών από τους ίδιους, σύμφωνα με τον ισχύοντα κανονισμό οικολογικού σχεδιασμού (από τις 03/2021).





Περιέχουν πληροφορίες για την αντικατάσταση ορισμένων ανταλλακτικών, συμπεριλαμβανομένων προειδοποιήσεων και κινδύνων.

Σε περίπτωση ερωτήσεων, επικοινωνήστε με το τμήμα εξυπηρέτησης πελατών της εταιρείας μας. Φέρουμε ευθύνη για τις ζημιές εάν οι συμβουλές επισκευής έχουν ακολουθηθεί σωστά.

1.2 Επεξήγηση συμβόλων

1.2.1 Επίπεδα κινδύνου

Τα επίπεδα προειδοποίησης ασφάλειας αποτελούνται από ένα σύμβολο και μια λέξη. Η λέξη προειδοποίησης προσδιορίζει τη σοβαρότητα του κινδύνου.





Επίπεδο προειδοποίησης	Σημασία
 ΚΙΝΔΥΝΟΣ	Η μη τήρηση του προειδοποιητικού μηνύματος θα οδηγήσει σε θάνατο ή σε σοβαρούς τραυματισμούς.
 ΠΡΟΕΙΔΟΠΟΙΗΣΗ	Η μη τήρηση του προειδοποιητικού μηνύματος θα μπορούσε να οδηγήσει σε θάνατο ή σε σοβαρούς τραυματισμούς.
 ΠΡΟΣΟΧΗ	Η μη τήρηση του προειδοποιητικού μηνύματος θα μπορούσε να οδηγήσει σε μικρούς τραυματισμούς.
 ΠΡΟΣΟΧΗ!	Η μη τήρηση του προειδοποιητικού μηνύματος θα μπορούσε να οδηγήσει σε υλικές ζημιές της ιδιοκτησίας.

Πίνακας 1: Επίπεδα κινδύνου





1.2.2 Σύμβολα κινδύνου

Τα σύμβολα κινδύνου είναι συμβολικές αναπαραστάσεις που δίνουν μια ένδειξη για το είδος του κινδύνου.

Τα ακόλουθα σύμβολα κινδύνου χρησιμοποιούνται στο παρόν έγγραφο:

Σύμβολο κινδύνου	Σημασία
	Γενικό προειδοποιητικό μήνυμα
	Κίνδυνος από ηλεκτρική τάση
	Κίνδυνος έκρηξης
	Κίνδυνος κοψίματος

i Σχετικά με αυτό το έγγραφο

Σύμβολο κινδύνου	Σημασία
	Κίνδυνος σύνθλιψης
	Κίνδυνος από καυτές επιφάνειες
	Κίνδυνος από ισχυρό μαγνητικό πεδίο
	Κίνδυνος από μη ιονίζουσα ακτινοβολία

Πίνακας 2: Σύμβολα κινδύνου

1.2.3 Δομή των προειδοποιήσεων

.Οι προειδοποιήσεις σε αυτό το έγγραφο έχουν μια τυποποιημένη εμφάνιση και μια τυποποιημένη δομή.

	⚠ ΚΙΝΔΥΝΟΣ
Είδος και πηγή κινδύνου!	
Πιθανές συνέπειες εάν αγνοήσετε τον κίνδυνο/την προειδοποίηση.	
▶ Μέτρα και απαγορεύσεις για την πρόληψη του κινδύνου.	

Το παρακάτω παράδειγμα δείχνει μια προειδοποίηση που προειδοποιεί κατά της ηλεκτροπληξίας λόγω ηλεκτροφόρων μερών. Αναφέρεται το μέτρο για την αποφυγή του κινδύνου.

	⚠ ΚΙΝΔΥΝΟΣ
Κίνδυνος ηλεκτροπληξίας λόγω ηλεκτροφόρων μερών!	
Θάνατος από ηλεκτροπληξία	
▶ Αποσυνδέετε τις συσκευές από την παροχή ηλεκτρικού ρεύματος τουλάχιστον 60 δευτερόλεπτα πριν ξεκινήσετε τις επισκευές.	

1.2.4 Γενικά σύμβολα

Τα ακόλουθα γενικά σύμβολα χρησιμοποιούνται στο παρόν έγγραφο:

Γεν. σύμβολο	Σημασία
	Ταυτοποίηση μιας ειδικής συμβουλής (κειμένου ή/και γραφικών)
	Ταυτοποίηση μιας ειδικής συμβουλής (μόνο κειμένου)
	Ταυτοποίηση συνδέσμου ή εκπαιδευτικού βίντεο
	Ταυτοποίηση απαραίτητων εργαλείων
	Ταυτοποίηση απαραίτητων προϋποθέσεων
	Ταυτοποίηση μιας συνθήκης (αν ..., κατόπιν ...)
	Ταυτοποίηση αποτελέσματος
	Ταυτοποίηση ενός πλήκτρου ή κουμπιού
[00123456]	Ταυτοποίηση ενός κωδικού ανταλλακτικού
Κατάσταση	Ταυτοποίηση εμφανιζόμενου κειμένου/ παραθύρου (στην οθόνη της συσκευής)

Πίνακας 3: Γενικά σύμβολα

2.1 Γενικές οδηγίες ασφαλείας

2.1.1 Όλες οι οικιακές συσκευές

Κίνδυνος ηλεκτροπληξίας λόγω ηλεκτροφόρων μερών!

- Τα σφάλματα από επισκευές σε ηλεκτρικά εξαρτήματα μπορεί να προκαλέσουν ηλεκτροπληξία!
- Αποσυνδέστε τη συσκευή από την πρίζα για τουλάχιστον 60 δευτερόλεπτα πριν από την έναρξη των εργασιών.
- Μετά την επισκευή πραγματοποιήστε έλεγχο ασφαλείας σύμφωνα με το VDE 0701 ή κανονισμούς της συγκεκριμένης χώρας.

Κίνδυνος τραυματισμού από κοφτερές άκρες!

- Φοράτε προστατευτικά γάντια.

Κίνδυνος σύνθλιψης κατά την επισκευή, συντήρηση, αντιμετώπιση προβλημάτων και το σέρβις από βαριά και κινούμενα μέρη

- Φοράτε προστατευτικά υποδήματα.
- Ασφαλίστε τα βαριά μέρη από πτώση.
- Μην προσαρτάτε μέρη του πλαισίου στα κινούμενα μέρη.

Κίνδυνος για την ασφάλεια/τη λειτουργία της συσκευής!

- Χρησιμοποιείτε μόνο γνήσια ανταλλακτικά.

Κίνδυνος πρόκλησης βλάβης σε μέρη ευαίσθητα στον στατικό ηλεκτρισμό (ESDs)!

- Μην αγγίζετε τις μονάδες, συμπεριλαμβανομένων των συνδέσεων και των αγωγών των πλακετών.

Εργαλεία και βοηθήματα

Όνομασία	Λεπτομέριες	Εικόνες
Μύτη-Torx TX10 [00340864]	6,3 mm (1/4")	

4.1 Αφαίρεση του πίσω καλύμματος του πλαισίου υποστήριξης του στομίου σερβιρίσματος ροφημάτων με φωτισμό φλιτζανιών και κεντρικό φωτισμό

Ειδικά βοηθητικά μέσα:

 Μύτη-Torx TX10 6,3 mm (1/4") [00340864]

	<p>Η συσκευή διαθέτει ένα φως LED που δεν χρειάζεται συντήρηση. Αυτά τα φώτα μπορούν να επισκευαστούν μόνο από την εξυπηρέτηση πελατών ή από εξουσιοδοτημένους τεχνικούς!</p>
-----------------------------------------------------------------------------------	-------------------------------------------------------------------------------------------------------------------------------------------------------------------------------

	⚠ ΚΙΝΔΥΝΟΣ
<p>Κίνδυνος ηλεκτροπληξίας λόγω ηλεκτροφόρων μερών! Κίνδυνος για τη ζωή από ηλεκτροπληξία σε περίπτωση ακατάλληλης επισκευής</p> <ul style="list-style-type: none"> ▶ Τα ηλεκτρικά μέρη πρέπει να επισκευάζονται από εκπαιδευμένους ηλεκτρολόγους. ▶ Μετά την επισκευή πραγματοποιήστε έλεγχο ασφάλειας σύμφωνα με το VDE 0701 ή κανονισμούς της συγκεκριμένης χώρας. 	

	⚠ ΚΙΝΔΥΝΟΣ
<p>Κίνδυνος ηλεκτροπληξίας λόγω ηλεκτροφόρων μερών! Θάνατος από ηλεκτροπληξία</p> <ul style="list-style-type: none"> ▶ Αποσυνδέετε τις συσκευές από την παροχή ηλεκτρικού ρεύματος τουλάχιστον 60 δευτερόλεπτα πριν ξεκινήσετε τις επισκευές. 	

	⚠ ΠΡΟΣΟΧΗ
<p>Αιχμηρές ακμές! Τραυματισμοί από κοπή</p> <ul style="list-style-type: none"> ▶ Φοράτε προστατευτικά γάντια. 	

	ΠΡΟΣΟΧΗ!
<p>Κίνδυνος πρόκλησης βλάβης σε μέρη ευαίσθητα στον στατικό ηλεκτρισμό (ESDs)! Ζημιά στοιχείων</p> <ul style="list-style-type: none"> ▶ Πριν αγγίξετε εξαρτήματα ευαίσθητα στον στατικό ηλεκτρισμό (eSDS) χρησιμοποιήστε ένα σύστημα ηλεκτροστατικής προστασίας (βραχιολάκι ασφαλείας και σύνδεση με τη γη). ▶ Μην αγγίζετε τις συνδέσεις και τους αγωγούς των πλακετών. ▶ Κατά την μεταφορά εξαρτημάτων ευαίσθητα στον στατικό ηλεκτρισμό (ESDs) ή αγωγίμων υλικών θα πρέπει να μεταφέρονται στην αρχική τους συσκευασία. ▶ Κρατήστε τα εξαρτήματα ευαίσθητα στον στατικό ηλεκτρισμό (ESDs) μακριά από ηλεκτροστατικά φορτισμένα υλικά (π.χ. πλαστικά). 	

Προϋπόθεση:

-  Η συσκευή είναι αποσυνδεδεμένη από την παροχή τροφοδοσίας.
1. Ανοίξτε την μπροστινή πόρτα της συσκευής.

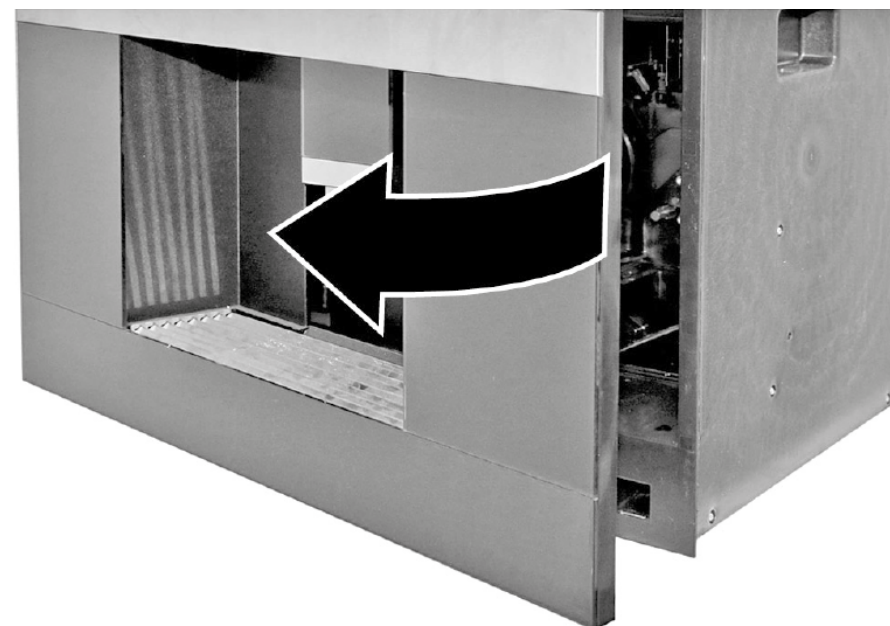

2. Τραβήξτε προς τα έξω και αφαιρέστε το κάλυμμα του στομίου σερβιρίσματος ροφημάτων.

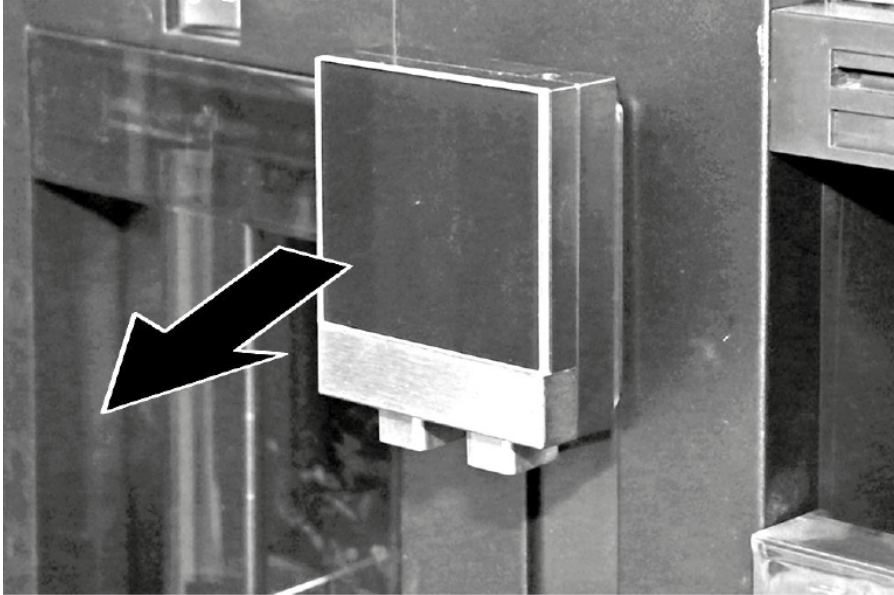

3. Τραβήξτε προς τα έξω και αφαιρέστε το δοχείο του στομίου σερβιρίσματος ροφημάτων.

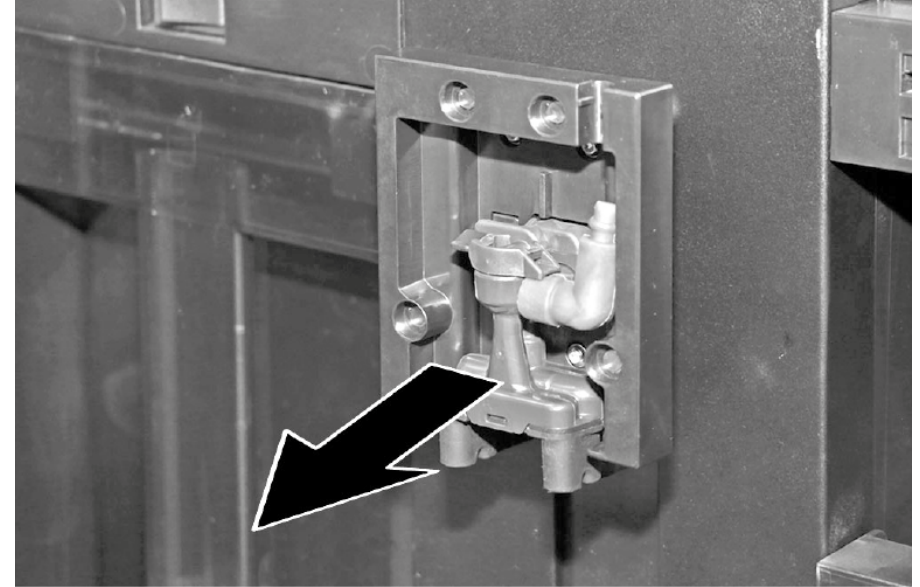

4. Ξεβιδώστε τέσσερις βίδες στο πλαίσιο υποστήριξης του στομίου σερβιρίσματος.

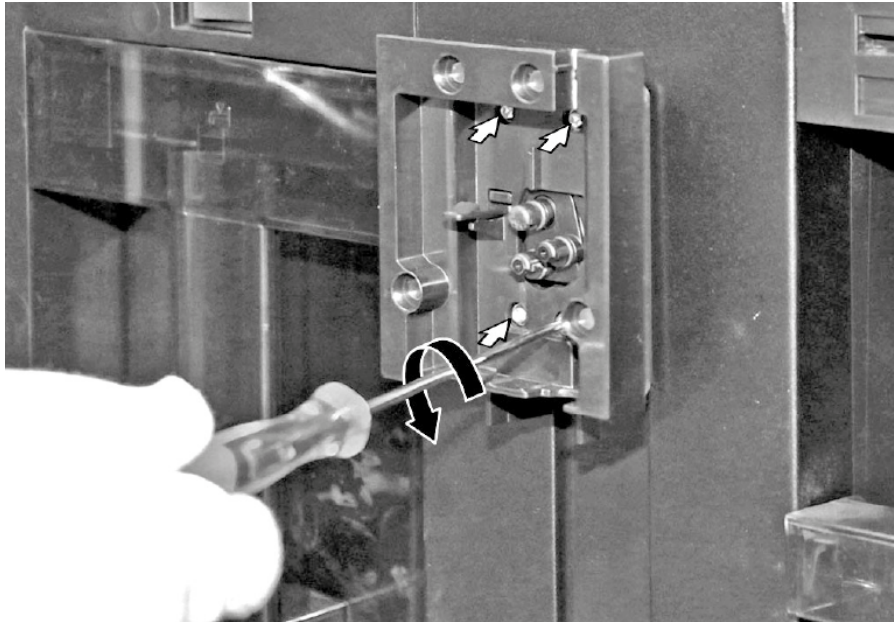



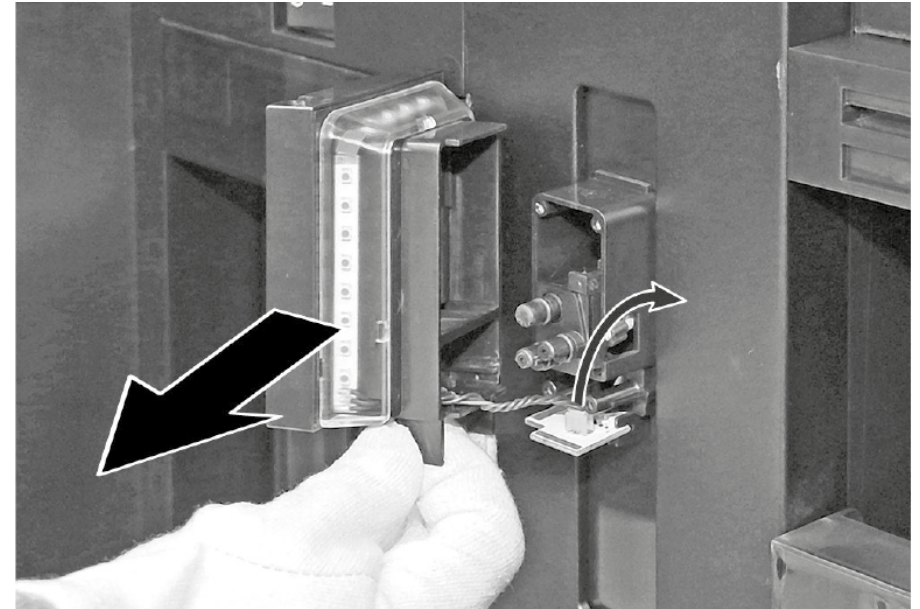

5. Τραβήξτε προς τα έξω το πλαίσιο υποστήριξης του στομίου σερβιρίσματος, αποσυνδέστε τον ηλεκτρικό σύνδεσμο και αφαιρέστε το πλαίσιο υποστήριξης του στομίου σερβιρίσματος.



- ➡ Αφαιρέθηκε το πίσω κάλυμμα του πλαισίου υποστήριξης του στομίου σερβιρίσματος ροφημάτων με φωτισμό φλιτζανιών και κεντρικό φωτισμό.

Javítási útmutató - Automata kávéfőző

 A dokumentummal kapcsolatos információk.....	91
1.1 Fontos tudnivalók	91
1.1.1 Cél	91
1.2 Szimbólummagyarázat	91
1.2.1 Veszélyességi szintek	91
1.2.2 Veszélyt jelző szimbólumok	91
1.2.3 A figyelmeztetések felépítése	92
1.2.4 Általános szimbólumok.....	92
 Biztonság	93
2.1 Általános biztonsági utasítások.....	93
2.1.1 Összes háztartási készülék	93
 Szerszámok és segédanyagok.....	94
 Javítás	95
4.1 Az italkifolyó-tartó keret hátsó burkolatának eltávolítása a csészévelágítással és a megvilágítással	95

i A dokumentummal kapcsolatos információk

1.1 Fontos tudnivalók

1.1.1 Cél

Ezek a javítási tanácsok támogatják a fogyasztót a készülékek otthoni megjavításában a környezettudatos tervezésről szóló rendeletnek (2021 márciusától alkalmazandó) megfelelően.

Információkat tartalmaznak bizonyos pótalkatrészek cseréjével kapcsolatban, ideértve a figyelmeztetéseket és a kockázatokat is.

Ha kérdése van, vegye fel a kapcsolatot a vevőszolgálattal. A károkért kizárólag akkor vállalunk felelősséget, ha a javítási tanácsokat pontosan betartották.

1.2 Szimbólummagyarázat

1.2.1 Veszélyességi szintek

A veszélyességi szintek egy szimbólumból és egy figyelmeztető mondatból állnak. A figyelmeztető mondat utal a veszély súlyosságára.





Veszélyességi szint	Jelentés
 VESZÉLY	A figyelmeztető üzenet figyelmen kívül hagyása halált vagy súlyos sérüléseket okoz.
 FIGYELMEZTETÉS	A figyelmeztető üzenet figyelmen kívül hagyása halált vagy súlyos sérüléseket okozhat.
 VIGYÁZAT	A figyelmeztető üzenet figyelmen kívül hagyása kisebb sérüléseket okozhat.
FIGYELEM!	A figyelmeztető üzenet figyelmen kívül hagyása anyagi károkat okozhat.

Táblázat 1: Veszélyességi szintek

1.2.2 Veszélyt jelző szimbólumok

A veszélyt jelző szimbólumok a veszélyt ábrázoló szimbolikus ábrázolások.

A jelen dokumentumban az alábbi veszélyt jelző szimbólumok használatosak:

Veszélyt jelző szimbólum	Jelentés
	Általános figyelmeztető üzenet
	Elektromos feszültség veszélye
	Robbanásveszély
	Vágásveszély
	Zúzódásveszély

i A dokumentummal kapcsolatos információk

Veszélyt jelző szimbólum	Jelentés
	Forró felületek miatt fennálló veszély
	Erős mágneses mező miatt fennálló veszély
	Nem ionizáló sugárzás veszélye

Táblázat 2: Veszélyt jelző szimbólumok

1.2.3 A figyelmeztetések felépítése

A jelen dokumentumban lévő figyelmeztetések szabványosított megjelenésűek és felépítésűek.

	<p>⚠ VESZÉLY</p> <p>A veszély típusa és forrása! A veszély / figyelmeztetés figyelmen kívül hagyásának lehetséges következményei.</p> <ul style="list-style-type: none"> ▶ A veszély megelőzésére szolgáló intézkedések és tiltások.
--	-----------------------------------------------------------------------------------------------------------------------------------------------------------------------------------------------------------------------------------------------------------------------

Az alábbi példa egy olyan figyelmeztetést mutat be, amely az áram alatt lévő alkatrészek okozta áramütésre figyelmeztet. Megemlíti a veszély elkerülésére szolgáló intézkedést.

	<p>⚠ VESZÉLY</p> <p>Áramütés veszélye áram alatt lévő alkatrészek miatt! Halálos áramütés</p> <ul style="list-style-type: none"> ▶ A javítás megkezdése előtt legalább 60 másodperccel válassza le a készülékeket az elektromos hálózatról.
--	------------------------------------------------------------------------------------------------------------------------------------------------------------------------------------------------------------------------------------------------------------------------------

1.2.4 Általános szimbólumok

A jelen dokumentumban az alábbi általános szimbólumok használatosak:

Ált. szimbólum	Jelentés
	Különleges tanács (szöveg és/vagy grafika)

Ált. szimbólum	Jelentés
	Egyszerű tanács (csak szöveg)
	Videós oktatóanyagra mutató hivatkozás
	A szükséges eszközök
	A szükséges feltételek
	Feltétel (ha..., akkor...)
	Eredmény
[Indítás]	Billentyű vagy gomb
[00123456]	Anyagszám azonosítója
Állapot	Megjelenített szöveg / ablak (a készülék kijelzőjén)

Táblázat 3: Általános szimbólumok

2.1 Általános biztonsági utasítások

2.1.1 Összes háztartási készülék

Áramütés veszélye áram alatt lévő alkatrészek miatt!

- Az elektromos alkatrészek hibás javítása áramütéshez vezethet!
- A javítás megkezdése előtt legalább 60 másodperccel válassza le a készüléket az elektromos hálózatról.
- A javítás után végeztesse a VDE 0701-nek vagy az országspecifikus szabályozásoknak megfelelő vizsgálatot.

Éles peremek miatt fennálló sérülésveszély!

- Viseljen védőkesztyűt.

Zúzódásveszély a javítás, karbantartás, hibaelhárítás és szervizelés során a nehéz és mozgó alkatrészek miatt

- Viseljen védőcipőt.
- Biztosítsa leesés ellen a nehéz alkatrészeket.
- Ne dugja be a testrészeit a mozgó alkatrészek közé.

Sérülhet a készülék biztonsága / működése!

- Kizárólag eredeti pótalkatrészeket használjon.

Elektrosztatikailag érzékeny alkatrészek (ESD-k) károsodásának veszélye!

- Ne érintse meg a modulokat, ideértve a csatlakozásokat és a vezetőket.

Szerszámok és segédanyagok

Kijelölés	Részletek	Képek
TX10 Torx bithegy [00340864]	6,3 mm (1/4")	

4.1 Az italkifolyó-tartó keret hátsó burkolatának eltávolítása a csészevilágítással és a megvilágítással

Különleges eszközök

 TX10 Torx bithegy 6,3 mm (1/4") [00340864]



A készüléke karbantartásmentes LEDvilágítással rendelkezik.
A világítást kizárólag az ügyfélszolgálat vagy szakképzett szerelő javíthatja meg!



VESZÉLY

Áramütés veszélye áram alatt lévő alkatrészek miatt!

Életveszély a nem megfelelő javítás okozta áramütés miatt

- ▶ Az elektromos alkatrészek javítását kizárólag képzett elektroműszerész végezheti.
- ▶ A javítás után végeztesen a VDE 0701-nek vagy az országspecifikus szabályozásoknak megfelelő vizsgálatot.



VESZÉLY

Áramütés veszélye áram alatt lévő alkatrészek miatt!

Halálos áramütés

- ▶ A javítás megkezdése előtt legalább 60 másodperccel válassza le a készülékeket az elektromos hálózatról.



VIGYÁZAT

Éles szélek!

Vágási sérülések

- ▶ Viseljen védőkesztyűt.



FIGYELEM!

Elektrosztatikailag érzékeny alkatrészek (ESD-k) károsodásának veszélye!!

Alkatrészek károsodása

- ▶ Az ESD-k megérintése előtt használjon elektrosztatikus védelmi rendszert (földeléssel ellátott karpántot).
- ▶ Ne érintse meg a modulok csatlakozásait és vezetőit.
- ▶ Az ESD-eket kizárólag vezetőképes anyagokban vagy az eredeti csomagolásban szállítsa.
- ▶ Tartsa távol az ESD-eket az elektrosztatikusan feltöltődő anyagoktól (pl. műanyag).

Követelmény:

-  A készüléket leválasztotta az áramellátásról.
1. Nyissa ki a készülék elülső ajtaját.

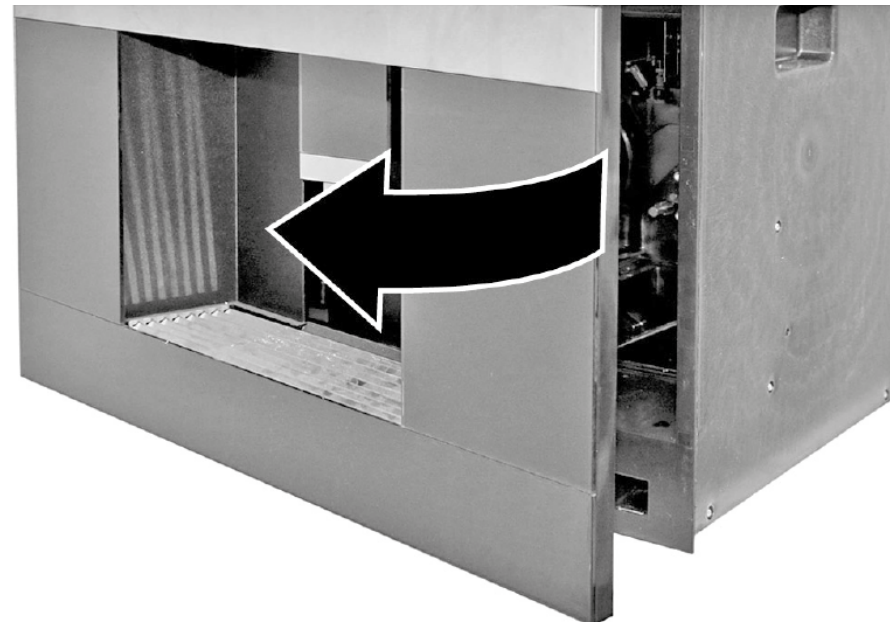

2. Húzza le és távolítsa el az italkifolyó burkolatát.

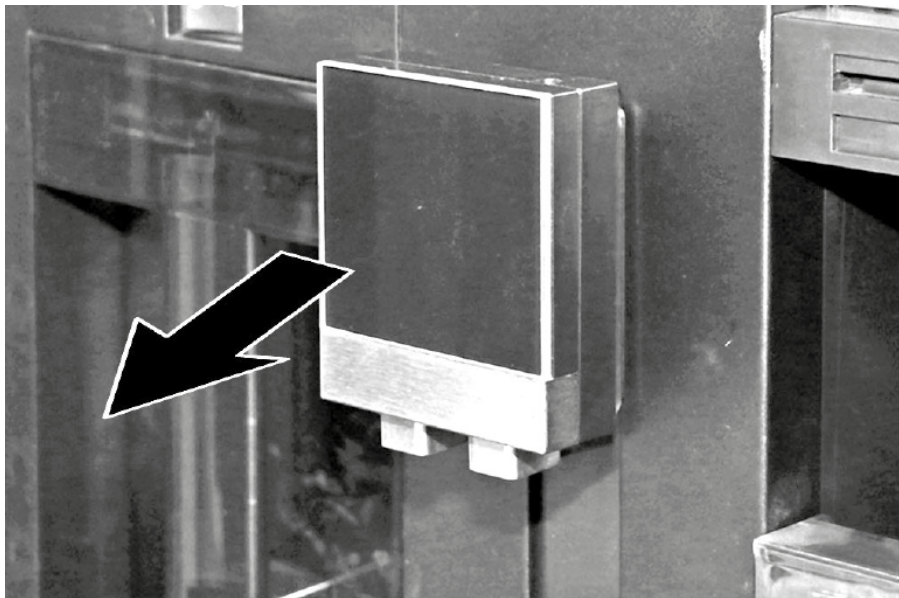

3. Húzza ki és távolítsa el az italkifolyó adagolóját.

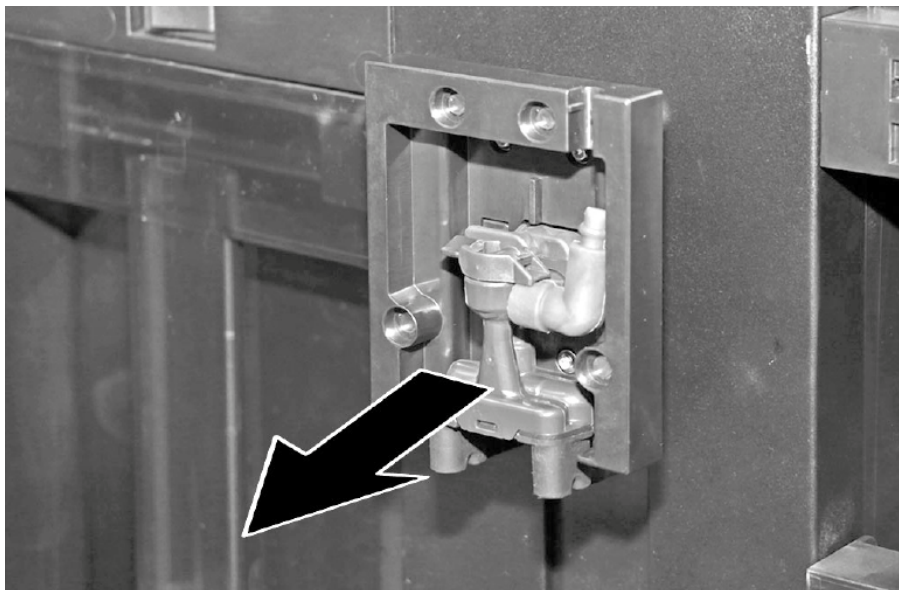

4. Csavarja ki a kiadótartó keret mind a négy csavarját.

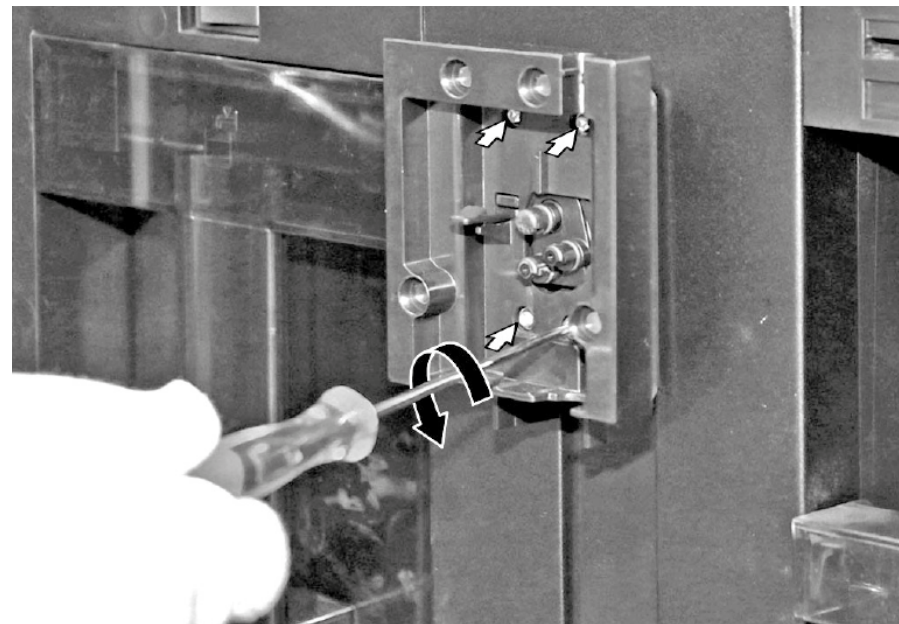



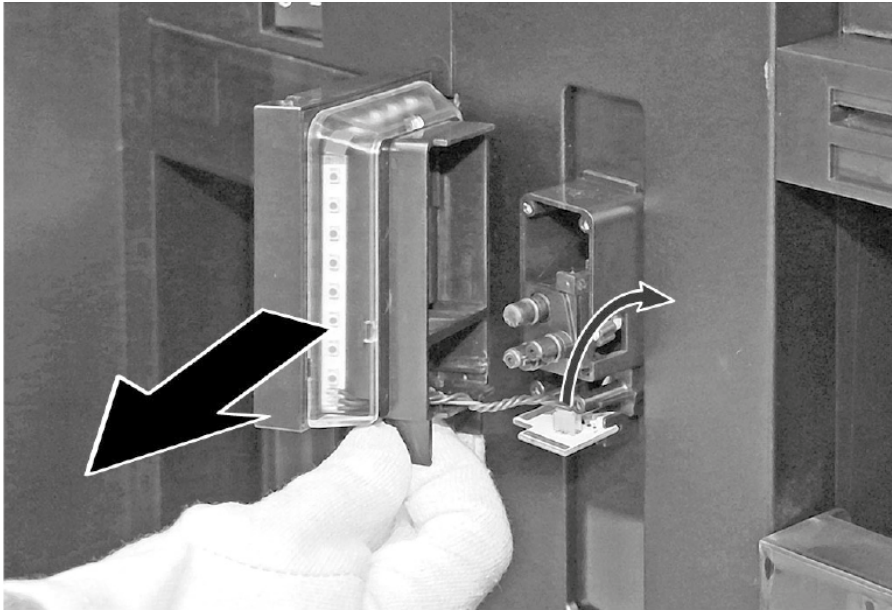

5. Húzza le a kiadótartó keretet, válassza le az elektromos csatlakozót, és távolítsa el a kiadótartó keretét.



- ➔ Eltávolította az italkifolyó-tartó keret hátsó burkolatát a csészevilágítással és a megvilágítással.

Consigli di riparazione - Macchina automatica per espresso

 Utilizzo del documento	99
1.1 Avvertenze importanti	99
1.1.1 Scopo	99
1.2 Spiegazione dei simboli	99
1.2.1 Livelli di pericolo	99
1.2.2 Simboli di pericolo	99
1.2.3 Struttura degli avvertimenti	100
1.2.4 Simboli generici	100
 Sicurezza	101
2.1 Note generali sulla sicurezza	101
2.1.1 Tutti gli elettrodomestici	101
 Strumenti e ausili	102
 Riparazione	103
4.1 Smontaggio del coperchio posteriore del telaio di supporto dell'erogatore be- vanda con illuminazione tazza e illuminazione generale	103

i Utilizzo del documento

1.1 Avvertenze importanti

1.1.1 Scopo

Queste istruzioni di riparazione spiegano ai clienti come riparare da soli gli elettrodomestici in conformità alle regole sull'Ecodesign vigenti (al 03/2021).

Contengono informazioni sulla sostituzione di pezzi di ricambio specifici e sulle avvertenze e i rischi correlati.

In caso di domande, contattare l'assistenza tecnica. Il mancato rispetto di tali istruzioni da parte dei clienti ci esonera da qualsiasi responsabilità.

1.2 Spiegazione dei simboli

1.2.1 Livelli di pericolo

I livelli di avvertimento corrispondono a un simbolo accompagnato da una parola di allerta. La parola di allerta identifica il livello di pericolo.





Livello di avvertimento	Significato
	Ignorare questo messaggio di avvertimento comporta rischio di morte o ferite gravi.
	Ignorare questo messaggio di avvertimento può comportare rischio di morte o ferite gravi.
	Ignorare questo messaggio di avvertimento può comportare ferite di minore gravità.
	Ignorare questo messaggio di avvertimento può comportare danni materiali.

Tabella 1: Livelli di pericolo

1.2.2 Simboli di pericolo

I simboli di pericolo sono illustrazioni che specificano la tipologia di rischio.

Nella presente documentazione vengono utilizzati i seguenti simboli di pericolo:

Simbolo di pericolo	Significato
	Messaggio di avvertimento generico
	Pericolo di scossa elettrica
	Pericolo di esplosione
	Rischio di ferite da taglio

i Utilizzo del documento





Simbolo di pericolo	Significato
	Pericolo di schiacciamento
	Pericolo derivante da superfici calde
	Pericolo derivante da forti campi magnetici
	Pericolo derivante da radiazioni non ionizzanti

Tabella 2: Simboli di pericolo

1.2.3 Struttura degli avvertimenti

Gli avvertimenti presenti in questo manuale hanno una forma e una struttura standardizzati.

	<p>PERICOLO</p> <p>Tipo e origine del pericolo! Possibili conseguenze in caso di pericolo/avvertimento ignorato.</p> <ul style="list-style-type: none"> ▸ Misure e divieti volti a prevenire il pericolo.
----------------------------------------------------------------------------------	--------------------------------------------------------------------------------------------------------------------------------------------------------------------------------------------------------------------------------------------

L'esempio seguente mostra un avvertimento con rischio di folgorazione dovuto a componenti sotto tensione. È riportata la misura di precauzione per evitare il pericolo.

	<p>PERICOLO</p> <p>Rischio di scossa elettrica dovuto a componenti sotto tensione! Morte per folgorazione</p> <ul style="list-style-type: none"> ▸ Scollegare l'apparecchio dall'alimentazione per almeno 60 secondi prima di iniziare la riparazione.
------------------------------------------------------------------------------------	-----------------------------------------------------------------------------------------------------------------------------------------------------------------------------------------------------------------------------------------------------------------------------------------

1.2.4 Simboli generici

Nel presente manuale vengono utilizzati i seguenti simboli generici:







Simbolo generico	Significato
	Identificazione di un suggerimento speciale (testo e/o grafica)
	Identificazione di un suggerimento semplice (solo testo)
	Identificazione di un link per un video tutorial
	Identificazione degli strumenti necessari
	Identificazione delle condizioni preve necessarie
	Identificazione di una condizione (se ..., allora ...)
	Identificazione di un risultato
[Avvio]	Identificazione di un tasto o di un pulsante
[00123456]	Identificazione di un codice articolo
Stato	Identificazione di un testo/finestra visualizzati (sul display dell'apparecchio)

Tabella 3: Simboli generici

2.1 Note generali sulla sicurezza

2.1.1 Tutti gli elettrodomestici

Rischio di scosse elettriche dovute a componenti sotto tensione!

- La riparazione non conforme dei componenti elettrici può causare scosse elettriche!
- Scollegare l'apparecchio dall'alimentazione per almeno 60 secondi prima di iniziare il lavoro.
- Ultimata la riparazione, occorre eseguire un test di sicurezza conforme alla norma VDE 0701 o alle norme specifiche del Paese.

Rischio di lesioni causate da bordi taglienti!

- Indossare guanti di protezione.

Rischio di schiacciamento dovuto a componenti pesanti e in movimento durante la riparazione, la manutenzione, la ricerca dei guasti e l'assistenza

- Indossare calzature antinfortunistiche.
- Fissare i componenti pesanti per impedire che cadano.
- Non inserire parti del corpo nei componenti in movimento.

Rischio per il funzionamento o la sicurezza dell'apparecchio!

- Utilizzare solo ricambi originali.

Rischio di danneggiamento di componenti sensibili a carica elettrostatica (ESD)!

- Non toccare i moduli, inclusi i collegamenti e le piste conduttive.

Strumenti e ausili

Designazione	Dettagli	Immagini
Punta Torx TX10 [00340864]	6,3 mm (1/4")	

4.1 Smontaggio del coperchio posteriore del telaio di supporto dell'erogatore bevanda con illuminazione tazza e illuminazione generale

Attrezzi speciali:

 Punta Torx TX10 6,3 mm (1/4") [00340864]

 L'apparecchio è dotato di luci LED esenti da manutenzione. Queste luci possono essere riparate esclusivamente dal servizio assistenza tecnica o da tecnici autorizzati!

 **PERICOLO**
Rischio di scosse elettriche dovute a componenti sotto tensione!
 Pericolo di morte dovuto a scosse elettriche in caso di riparazione non conforme

- ▶ Le parti elettriche devono essere riparate da elettricisti qualificati.
- ▶ Ultimata la riparazione, occorre eseguire un test di sicurezza conforme alla norma VDE 0701 o alle norme specifiche del Paese.

 **PERICOLO**
Rischio di scossa elettrica dovuto a componenti sotto tensione!
 Morte per folgorazione

- ▶ Scollegare l'apparecchio dall'alimentazione per almeno 60 secondi prima di iniziare la riparazione.

 **ATTENZIONE**
Bordi taglienti!
 Ferite da taglio

- ▶ Indossare guanti di protezione.

 **ATTENZIONE!**
Rischio di danneggiamento di componenti sensibili a carica elettrostatica (ESD)!
 Danneggiamento dei componenti

- ▶ Prima di toccare i componenti sensibili a carica elettrostatica, utilizzare un sistema di protezione dalle cariche elettrostatiche (bracciale con collegamento a terra).
- ▶ Non toccare i collegamenti e le piste conduttive dei moduli.
- ▶ Trasportare i componenti sensibili a carica elettrostatica solo in materiali conduttivi o imballaggi originali.
- ▶ Tenere i componenti sensibili a carica elettrostatica lontano da materiali a carica elettrostatica (ad es. plastica).

Prerequisiti:

-  L'apparecchio è scollegato dalla rete elettrica.
1. Aprire lo sportello frontale dell'apparecchio.

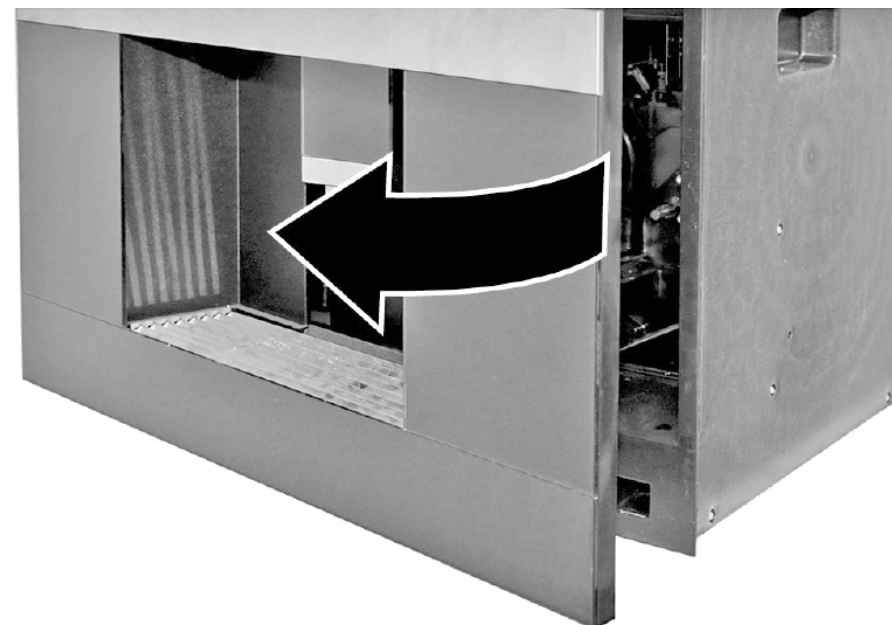

Riparazione

2. Estrarre e rimuovere il coperchio dell'erogatore bevanda.

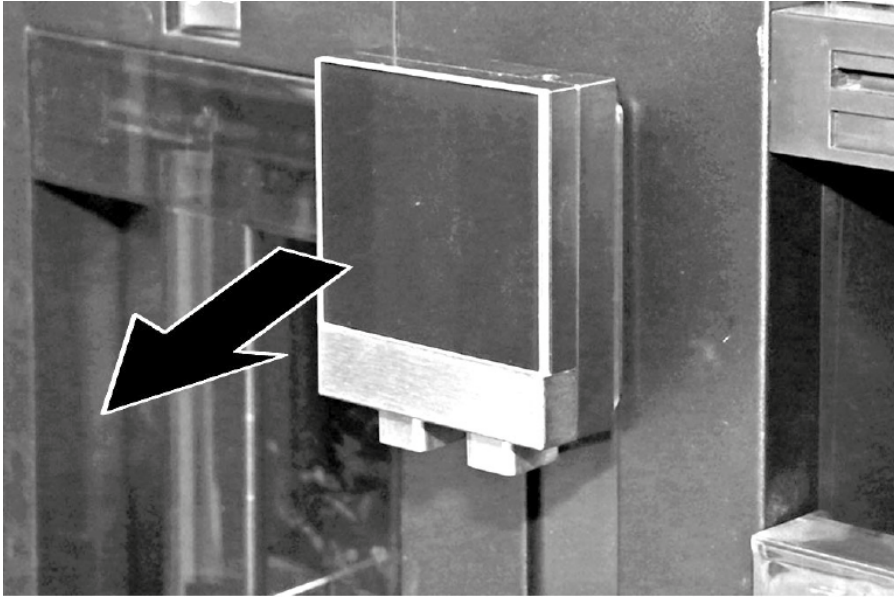

3. Estrarre e rimuovere il dispenser dell'erogatore bevanda.

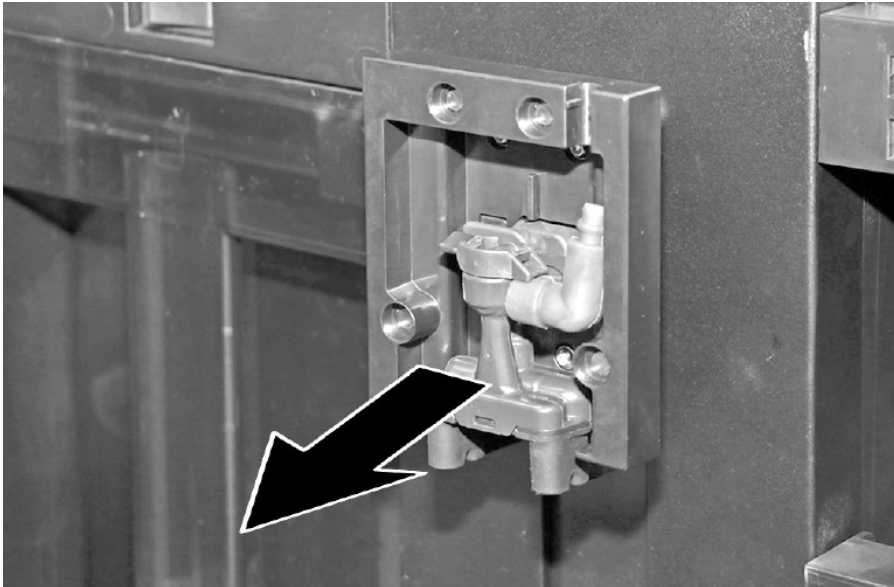

4. Svitare le quattro viti sul telaio di supporto dell'erogatore.

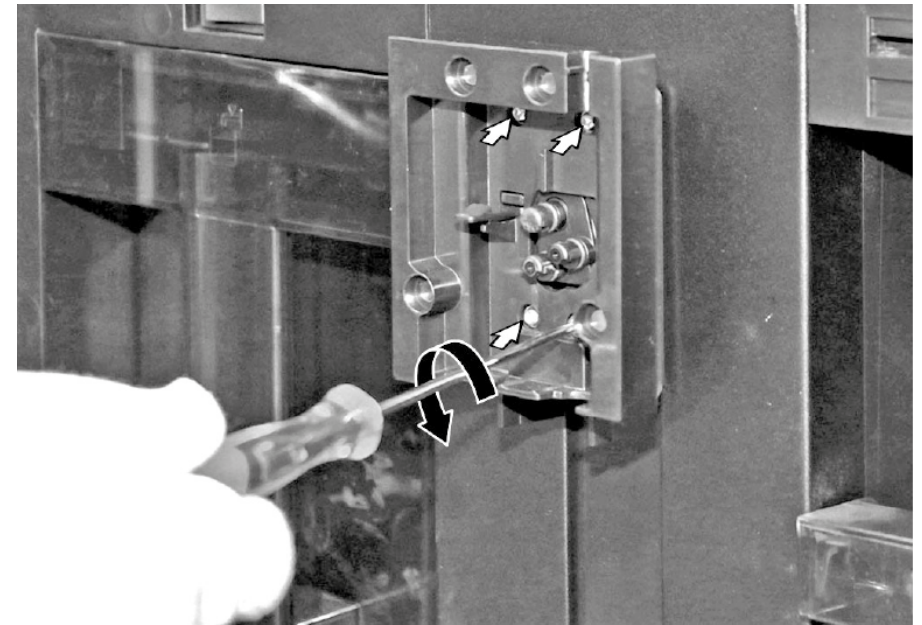



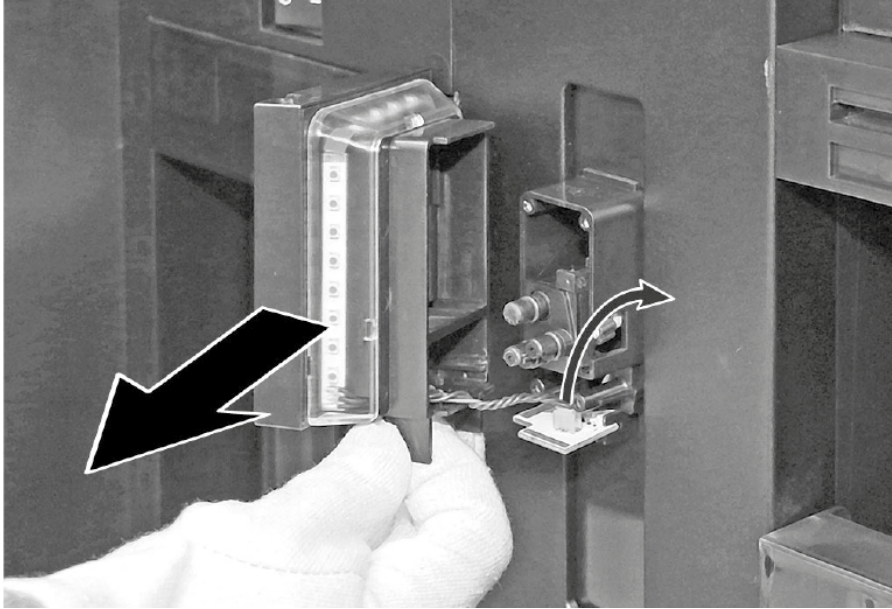

Riparazione

5. Estrarre il telaio di supporto dell'erogatore, scollegare il connettore elettrico e rimuovere il telaio di supporto dell'erogatore.



- ➡ Il coperchio posteriore del telaio di supporto dell'erogatore bevanda con l'illuminazione tazza e l'illuminazione generale è stato smontato.

Informācija par remontu - Fully automatic espresso machine

 Par šo dokumentu	107
1.1 Būtiska informācija	107
1.1.1 Mērķis	107
1.2 Simbolu skaidrojums.....	107
1.2.1 Bīstamības līmeņi	107
1.2.2 Bīstamības simboli	107
1.2.3 Brīdinājumu struktūra	108
1.2.4 Vispārīgie simboli.....	108
 Drošība	109
2.1 Vispārējie drošības norādījumi	109
2.1.1 Visām mājsaimniecības ierīcēm	109
 Piederumi un palīgīdzekļi	110
 Remonts	111
4.1 Dzēriena izvadīšanas atveres nesošā rāmja aizmugurējā pārsega, krūzes gaismekļa un dekoratīvā gaismekļa noņemšana	111

i Par šo dokumentu

1.1 Būtiska informācija

1.1.1 Mērķis

Šie labošanas ieteikumi ir paredzēti patērētājam, lai patstāvīgi labotu ierīces, saskaņā ar piemērojamo Ekodizaina regulu (sākot no 03.2021.).



Ir sniegta informācija, kā nomainīt noteiktas rezerves daļas, un brīdinājumi, kā arī ir aprakstīti riski.

Ja ir jautājumi, sazinieties ar mūsu klientu apkalpošanas dienestu. Mēs atbildam par zaudējumiem tikai tad, ja šie labošanas ieteikumi ir pienācīgi ievēroti.

1.2 Simbolu skaidrojums

1.2.1 Bīstamības līmeņi

Brīdinājuma līmeņus veido simbols un signālvārds. Signālvārds apzīmē bīstamības pakāpi.





Brīdinājuma līmenis	Nozīme
 BĪSTAMI	Brīdinājuma paziņojuma neievērošanas rezultātā iestāsies nāve vai radīsies smagas traumas.
 BRĪDINĀJUMS	Brīdinājuma paziņojuma neievērošanas rezultātā var iestāties nāve vai rasties smagas traumas.
 ESJET PIESARDŽĪGI	Brīdinājuma paziņojuma neievērošanas rezultātā var rasties nelielas traumas.
 UZMANĪBU!	Brīdinājuma paziņojuma neievērošanas rezultātā var rasties kaitējums īpašumam.

Tabula 1: Bīstamības līmeņi



1.2.2 Bīstamības simboli

Bīstamības simboli ir simboliski apzīmējumi, kas sniedz norādes par bīstamības veidu.

Šajā dokumentā ir izmantoti šādi bīstamības simboli:

Bīstamības simbols	Nozīme
	Vispārējs brīdinājuma paziņojums
	Elektriskā sprieguma radīts apdraudējums
	Sprādzienbīstamības risks
	Griezumu bīstamība
	Saspiešanas bīstamība

i Par šo dokumentu

Bīstamības simbols	Nozīme
	Karstu virsmu radīta bīstamība
	Spēcīgu magnētisko lauku radīta bīstamība
	Nejonizējoša starojuma radīta bīstamība

Tabula 2: Bīstamības simboli

1.2.3 Brīdinājumu struktūra

Šajā dokumentā sniegtajiem brīdinājumiem ir standartizēts noformējums un standartizēta struktūra.



	<p>⚠ BĪSTAMI</p> <p>Bīstamības veids un avots! Iespējamās sekas, kas rodas, neievērojot bīstamības paziņojumu / brīdinājumu.</p> <ul style="list-style-type: none"> ▶ Bīstamības novēršanas pasākumi un aizliegumi.
----------------------------------------------------------------------------------	------------------------------------------------------------------------------------------------------------------------------------------------------------------------------------------------------------------------------------------------------





Nākamajā piemērā ir parādīts brīdinājums, kas apzīmē elektrotrieciena risku, ko rada spriegumaktīvas detaļas. Ir norādīts bīstamības novēršanas pasākums.

	<p>⚠ BĪSTAMI</p> <p>Elektrotrieciena risks, ko rada spriegumaktīvas detaļas! Nāvējošs elektrotrieciens</p> <ul style="list-style-type: none"> ▶ Atvienojiet iekārtas no strāvas padeves vismaz 60 sekundes pirms labošanas sākšanas.
------------------------------------------------------------------------------------	-----------------------------------------------------------------------------------------------------------------------------------------------------------------------------------------------------------------------------------------------------------------------

1.2.4 Vispārīgie simboli

Šajā dokumentā ir izmantoti šādi vispārīgie simboli:

Visp. simbols	Nozīme
	Īpašu ieteikumu apzīmējums (teksts un/ vai grafika)
	Vienkāršu ieteikumu apzīmējums (tikai teksts)

Visp. simbols	Nozīme
	Video pamācības saites apzīmējums
	Nepieciešamo rīku apzīmējums
	Nepieciešamo priekšnosacījumu apzīmējums
	Nosacījuma apzīmējums (ja ..., tad ...)
	Rezultāta apzīmējums
[Sākt]	Taustiņa vai pogas apzīmējums
[00123456]	Materiāla numura apzīmējums
Statuss	Attēlotā teksta / loga apzīmējums (iekārtas displejā)

Tabula 3: Vispārīgie simboli

2.1 Vispārējie drošības norādījumi

2.1.1 Visām mājsaimniecības ierīcēm

Elektrotrieciena risks spriegumaktīvu daļu dēļ!

- Ja remonts, kas skar elektriskās daļas, ir veikts kļūdaini, pastāv elektrotrieciena risks!
- Ierīcei ir jābūt atvienotai no tīkla vismaz 60 sekundes, pirms sāk darbu.
- Pēc remonta ierīces drošība ir jāpārbauda atbilstīgi noteikumiem VDE 0701 vai valsts noteikumiem.

Savainojumu risks asu malu dēļ!

- Valkājiet aizsargcimdus.

Saspiešanas risks labošanas, uzturēšanas, traucējumu novēršanas un apkopes laikā, ko rada smagas un kustīgas detaļas

- Valkājiet aizsargapavus.
- Nostipriniet smagas detaļas, lai tās nenokristu.
- Neievietojiet ķermeņa daļas kustīgās detaļās.

Ierīces drošības / darbības traucējuma risks!

- Izmantojiet tikai oriģinālās rezerves daļas.

Pret elektrostatisko izlādi jutīgu daļu (ESDS) bojājuma risks!

- Neaiztieciet moduļus, ieskaitot savienojumus un vadojumu.

Piederumi un palīglīdzekļi

Apzīmējums	Sīkāka informācija	Attēli
Torx uzgalis TX10 [00340864]	6,3 mm (1/4")	

4.1 Dzēriena izvadīšanas atveres nesošā rāmja aizmugurējā pārsega, krūzes gaismekļa un dekoratīvā gaismekļa noņemšana

Speciāli rīki:

Torx uzgalis TX10 6,3 mm (1/4") [00340864]



Ierīcē ir LED gaismeklis, kam nav jāveic apkope.
Šo gaismekli drīkst remontēt tikai klientu apkalpošanas dienesta pārstāvis vai pilnvarots tehniķis!



BĪSTAMI

Elektrotrieciena risks spriegumaktīvu daļu dēļ!

Dzīvības apdraudējums nepareiza remonta izraisīta elektrotrieciena dēļ

- ▶ Elektriskās daļas ir jāremontē kvalificētam elektriķim.
- ▶ Pēc remonta ierīces drošība ir jāpārbauda atbilstīgi noteikumiem VDE 0701 vai valsts noteikumiem.



BĪSTAMI

Elektrotrieciena risks, ko rada spriegumaktīvas detaļas!

Nāvējošs elektrotrieciens

- ▶ Atvienojiet iekārtas no strāvas padeves vismaz 60 sekundes pirms labošanas sākšanas.



ESIET PIESARDZĪGI

Asas malas!

Grieztas brūces

- ▶ Lietojiet aizsargcimdus.



UZMANĪBU!

Pret elektrostatisko izlādi jutīgu daļu (ESD) bojājuma risks!

Daļu bojājumi

- ▶ Lai darbotos ar ESD, izmantojiet elektrostatiskās drošības elementu (aproci ar zemējumu).
- ▶ Nepieskarieties pie moduļu savienojumiem un vadojuma.
- ▶ Transportējiet ESD tikai vadītspējīgos materiālos vai oriģinālajā iepakojumā.
- ▶ Novērsiet, ka ESD tuvumā ir materiāli, kas var elektrostatiski uzlādēties (piemēram, plastmasa).

Prasība:

- ✓ Ierīcei ir jābūt atvienotai no strāvas padeves.
1. Atveriet ierīces priekšējās durvis.

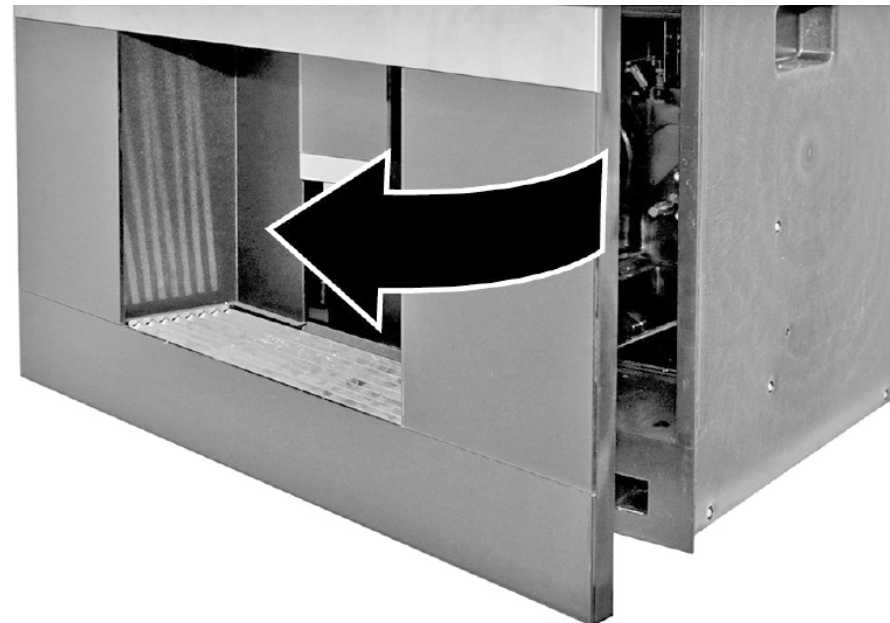

2. Novelciet un noņemiet dzēriena izvadīšanas atveres pārsegu.

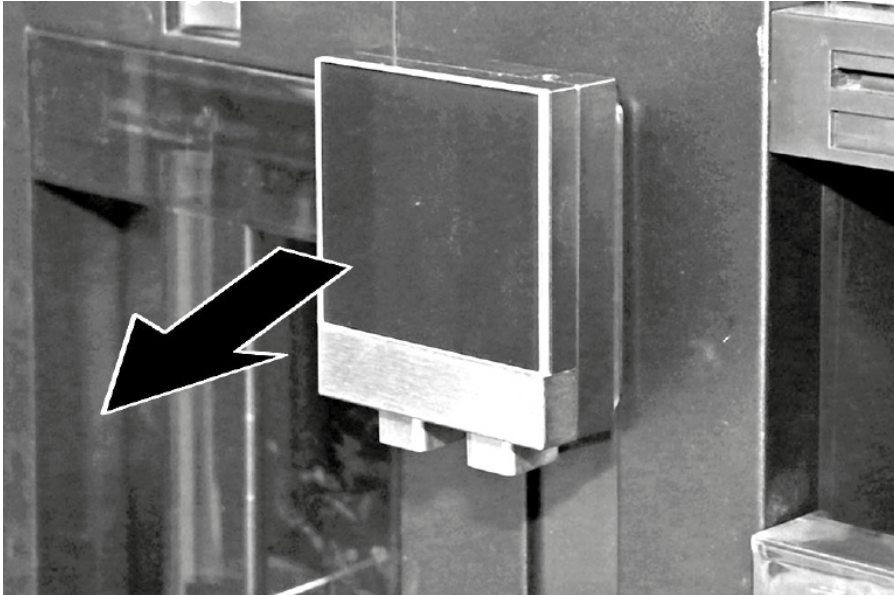

3. Izvelciet un noņemiet dzēriena izvadīšanas atveres dozatoru.

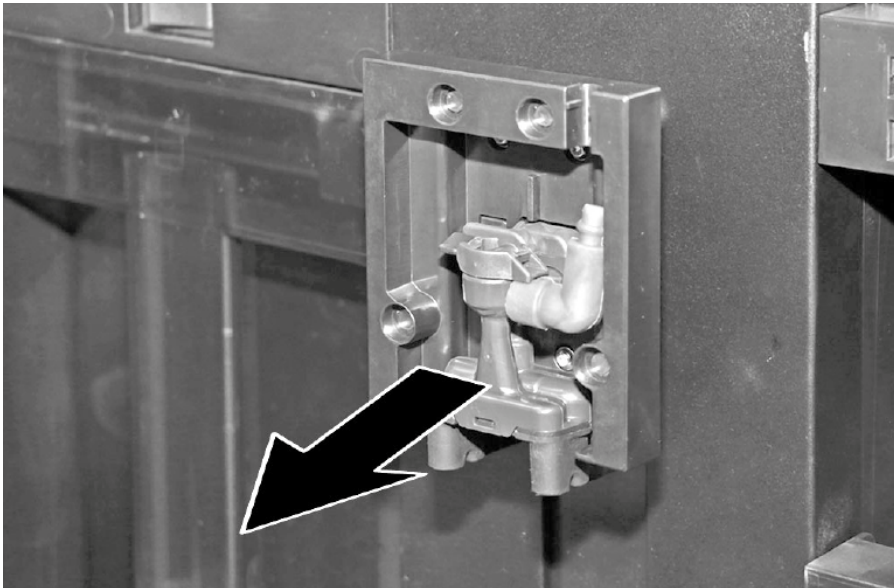

4. Izskrūvējiet izvadīšanas atveres nesošā rāmja četras skrūves.

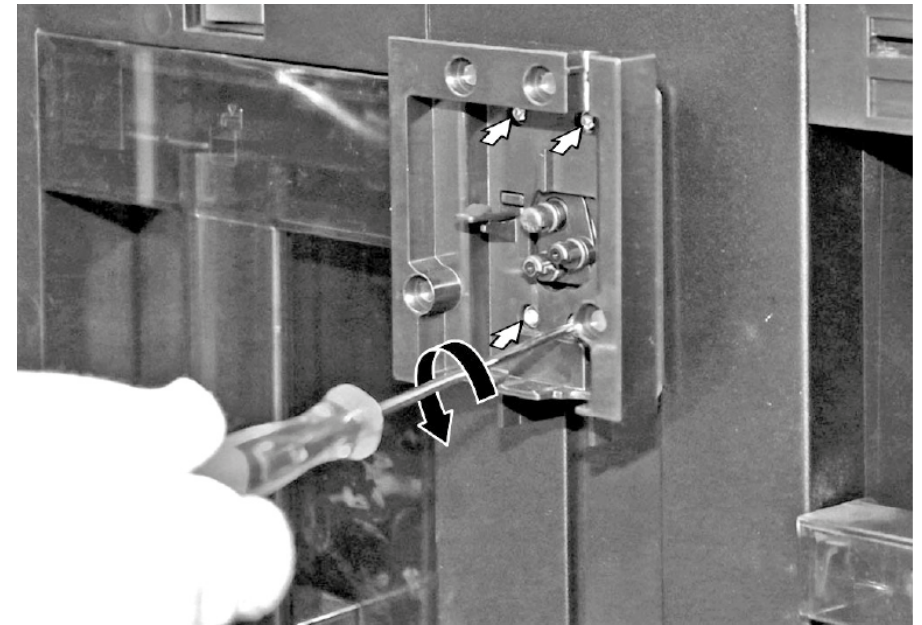



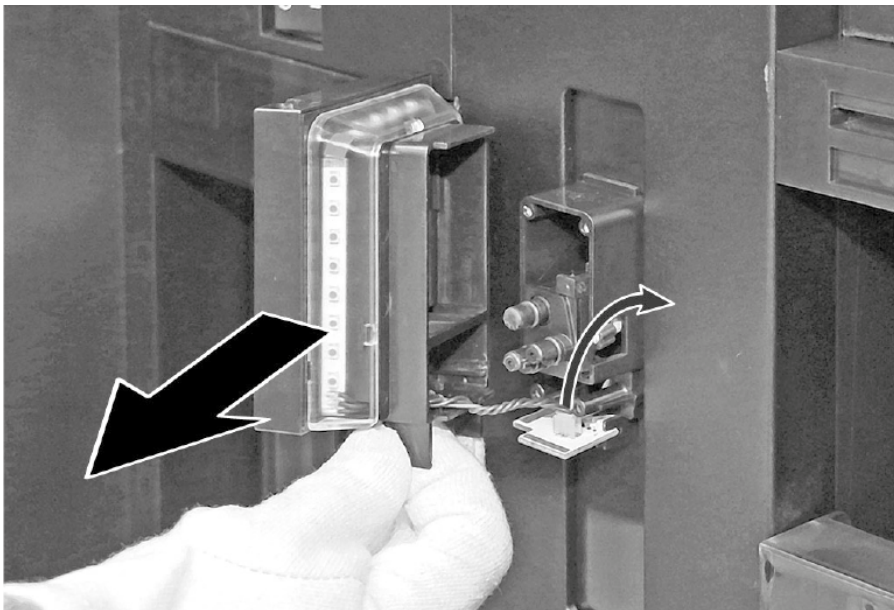

5. Novelciet izvadīšanas atveres nesošo rāmi, atvienojiet elektrosavienojumu, tad noņemiet izvadīšanas atveres nesošo rāmi.



- ➔ Dzēriena izvadīšanas atveres nesošā rāmja aizmugurējais pārsegs, krūzes gaismeklis un dekoratīvais gaismeklis ir noņemti.

Informacija apie remontą - Fully automatic espresso machine

 Dėl šio dokumento	115
1.1 Svarbi informacija	115
1.1.1 Paskirtis	115
1.2 Simbolių paaiškinimas	115
1.2.1 Pavojaus lygiai.....	115
1.2.2 Pavojaus simboliai	115
1.2.3 Įspėjimų struktūra.....	116
1.2.4 Bendrieji simboliai	116
 Sauga	117
2.1 Bendrosios saugos instrukcijos.....	117
2.1.1 Visi buitiniai prietaisai	117
 Įrankiai ir pagalbinės priemonės	118
 Remontas	119
4.1 Gėrimo išleidimo įtaiso atraminio rėmelio užpakalinės uždangos su puodelio lempute ir platformos apšvietimu išėmimas	119

i Dėl šio dokumento

1.1 Svarbi informacija

1.1.1 Paskirtis

Šios remonto nuorodos padeda naudotojui pataisyti prietaisus patiems pagal galiojantį ekologinio projektavimo reglamentą (2021 m. kovo mėn. redakcija).

Jose pateikta informacija, kaip pakeisti tam tikras atsargines dalis, įskaitant ir įspėjimus bei riziką.

Jei kiltų klausimų, kreipkitės į mūsų klientų aptarnavimo tarnybą. Mes atsakysime už žalą tik tuo atveju, jei bus tinkamai laikomasi remonto nuorodų.

1.2 Simbolių paaiškinimas

1.2.1 Pavojaus lygiai

Įspėjimo lygiai susideda iš simbolio ir signalinio žodžio. Signalinis žodis nurodo pavojaus sunkumą.





Įspėjimo lygis	Reikšmė
 PAVOJUS	Nepaisant įspėjamojo pranešimo, ištinka mirtis arba sunkūs sužalojimai.
 ĮSPĖJIMAS	Nepaisant įspėjamojo pranešimo, gali ištikti mirtis arba sunkūs sužalojimai.
 PERSPĖJIMAS	Nepaisant įspėjamojo pranešimo, galimi nedideli sužalojimai.
DĖMESIO!	Nepaisant įspėjamojo pranešimo, gali būti sugadintas turtas.

Lentelė 1: Pavojaus lygiai



1.2.2 Pavojaus simboliai

Pavojaus simboliai yra simboliniai atvaizdai, nurodantys pavojaus rūšį.

Šiame: dokumente naudojami tokie pavojaus simboliai

Pavojaus simbolis	Reikšmė
	Bendras įspėjamasis pranešimas
	Pavojinga elektros įtampa
	Sprogimo pavojus
	Įpjovimo pavojus
	Prispaudimo pavojus

i Dėl šio dokumento

Pavojaus simbolis	Reikšmė
	Pavojus dėl karštų paviršių
	Pavojus dėl stipraus magnetinio lauko
	Pavojus dėl nejonizuojančiosios spinduliuotės

Lentelė 2: Pavojaus simboliai

1.2.3 Įspėjimų struktūra

Šiame dokumente pateikiami įspėjimai yra standartizuotos išvaizdos ir standartizuotos struktūros.



	<p>⚠ PAVOJUS</p> <p>Pavojaus tipas ir šaltinis! Galimos pasekmės, jei nepaisoma pavojaus / įspėjimo.</p> <ul style="list-style-type: none"> ▶ Priemonės ir draudimai pavojui išvengti.
----------------------------------------------------------------------------------	-------------------------------------------------------------------------------------------------------------------------------------------------------------------------------------------------------------------------





Šiame pavyzdyje parodytas įspėjimas, įspėjantis apie elektros smūgį dėl dalių su įtampa. Paminėta priemonė, kaip išvengti pavojaus.

	<p>⚠ PAVOJUS</p> <p>Elektros smūgio pavojus dėl dalių, kuriose yra įtampa! Mirtis dėl elektros smūgio</p> <ul style="list-style-type: none"> ▶ Prieš pradėdami remontą, ne mažiau kaip prieš 60 sekundžių atjunkite prietaisus nuo elektros tiekimo.
-----------------------------------------------------------------------------------	---------------------------------------------------------------------------------------------------------------------------------------------------------------------------------------------------------------------------------------------------------------------------------------

1.2.4 Bendrieji simboliai

Šiame dokumente naudojami tokie bendrieji simboliai:

Bendr. simbolis	Reikšmė
	Žymi specialų patarimą (tekstas ir (arba) grafika)
	Žymi paprastą patarimą (tik tekstas)
	Žymi nuorodą į vaizdo pamoką

Bendr. simbolis	Reikšmė
	Žymi reikalingus įrankius
	Žymi reikalingas prielaidas
	Žymi sąlygą (jei ..., tai ...)
	Žymi rezultatą
[Paleisti]	Žymi klavišą arba ekrano mygtuką
[00123456]	Žymi dalies numerį
Būsena	Žymi rodomą tekstą / langą (prietaiso ekrane)

Lentelė 3: Bendrieji simboliai

2.1 Bendrosios saugos instrukcijos

2.1.1 Visi būtiniai prietaisai

Elektros smūgio pavojus dėl dalių, kuriose yra įtampa!

- Elektrinių konstrukcinių dalių remonto klaidos gali sukelti elektros smūgį!
- Prieš pradėdami dirbti, ne mažiau kaip prieš 60 sekundžių atjunkite prietaisą nuo maitinimo.
- Po remonto pasirūpinkite, kad būtų atliktas saugos bandymas pagal VDE 0701 arba šalyje galiojančius reglamentus.

Pavojus susižeisti į aštrias briaunas!

- Mūvėkite apsaugines pirštines.

Prispaudimo rizika remonto, einamosios techninės priežiūros, sutrikimų šalinimo ir techninės priežiūros metu dėl sunkių ir judančių konstrukcinių dalių

- Avėkite apsauginius batus.
- Apsaugokite sunkias konstrukcines dalis, kad jos nenukristų.
- Neartinkite kūno dalių prie judančių konstrukcinių dalių.

Rizika prietaiso saugai / veikimui!

- Naudokite tik originalias atsargines dalis.

Elektrostatškai jautrių konstrukcinių dalių (ESD) pažeidimo rizika!

- Nelieskite modulių, o taip pat ir jų jungčių bei laidininkų kelių.

Įrankiai ir pagalbinės priemonės

Paskyrimas	Išsami informacija	Vaizdai
„Torx“ antgalis TX10 [00340864]	6,3 mm (1/4")	

4.1 Gėrimo išleidimo įtaiso atraminio rėmelio užpakalinės uždangos su puodelio lempute ir platformos apšvietimu išėmimas

Specialūs įrankiai.

„Torx“ antgalis TX10 6,3 mm (1/4") [00340864]



Jūsų prietaise yra techninės priežiūros nereikalaujanti LED lemputė. Šias lemputes gali pataisyti tik klientų aptarnavimo tarnybos specialistai arba įgalioti technikai!



⚠ PAVOJUS

Elektros smūgio pavojus dėl dalių, kuriose yra įtampa!

Pavojus gyvybei dėl elektros smūgio netinkamo remonto atveju

- ▶ Elektrines dalis remontuoti turi kvalifikuoti elektrikai.
- ▶ Po remonto pasirūpinkite, kad būtų atliktas saugos bandymas pagal VDE 0701 arba šalyje galiojančius reglamentus.



⚠ PAVOJUS

Elektros smūgio pavojus dėl dalių, kuriose yra įtampa!

Mirtis dėl elektros smūgio

- ▶ Prieš pradėdami remontą, ne mažiau kaip prieš 60 sekundžių atjunkite prietaisus nuo elektros tiekimo.



⚠ PERSPĖJIMAS

Aštrios briaunos!

Galima įsipjauti

- ▶ Mūvėkite apsaugines pirštines.



DĖMESIO!

Elektrostatškai jautrių konstrukcinių dalių (ESD) pažeidimo rizika!

Konstrukcinių dalių pažeidimas

- ▶ Prieš liesdami ESD dalis užsidėkite elektrostatinės apsaugos sistemą (apyrankę su įžeminimo kištuku).
- ▶ Nelieskite modulių jungčių bei laidininkų kelių.
- ▶ ESD dalis transportuokite tik laidžiose medžiagose arba originalioje pakuotėje.
- ▶ Neartinkite ESD dalių prie elektrostatškai įsikraunančių medžiagų (pvz., plastikų).

Reikalavimas.

- ✔ Prietaisas atjungtas nuo maitinimo šaltinio.
1. Atidarykite priekines prietaiso dureles.

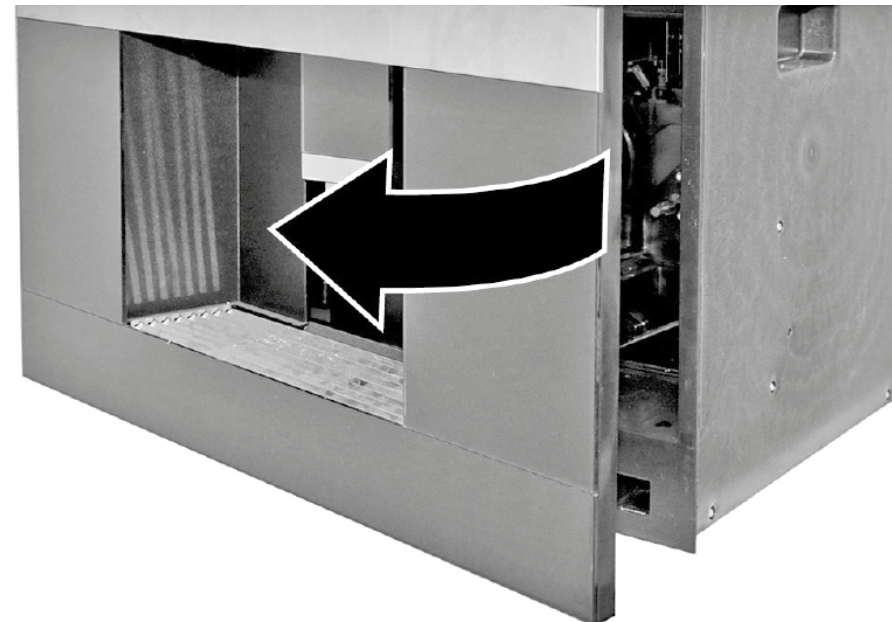

2. Patraukite ir nuimkite gėrimų išleidimo įtaiso uždangą.

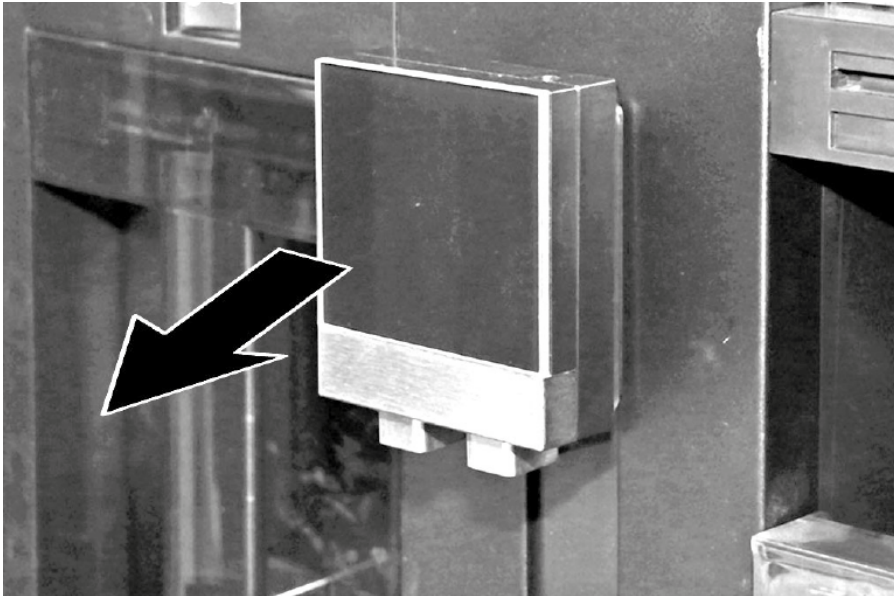

3. Ištraukite ir nuimkite gėrimų išleidimo įtaiso dalytuvą.

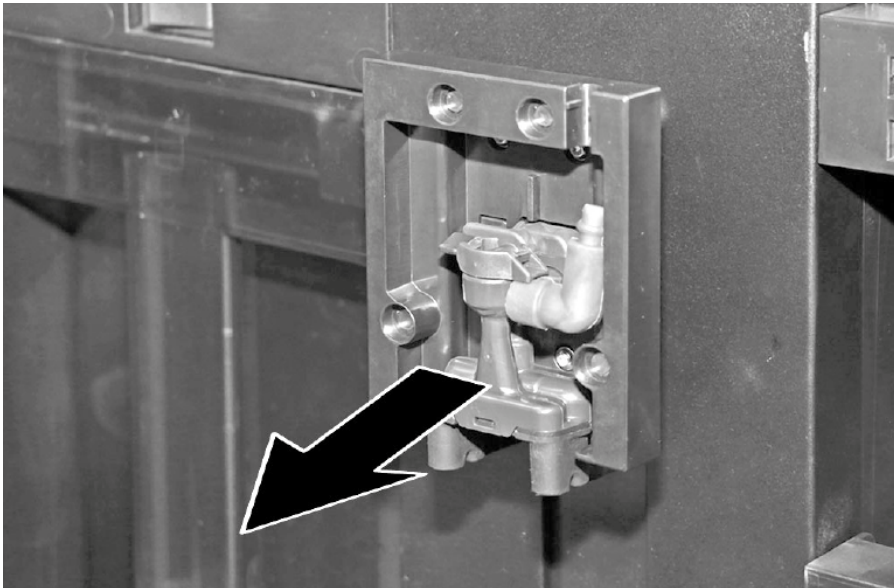

4. Išsukite keturis varžtus, esančius atraminiame išleidimo įtaiso rėmelyje.

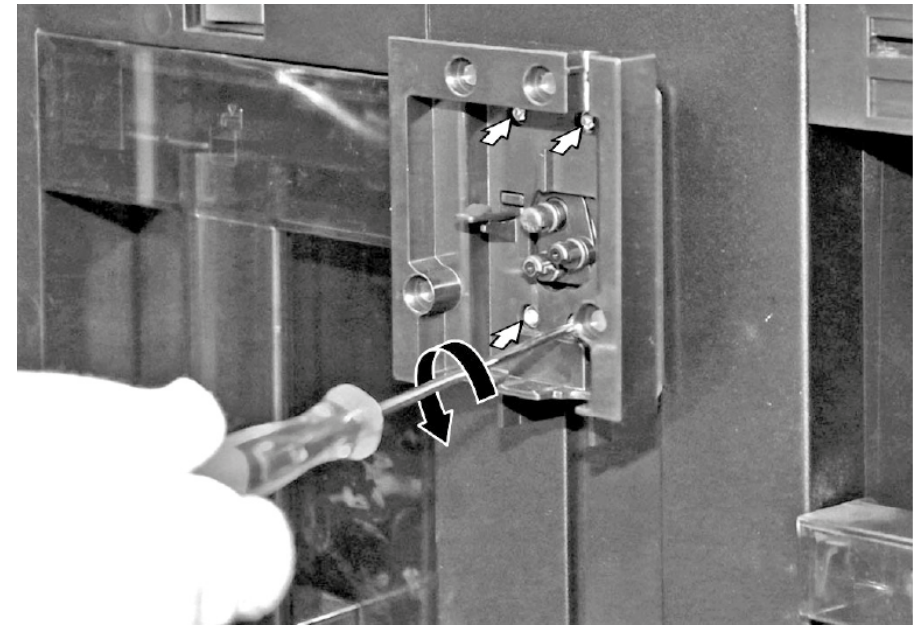

5. Ištraukite atraminį išleidimo įtaiso rėmelį, atjunkite elektros jungtis ir išimkite atraminį išleidimo įtaiso rėmelį.

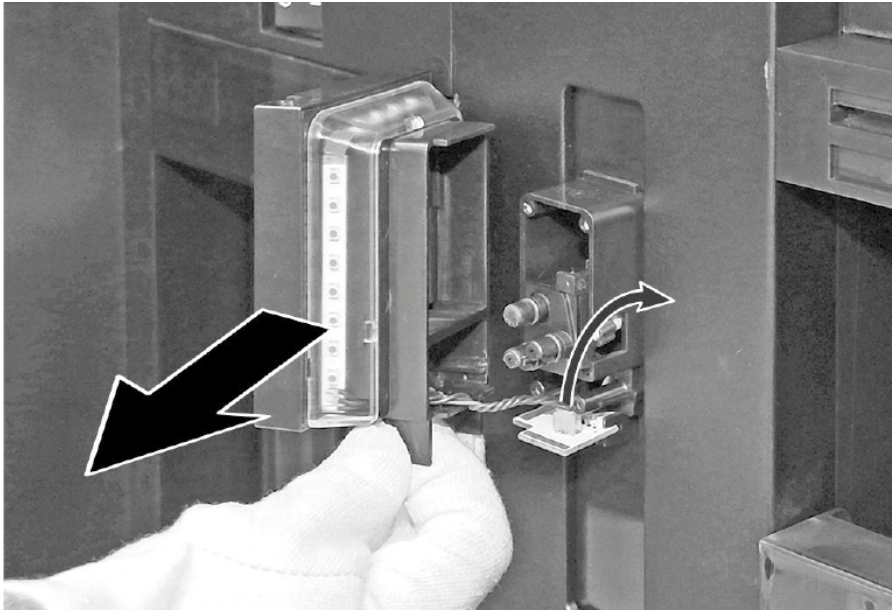

- ➡ Gėrimo išleidimo įtaiso atraminio rėmelio užpakalinė uždangas su puodelio lempute ir platformos apšvietimu išimta.

Reparasjonstips - Kaffeautomat

 Om dette dokumentet	123
1.1 Viktig informasjon	123
1.1.1 Formål.....	123
1.2 Forklaring av symboler.....	123
1.2.1 Farenivåer	123
1.2.2 Faresymboler.....	123
1.2.3 Advarslenes struktur	124
1.2.4 Generelle symboler	124
 Sikkerhet	125
2.1 Generelle sikkerhetsinstruksjoner	125
2.1.1 Alle husholdningsapparater	125
 Verktøy og hjelpemidler	126
 Reparasjon	127
4.1 Fjerning av bakdekselet på støtterammen for drikkeutløpet med lampe mot koppen og hyllebelysning	127

i Om dette dokumentet

1.1 Viktig informasjon

1.1.1 Formål

Disse tipsene om reparasjon skal hjelpe kunden til selv å kunne reparere apparater i samsvar med gjeldende regulering av øko-design (med gyldighet 03/2021).





De inneholder informasjon om hvordan definerte reservedeler skiftes, inklusive advarsler og risikoer.

Kontakt vår kundeservice dersom du har spørsmål. Vi påtar oss kun ansvar for skader dersom tipsene om reparasjon er korrekt fulgt.

1.2 Forklaring av symboler

1.2.1 Farenivåer

Advarslene som viser farenivå, består av et symbol og et signalord. Signalordet viser hvor alvorlig faren er.





Advarsel som viser farenivå	Betydning
 FARE	Dersom advarselen ignoreres, vil det føre til død eller alvorlige personskader.
 ADVARSEL	Dersom advarselen ignoreres, kan det føre til død eller alvorlige personskader.
 FORSIKTIG	Dersom advarselen ignoreres, kan det føre til mindre personskader.
 OBS!	Dersom advarselen ignoreres, kan det føre til materiell skade.

Tabell 1: Farenivåer



1.2.2 Faresymboler

Faresymboler er symbolske fremstillinger som gir en indikasjon av hvilken type fare det dreier seg om.

Følgende faresymboler brukes i dette dokumentet:

Faresymbol	Betydning
	Generell advarsel
	Fare for elektrisk støt
	Eksplisjonsfare
	Fare for å skjære seg
	Klemfare



i Om dette dokumentet

Faresymbol	Betydning
	Fare på grunn av varme overflater
	Fare på grunn av sterkt magnetfelt
	Fare fra ikke-ioniserende stråling



Tabell 2: Faresymboler

1.2.3 Advarslenes struktur

Advarslene i dette dokumentet har standardisert utseende og standardisert struktur.



	 Faretype og kilde til fare! Mulige konsekvenser dersom fare/advarsel ignoreres. <ul style="list-style-type: none">▶ Tiltak og forbud for å forebygge fare.
----------------------------------------------------------------------------------	-------------------------------------------------------------------------------------------------------------------------------------------------------------------------------------------------------------------------------------------------------------------------







Eksemplet nedenfor viser en advarsel mot elektrisk støt på grunn av strømførende deler. Tiltaket for å unngå faren er angitt.

	 Fare for elektrisk støt på grunn av strømførende deler! Død på grunn av drepende elektrisk støt <ul style="list-style-type: none">▶ Koble apparatene fra strømforsyningen i minst 60 sekunder før reparasjonene startes.
-----------------------------------------------------------------------------------	---------------------------------------------------------------------------------------------------------------------------------------------------------------------------------------------------------------------------------------------------------------------------------------------------------------------------------------

1.2.4 Generelle symboler

Følgende generelle symboler brukes i dette dokumentet:

Gen. symbol	Betydning
	Identifisering av et spesielt tips (tekst og/eller grafikk)
	Identifisering av et enkelt tips (kun tekst)
	Identifisering av en lenke til en opplæringsvideo

Gen. symbol	Betydning
	Identifisering av nødvendig verktøy
	Identifisering av nødvendige forutsetninger
	Identifisering av en betingelse (hvis ..., så ...)
	Identifisering av et resultat
	Identifisering av en tast eller knapp
	Identifisering av et materialnummer
	Identifisering av vist tekst/vindu (i apparatets display)

Tabell 3: Generelle symboler

2.1 Generelle sikkerhetsinstruksjoner

2.1.1 Alle husholdningsapparater

Fare for elektrisk støt på grunn av strømførende deler!

- Feil ved reparasjoner hvor elektriske komponenter er involvert, kan føre til elektrisk støt!
- Koble apparatet fra strømmettet i minst 60 sekunder før arbeidet startes.
- Etter reparasjonen må du sørge for at det utføres en sikkerhetstest iht. VDE 0701 eller gjeldende forskrifter i det respektive land.

Fare for personskade på grunn av skarpe kanter!

- Bruk vernehansker.

Fare for å knuse legemsdeler under reparasjoner, vedlikehold, feilsøking og service på grunn av tunge og bevegelige komponenter

- Bruk vernesko.
- Sikre tunge komponenter for å hindre at de faller ned.
- Ikke stikk kroppsdelene inn i bevegelige komponenter.

Fare for apparatets sikkerhet/funksjon!

- Bruk kun originale reservedeler.

Fare for skade på deler som er følsomme overfor elektrostatisk utlading (ESD)!

- Ikke berør modulene, inklusive tilkoblinger og ledere.

Verktøy og hjelpemidler

Betegnelse	Detaljer	Bilder
Torx-bits TX10 [00340864]	6,3 mm (1/4")	

Reparasjon

4.1 Fjerning av bakdekselet på støtterammen for drikkeutløpet med lampe mot koppen og hyllebelysning

Spesielle hjelpemidler:

 Torx-bits TX10 6,3 mm (1/4") [00340864]

 Apparatet har en vedlikeholdsfri LED-lampe.
Disse lampene skal kun repareres av kundeservice eller autoriserte teknikere!

 **FARE**
Fare for elektrisk støt på grunn av strømførende deler!
Livsfare på grunn av elektrisk støt ved feil reparasjon

- ▶ Elektriske deler skal repareres av kvalifiserte elektrikere.
- ▶ Etter reparasjonen må du sørge for at det utføres en sikkerhetstest iht. VDE 0701 eller gjeldende forskrifter i det respektive land.

 **FARE**
Fare for elektrisk støt på grunn av strømførende deler!
Død på grunn av drepende elektrisk støt

- ▶ Koble apparatene fra strømforsyningen i minst 60 sekunder før reparasjonene startes.

 **FORSIKTIG**
Skarpe kanter!
Kuttskader

- ▶ Bruk vernehansker.

 **OBS!**
Fare for skade på deler som er følsomme overfor elektrostatisk utlading (ESD)!
Skader på komponenter

- ▶ Før du berører ESD-er må du bruke et beskyttelsessystem mot elektrostatisk utlading (jordingsarmbånd).
- ▶ Ikke berør tilkoblingene og lederbanene for modulene.
- ▶ ESD-er må bare transporteres i ledende materialer eller originalemballasje.
- ▶ Hold ESD-er unna elektrostatisk oppladbare materialer (f.eks. plast).

Forutsetning:

-  Apparatet kobles fra strømforsyningen.
1. Åpne fordøren på apparatet.

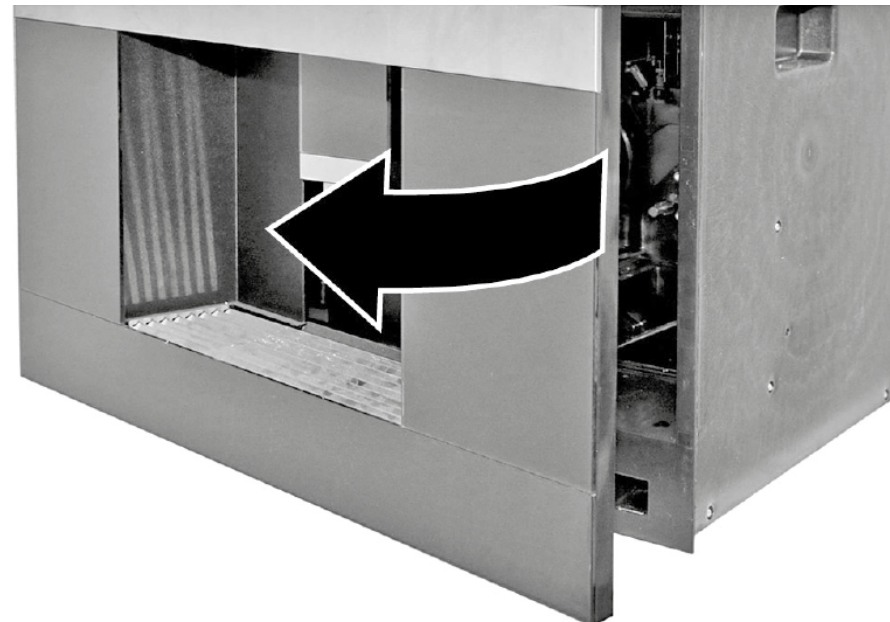

Reparasjon

2. Trekk av og fjern dekselet på drikkeutløpet.

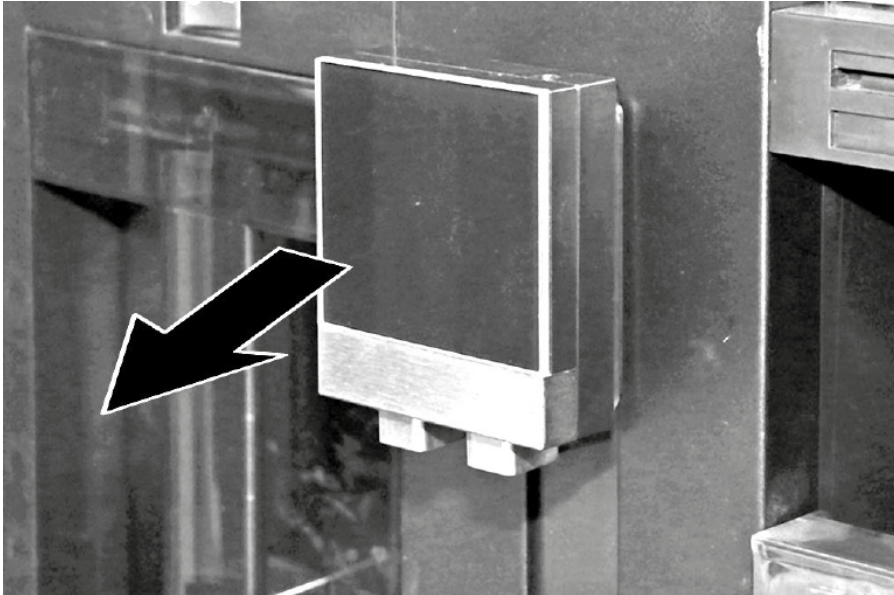

3. Trekk ut og fjern dispenserens for drikkeutløpet.

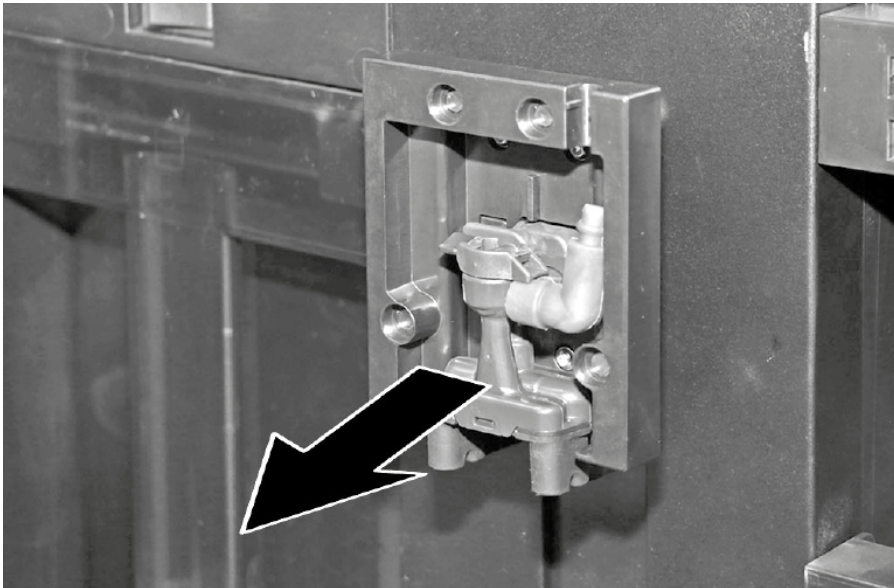

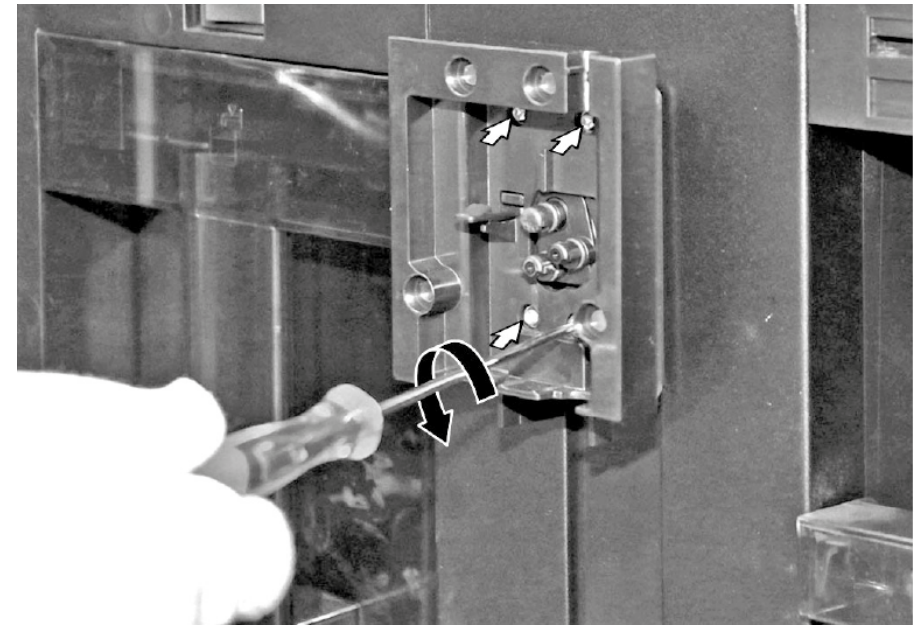

4. Skru løs fire skruer på støtterammen for utløpet.





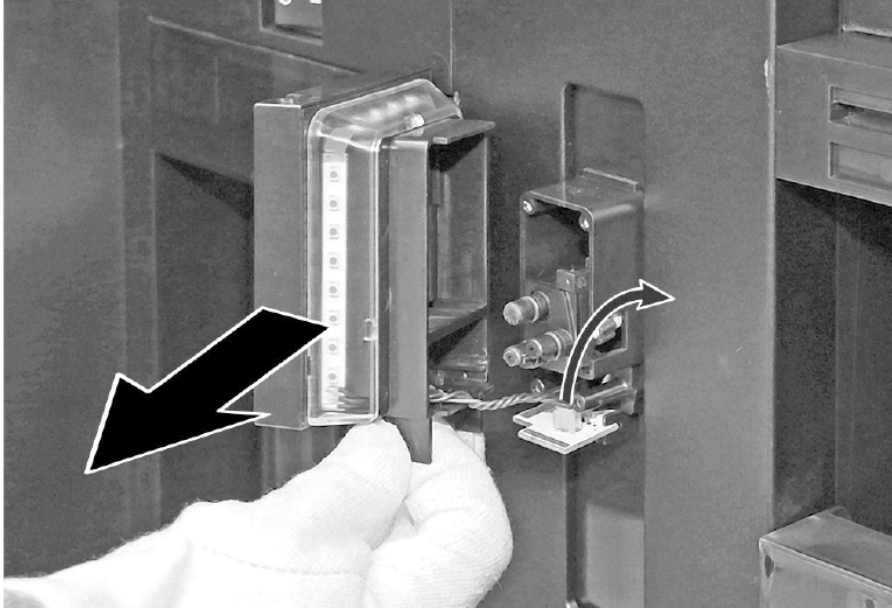

Reparasjon

5. Trekk av støtterammen for utløpet, koble fra strømpluggen og fjern støtterammen for utløpet.



-  Bakdekselet på støtterammen for drikkeutløpet med lampe mot koppen og hyllebelysning, er demontert.

Wskazówki naprawy - Ekspres do kawy

 Informacje dotyczące dokumentu	131
1.1 Ważne informacje.....	131
1.1.1 Cel dokumentu	131
1.2 Objasnienie symboli ostrzegawczych.....	131
1.2.1 Oznaczenie poziomów niebezpieczeństwa	131
1.2.2 Symbole ostrzegawcze.....	131
1.2.3 Budowa ostrzeżeń	132
1.2.4 Ogólne symbole.....	132
 Bezpieczeństwo	133
2.1 Ogólne informacje dotyczące bezpieczeństwa.....	133
2.1.1 Wszystkie sprzęty gospodarstwa domowego	133
 Narzędzia i pomoce techniczne	134
 Naprawy	135
4.1 Demontaż tylnej pokrywy ramki mocującej wylotu napojów z oświetleniem kubka i elementem oświetleniowym	135

i Informacje dotyczące dokumentu

1.1 Ważne informacje

1.1.1 Cel dokumentu

Niniejsze wskazówki naprawcze mają na celu zapewnienie użytkownikowi pomocy w samodzielnej naprawie posiadanych urządzeń w sposób zgodny z obowiązującymi przepisami w sprawie ekoprojektu (stan na 03/2021).

Zawierają one informacje na temat wymiany określonych części zamiennych oraz ostrzeżenia i informacje o zagrożeniach.

W razie pytań należy się skontaktować z naszym działem serwisowym. Odpowiedzialność za szkody ponosimy tylko pod warunkiem prawidłowego stosowania się do wskazówek naprawczych.

1.2 Objasnienie symboli ostrzegawczych

1.2.1 Oznaczenie poziomów niebezpieczeństwa

Poziom ryzyka jest określany przy pomocy symbolu oraz wyrazu. Wyraz określa poziom ryzyka.



Symbol	Znaczenie
 NIEBEZPIECZEŃSTWO	Bezpośrednio zagrażające niebezpieczeństwo, które przy niezachowaniu odpowiednich środków ostrożności może doprowadzić do śmierci lub poważnych obrażeń.
 OSTRZEŻENIE	Prawdopodobieństwo wystąpienia niebezpieczeństwa, które przy niezachowaniu odpowiednich środków ostrożności może doprowadzić do śmierci lub poważnych obrażeń.
 WAŻNE	Prawdopodobieństwo wystąpienia niebezpieczeństwa, które przy niezachowaniu odpowiednich środków ostrożności może doprowadzić do powstania lekkich obrażeń.
UWAGA!	Ostrzeżenie dot. możliwości powstania szkody materialnej.

Tabela 1: Oznaczenie poziomów niebezpieczeństwa

1.2.2 Symbole ostrzegawcze

Symbole ostrzegawcze reprezentują graficznie źródło potencjalnego ryzyka.

W poniższym dokumencie użyto następujących symboli:

Symbole ostrzegawcze	Znaczenie
	Ogólne ostrzeżenie
	Niebezpieczeństwo od napięcia elektrycznego
	Ryzyko wybuchu

i Informacje dotyczące dokumentu







Symbole ostrzegawcze	Znaczenie
	Ryzyko obrażeń (rozcięć)
	Ryzyko zmiążdżenia
	Ryzyko oparzenia
	Silne pole magnetyczne
	Promieniowanie nie-jonizujące

Tabela 2: Symbole ostrzegawcze

1.2.3 Budowa ostrzeżeń

Ostrzeżenia podane w dokumencie mają standardową budowę.

	<p>NIEBEZPIECZEŃSTWO</p> <p>Typ i źródło ryzyka!! Konsekwencje zignorowania.</p> <ul style="list-style-type: none"> ▶ Środki ochronne.
-----------------------------------------------------------------------------------	-------------------------------------------------------------------------------------------------------------------------------------------------------------------------

Kolejne ostrzeżenie wskazuje, jako źródło możliwość porażenia prądem. Wskazano czynności, które mają za zadanie ograniczenie ryzyka.

	<p>NIEBEZPIECZEŃSTWO</p> <p>Ryzyko porażenia prądem, ze względu na elementy będące pod napięciem! Zagrożenie życia poprzez porażenie prądem</p> <ul style="list-style-type: none"> ▶ Odłączyć urządzenie od zasilania sieciowego na 60 sekund przed rozpoczęciem naprawy.
------------------------------------------------------------------------------------	------------------------------------------------------------------------------------------------------------------------------------------------------------------------------------------------------------------------------------------------------------------------------------------------------------

1.2.4 Ogólne symbole

Poniższe symbole są używane w dokumentacji:







Symbol	Znaczenie
	Identyfikacja specjalnej wskazówki (tekst lub grafika)
	Identyfikacja prostej wskazówki (tylko tekst)
	Identyfikacja linku do pliku wideo
	Identyfikacja narzędzi
	Identyfikacja wstępnych warunków
	Identyfikacja warunku (jeżeli)
	Identyfikacja rezultatu
[Start]	Identyfikacja przycisku
[00123456]	Identyfikacja numeru materiału
Status	Identyfikacja wyświetlanego tekstu / komunikatu (na wyświetlaczu)

Tabela 3: Ogólne symbole

2.1 Ogólne informacje dotyczące bezpieczeństwa

2.1.1 Wszystkie sprzęty gospodarstwa domowego

Ryzyko porażenia prądem elektrycznym wskutek kontaktu z elementami znajdującymi się pod napięciem!

- Błędna naprawa części elektrycznych może spowodować porażenie prądem elektrycznym!
- Co najmniej 60 sekund przed przystąpieniem do pracy odłączyć urządzenie od sieci elektrycznej.
- Po naprawie należy przeprowadzić test bezpieczeństwa zgodny z przepisami normy VDE 0701 (Niemcy) lub odpowiednimi przepisami obowiązującymi w kraju użytkowania.

Ryzyko zranienia o ostre krawędzie!

- Używać rękawic ochronnych.

Ryzyko zmiżdżenia podczas naprawy, obsługi lub diagnozy, ze względu na ciężkie i ruchome elementy

- Stosować obuwie ochronne.
- Zabezpieczyć ciężkie elementy przed upadkiem.
- Nie dotykać ruchomych elementów podczas pracy urządzenia.

Zagrożenie dla bezpieczeństwa użytkownika i działania urządzenia!

- Używać tylko oryginalnych części zamiennych.

Ryzyko uszkodzenia komponentów wrażliwych na wyładowania elektrostatyczne (ESD)!

- Nie dotykać modułów, włącznie ze złączami i ścieżkami przewodzącymi.

Narzędzia i pomoce techniczne

Przeznaczenie	Detale	Zdjęcia
Torx-Bit TX10 [00340864]	6,3 mm (1/4")	

4.1 Demontaż tylnej pokrywy ramki mocującej wylotu napojów z oświetleniem kubka i elementem oświetleniowym

Pomoce specjalne

 Torx-Bit TX10 6,3 mm (1/4") [00340864]

 Urządzenie posiada bezobsługowe oświetlenie LED. Tego rodzaju elementy oświetleniowe mogą być naprawiane wyłącznie przez serwis lub autoryzowanych techników!

 **NIEBEZPIECZEŃSTWO**
Ryzyko porażenia prądem elektrycznym wskutek kontaktu z elementami znajdującymi się pod napięciem!
 Niebezpieczeństwo utraty życia wskutek porażenia prądem elektrycznym w przypadku nieprawidłowej naprawy

- ▶ Części elektryczne powinny być naprawiane przez wykwalifikowanych elektryków.
- ▶ Po naprawie należy przeprowadzić test bezpieczeństwa zgodny z przepisami normy VDE 0701 (Niemcy) lub odpowiednimi przepisami obowiązującymi w kraju użytkowania.

 **NIEBEZPIECZEŃSTWO**
Ryzyko porażenia prądem, ze względu na elementy będące pod napięciem!
 Zagrożenie życia poprzez porażenie prądem

- ▶ Odłączyć urządzenie od zasilania sieciowego na 60 sekund przed rozpoczęciem naprawy.

 **WAŻNE**
Ostre krawędzie!
 Rany cięte

- ▶ Zawsze używaj rękawic ochronnych.

 **UWAGA!**
Ryzyko uszkodzenia komponentów wrażliwych na wyładowania elektrostatyczne (ESD)!
 Uszkodzenie komponentów

- ▶ Przed dotknięciem komponentów wrażliwych na wyładowania elektrostatyczne (ESD) podłączyć system ochrony elektrostatycznej (opaska z wtyczką uziemiającą).
- ▶ Nie dotykać połączeń i ścieżek przewodzących na modułach.
- ▶ Komponenty wrażliwe na wyładowania elektrostatyczne (ESD) transportować wyłącznie w materiałach przewodzących lub oryginalnym opakowaniu.
- ▶ Komponenty wrażliwe na wyładowania elektrostatyczne (ESD) trzymać z dala od materiałów ładujących się elektrostatycznie (np. plastik).

Warunek:

-  Urządzenie odłączone od źródła zasilania.
1. Otworzyć przednie drzwiczki urządzenia.

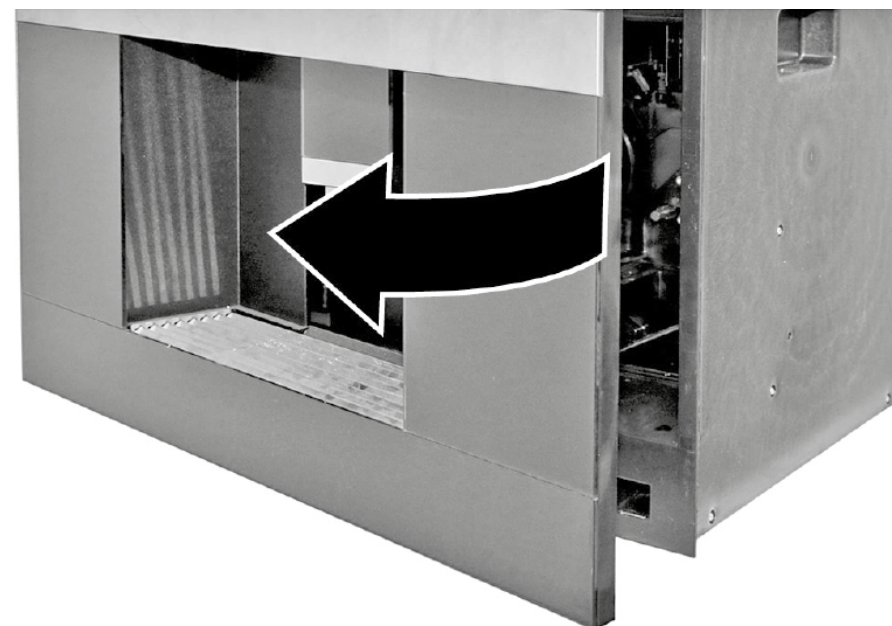

2. Wyciągnąć i wyjąć pokrywę wylotu napojów.

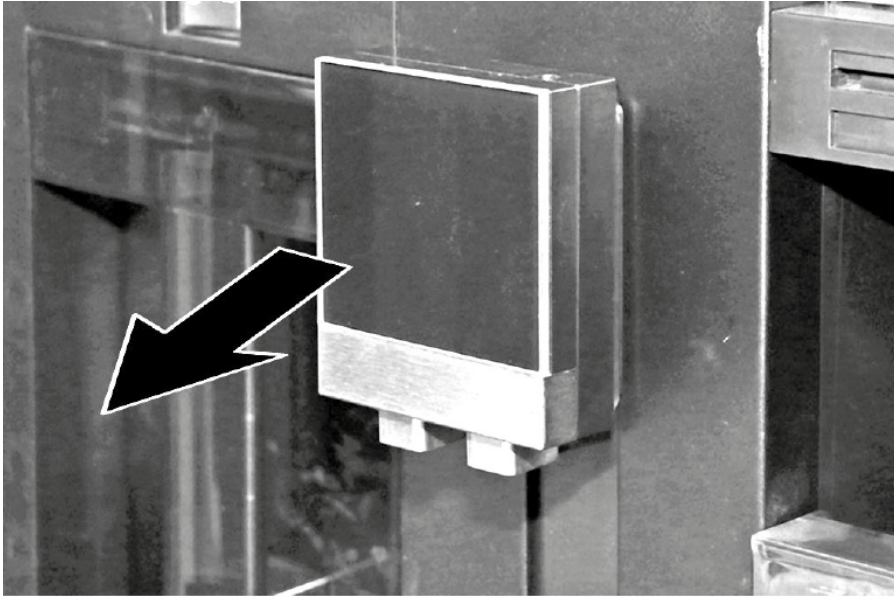

3. Wyciągnąć i wyjąć dystrybutor wylotu napojów.

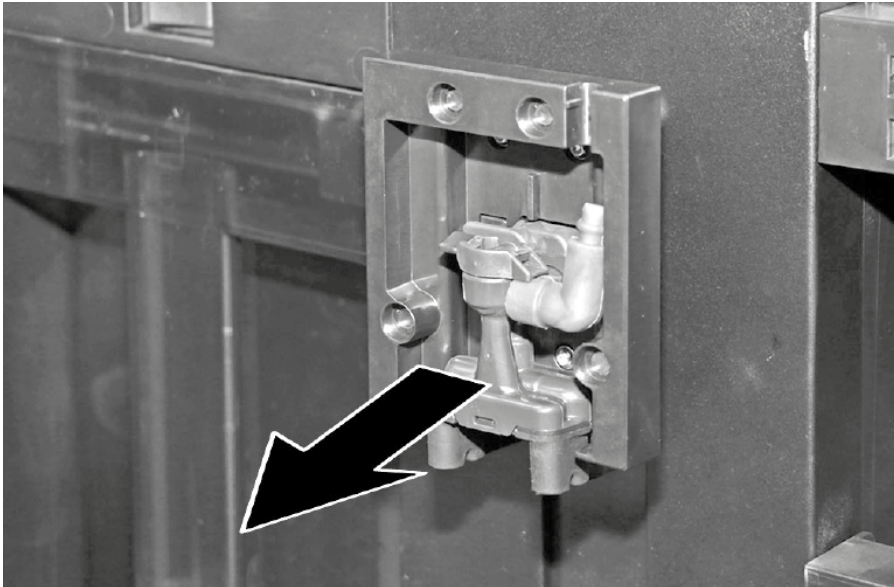

4. Odkręcić cztery wkręty ramki mocującej wylotu.

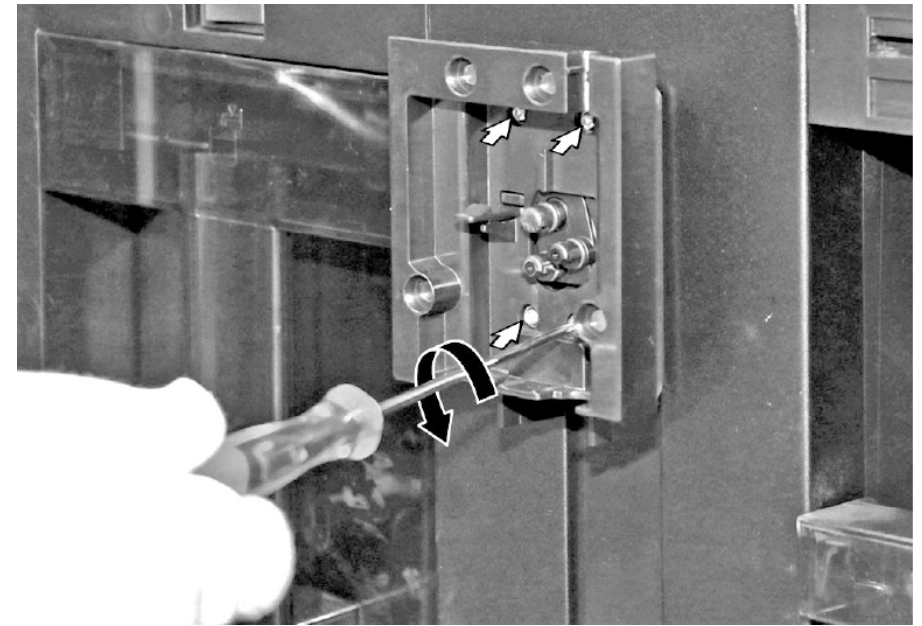



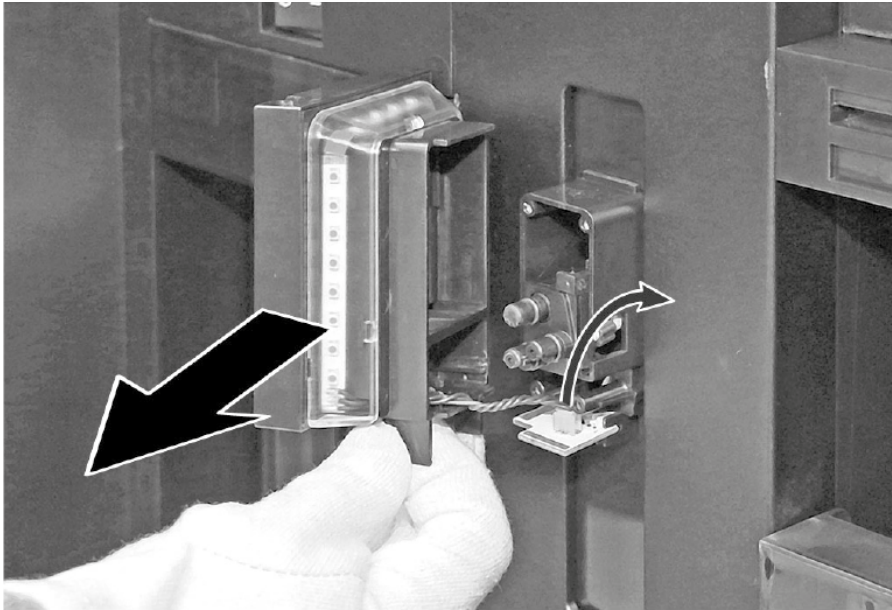

Naprawy

5. Zdjąć ramkę mocującą wylotu, odłączyć złącze elektryczne i wyjąć ramkę mocującą wylotu.



- ➡ Tylna pokrywa ramki mocującej wylotu napojów z oświetleniem kubka i elementem oświetleniowym została wymontowana.

Dicas de resolução - Máquina de café

 Sobre este documento	139
1.1 Informação importante	139
1.1.1 Finalidade.....	139
1.2 Explicação dos símbolos.....	139
1.2.1 Níveis de perigo.....	139
1.2.2 Símbolos de perigo	139
1.2.3 Estrutura dos avisos.....	140
1.2.4 Símbolos gerais	140
 Segurança	141
2.1 Instruções gerais de segurança.....	141
2.1.1 Todos os eletrodomésticos	141
 Ferramentas e auxiliares	142
 Reparação	143
4.1 Remover a cobertura traseira da armação de apoio da saída de bebidas com iluminação do copos e iluminação de estado	143

i Sobre este documento

1.1 Informação importante

1.1.1 Finalidade

Estas dicas de reparação auxiliam o consumidor na reparação de aparelhos por ele próprio de acordo com o regulamento de "Eco-design" aplicável (a partir de 03/2021).

Estas contêm informações sobre como substituir peças sobressalentes definidas, incluindo avisos e riscos.

Em caso de dúvidas, entre em contacto com o nosso serviço de apoio ao cliente. Apenas nos responsabilizaremos por danos se as dicas de reparação tiverem sido devidamente seguidas.

1.2 Explicação dos símbolos

1.2.1 Níveis de perigo

Os níveis de aviso são compostos por um símbolo e uma palavra sinal. A palavra-sinal indica a gravidade do perigo.





Nível de aviso	Significado
 PERIGO	A não observância da mensagem de aviso resulta em morte ou ferimentos graves.
 AVISO	A não observância da mensagem de aviso pode resultar em morte ou ferimentos graves.
 CUIDADO	A não observância da mensagem de aviso pode resultar em ferimentos ligeiros.
ATENÇÃO!	A não observância da mensagem de aviso pode resultar em danos materiais.

Tabela 1: Níveis de perigo

1.2.2 Símbolos de perigo

Os símbolos de perigo são representações simbólicas que dão uma indicação do tipo de perigo.

Neste documento são utilizados os seguintes símbolos de perigo:

Símbolo de perigo	Significado
	Mensagem geral de aviso
	Perigo de tensão elétrica
	Risco de explosão
	Perigo de cortes

i Sobre este documento





Símbolo de perigo	Significado
	Perigo de esmagamento
	Perigo de superfícies quentes
	Perigo de campo eletromagnético intenso
	Perigo de radiação não-ionizante

Tabela 2: Símbolos de perigo

1.2.3 Estrutura dos avisos

Os avisos neste documento possuem um aspeto normalizado e uma estrutura normalizada.

	<div style="background-color: red; color: white; padding: 2px; text-align: center;">⚠ PERIGO</div> <p>Tipo e origem do perigo! Possíveis consequência de ignorar o perigo / aviso.</p> <ul style="list-style-type: none"> ▶ Medidas e proibições para prevenir o perigo.
----------------------------------------------------------------------------------	-----------------------------------------------------------------------------------------------------------------------------------------------------------------------------------------------------------------------------------------------------------------------------------------------------------

O seguinte exemplo mostra um aviso que adverte contra choques elétricos devido a partes sob tensão. A medida para evitar o perigo é mencionada.

	<div style="background-color: red; color: white; padding: 2px; text-align: center;">⚠ PERIGO</div> <p>Risco de choque elétrico devido a partes sob tensão! Morte por eletrocussão</p> <ul style="list-style-type: none"> ▶ Desligue os aparelhos da alimentação elétrica pelo menos 60 segundos antes de iniciar as reparações.
------------------------------------------------------------------------------------	------------------------------------------------------------------------------------------------------------------------------------------------------------------------------------------------------------------------------------------------------------------------------------------------------------------------------------------------------------------

1.2.4 Símbolos gerais

Neste documento são utilizados os seguintes símbolos gerais:







Símbolo ger.	Significado
	Identificação de uma dica especial (texto e/ou ilustração)
	Identificação de uma dica simples (apenas texto)
	Identificação de uma ligação para um tutorial em vídeo
	Identificação das ferramentas necessárias
	Identificação das condições prévias necessárias
	Identificação de uma condição (se ..., então ...)
	Identificação de um resultado
Iniciar	Identificação de uma tecla ou botão
[00123456]	Identificação de um número de material
Estado	Identificação de um texto exibido / janela (no visor do aparelho)

Tabela 3: Símbolos gerais

2.1 Instruções gerais de segurança

2.1.1 Todos os eletrodomésticos

Risco de choque elétrico devido a partes sob tensão!

- Erros por reparações envolvendo componentes elétricos podem provocar choques elétricos!
- Desligue o aparelho da rede elétrica pelo menos 60 segundos antes de iniciar o trabalho.
- Após a reparação, solicite a realização de um teste de segurança de acordo com VDE 0701 ou os regulamentos específicos do país.

Risco de ferimentos causados por arestas vivas!

- Use luvas de proteção.

Risco de esmagamento durante trabalhos de reparação, manutenção, resolução de problemas e serviço devido a componentes pesados e móveis

- Use calçado de proteção.
- Proteja os componentes pesados contra quedas.
- Não introduzir partes do corpo em componentes móveis.

Risco para a segurança/funcionamento do aparelho!

- Utilize apenas peças sobressalentes originais.

Risco de danos em componentes electrostaticamente sensíveis (ESDs)!

- Não toque nos módulos, incluindo ligações e percursos condutores.

Ferramentas e auxiliares

Designação	Detalhes	Imagens
Ponta Torx TX10 [00340864]	6,3 mm (1/4")	

4.1 Remover a cobertura traseira da armação de apoio da saída de bebidas com iluminação do copos e iluminação de estado

Ferramentas necessárias:

 Ponta Torx TX10 6,3 mm (1/4") [00340864]



O seu aparelho dispõe de uma iluminação LED isenta de manutenção. Estas iluminações só podem ser reparadas pelo serviço de apoio ao consumidor ou por técnicos autorizados!



PERIGO

Risco de choque elétrico devido a partes sob tensão!
Risco de vida devido a choque elétrico em caso de reparação inadequada

- ▶ As partes elétricas devem ser reparadas por um electricista qualificado.
- ▶ Após a reparação, solicite a realização de um teste de segurança de acordo com VDE 0701 ou os regulamentos específicos do país.



PERIGO

Risco de choque elétrico devido a partes sob tensão!
Morte por eletrocussão

- ▶ Desligue os aparelhos da alimentação elétrica pelo menos 60 segundos antes de iniciar as reparações.



CUIDADO

Arestas vivas!
Lesões por corte

- ▶ Use luvas de proteção.



ATENÇÃO!

Risco de danos em componentes electrostaticamente sensíveis (ESDs)!

Danos nos componentes

- ▶ Antes de tocar em ESDs, usar um sistema de proteção eletrostático (pulseira com ficha de proteção de terra).
- ▶ Não toque em ligações e percursos condutores dos módulos.
- ▶ Apenas transporte os ESDs em materiais condutores ou na embalagem original.
- ▶ Mantenha os ESDs afastados dos materiais que possam ser carregados electrostaticamente (por exemplo: plástico).

Pré-requisito:

-  O aparelho está desligado da energia.
1. Abra a porta frontal do aparelho.

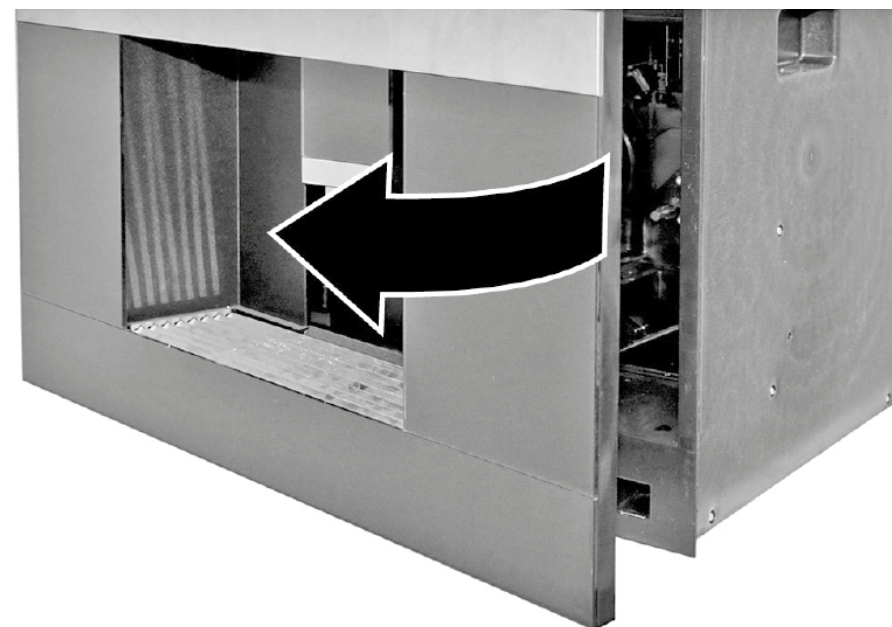

Reparação

2. Extraia e remova a cobertura da saída de bebidas.

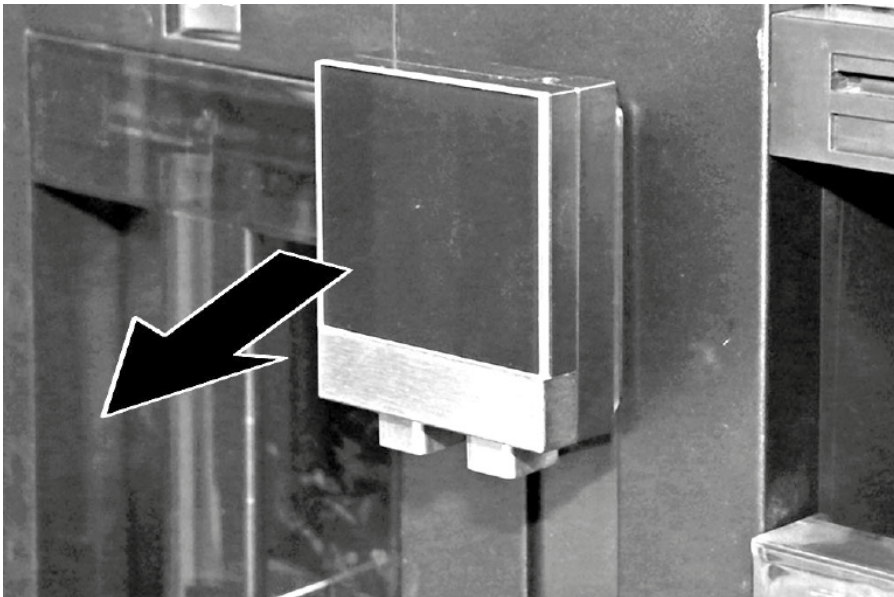

3. Extraia e remova o distribuidor da saída de bebidas.

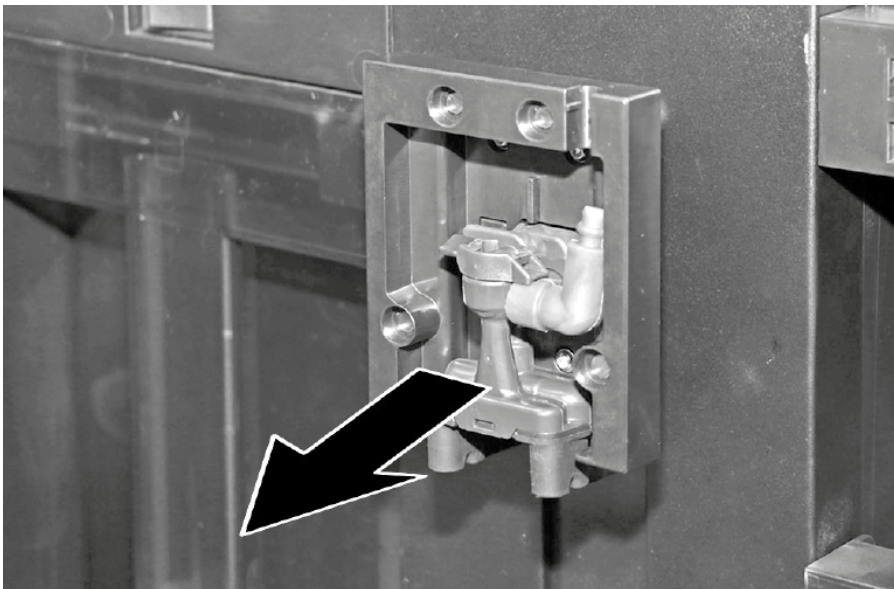

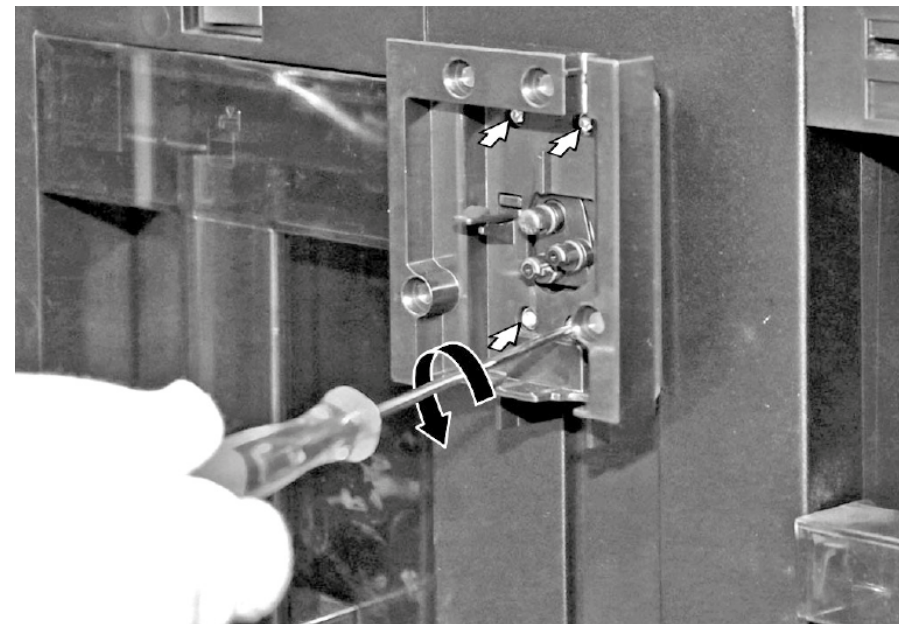

4. Desaperte quatro parafusos na armação de apoio da saída.





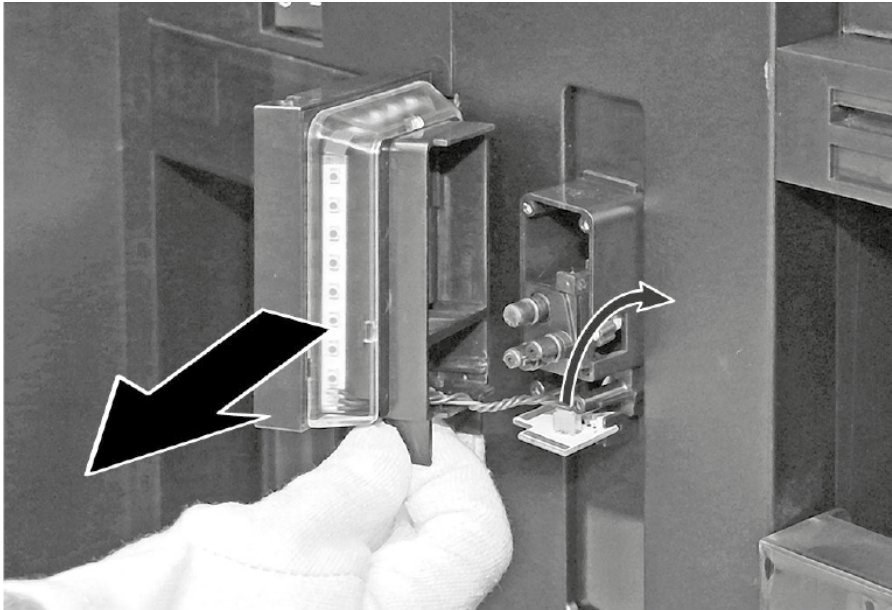

Reparação

5. Extraia a armação de apoio da saída, desligue o conector elétrico e remova a armação de apoio da saída.



-  A cobertura traseira da armação de apoio da saída de bebidas com iluminação dos copos e iluminação de estado está removida.

Indicii pentru reparații - Cafetieră

 Referitor la acest document.....	147
1.1 Informații importante	147
1.1.1 Aplicabilitatea	147
1.2 Explicația simbolurilor	147
1.2.1 Nivelurile de pericol.....	147
1.2.2 Simbolurile de pericol.....	147
1.2.3 Structura avertismentelor.....	148
1.2.4 Simbolurile generale	148
 Siguranța.....	149
2.1 Instrucțiuni generale de siguranță.....	149
2.1.1 Toate aparatele electrocasnice	149
 Instrumente și materiale utile.....	150
 Repararea.....	151
4.1 Demontarea capacului din spate al cadrului de susținere a dispozitivului cu orificiul de evacuare a băuturii cu lumină pentru pahar și sistem de iluminare..	151

i Referitor la acest document

1.1 Informații importante

1.1.1 Aplicabilitatea

Aceste instrucțiuni de reparare îl ajută pe client să își repare singur aparatele, în conformitate cu normele de proiectare ecologică aplicabile (începând cu 03/2021).





Acestea conțin informații privind modul de înlocuire a pieselor de schimb specifice, inclusiv avertismente și pericole.

Dacă aveți întrebări, vă rugăm să luați legătura cu serviciul relații clienți. Ne asumăm răspunderea pentru daune numai dacă instrucțiunile de reparare au fost respectate pe deplin.

1.2 Explicația simbolurilor

1.2.1 Nivelurile de pericol

Nivelurile de alertă sunt reprezentate printr-un simbol și un cuvânt de avertizare. Cuvântul de avertizare indică gravitatea pericolului.





Nivelul de alertă	Semnificație
 PERICOL	Nerespectarea mesajului de avertizare va provoca accidente grave sau decesul.
 AVERTISMENT	Nerespectarea mesajului de avertizare ar putea provoca accidente grave sau decesul.
 ATENȚIONARE	Nerespectarea mesajului de avertizare ar putea provoca accidente ușoare.
 ATENȚIE!	Nerespectarea mesajului de avertizare ar putea provoca daune asupra proprietății.

Tabel 1: Nivelurile de pericol



1.2.2 Simbolurile de pericol

Simbolurile de pericol sunt reprezentări simbolice care indică tipul de pericol.

În acest document sunt utilizate simbolurile de pericol de mai jos:

Simbol de pericol	Semnificație
	Mesaj de avertizare general
	Pericol din cauza tensiunii electrice
	Pericol de explozie
	Pericol de tăiere
	Pericol de zdrobire

i Referitor la acest document

Simbol de pericol	Semnificație
	Pericol din cauza suprafețelor fierbinți
	Pericol din cauza câmpului magnetic puternic
	Pericol din cauza radiației neionizante

Tabel 2: Simbolurile de pericol

1.2.3 Structura avertismentelor

Avertismentele din acest document au un aspect și o structură standard.



	<div style="background-color: red; color: white; padding: 2px; text-align: center;">⚠ PERICOL</div> <p>Tipul și sursa pericolului! Consecințele posibile ale ignorării pericolului/avertismentului.</p> <ul style="list-style-type: none"> ▶ Măsuri și interdicții pentru prevenirea pericolului.
----------------------------------------------------------------------------------	------------------------------------------------------------------------------------------------------------------------------------------------------------------------------------------------------------------------------------------------------------------------------------------------------------------------------------









Exemplul următor prezintă un avertisment privind electrocutarea din cauza pieselor sub tensiune. Se menționează măsura necesară pentru a evita pericolul.

	<div style="background-color: red; color: white; padding: 2px; text-align: center;">⚠ PERICOL</div> <p>Pericol de electrocutare din cauza pieselor sub tensiune! Deces prin electrocutare</p> <ul style="list-style-type: none"> ▶ Deconectați aparatele de la sursa de alimentare cu tensiune cu cel puțin 60 de secunde înainte de a începe reparațiile.
-----------------------------------------------------------------------------------	---------------------------------------------------------------------------------------------------------------------------------------------------------------------------------------------------------------------------------------------------------------------------------------------------------------------------------------------------------------------------------------------

1.2.4 Simbolurile generale

În acest document sunt utilizate simbolurile generale de mai jos:

Simbol general	Semnificație
	Identificarea unei recomandări speciale (text și/sau grafică)
	Identificarea unei recomandări simple (numai text)

Simbol general	Semnificație
	Identificarea unui link spre un videoclip instructiv
	Identificarea sculelor necesare
	Identificarea condițiilor preliminare necesare
	Identificarea unei stări (dacă..., apoi...)
	Identificarea unui rezultat
	Identificarea unei taste sau a unui buton
	Identificarea unui număr de serie
	Identificarea unui text/unei ferestre afișate (pe ecranul aparatului)

Tabel 3: Simbolurile generale

2.1 Instrucțiuni generale de siguranță

2.1.1 Toate aparatele electrocasnice

Pericol de electrocutare din cauza pieselor sub tensiune!

- Erorile care au loc în timpul reparațiilor efectuate la componentele electrice pot să ducă la electrocutări!
- Deconectați aparatul de la sursa de alimentare cu tensiune cu cel puțin 60 de secunde înainte de a începe lucrările.
- După reparație, este obligatorie efectuarea unei verificări de siguranță conform cu VDE 0701 sau cu reglementările naționale respective.

Pericol de rănire din cauza muchiilor ascuțite!

- Purtați mănuși de protecție.

Pericol de zdrobire în timpul lucrărilor de reparație, întreținere, depanare și service, din cauza componentelor grele și mobile

- Purtați încălțăminte de protecție.
- Fixați componentele grele împotriva căderii.
- Nu vă sprijiniți cu părți ale corpului de componentele mobile.

Pericol pentru siguranța/funcționarea aparatului!

- Utilizați numai piese de schimb originale.

Pericol de deteriorare a componentelor sensibile la electricitatea statică (ESD)!

- Nu atingeți modulele, inclusiv conexiunile și căile conductorilor.

Instrumente și materiale utile

Desemnare	Detalii	Imagini
Cap torx TX10 [00340864]	6,3 mm (1/4")	

Repararea

4.1 Demontarea capacului din spate al cadrului de susținere a dispozitivului cu orificiul de evacuare a băuturii cu lumină pentru pahar și sistem de iluminare

Scule speciale:

 Cap torx TX10 6,3 mm (1/4") [00340864]

	<p>Aparatul dumneavoastră este echipat cu o lampă LED care nu necesită întreținere.</p> <p>Aceste lămpi pot fi înlocuite numai de către departamentul de service pentru clienți sau de către tehnicieni autorizați!</p>
-----------------------------------------------------------------------------------	-------------------------------------------------------------------------------------------------------------------------------------------------------------------------------------------------------------------------

	<p>⚠ PERICOL</p> <p>Pericol de electrocutare din cauza pieselor sub tensiune! Pericol de moarte prin electrocutare în cazul unei reparații necorespunzătoare</p> <ul style="list-style-type: none">▶ Componentele electrice trebuie reparate de către electricieni calificați.▶ După reparație, este obligatorie efectuarea unei verificări de siguranță conform cu VDE 0701 sau cu reglementările naționale respective.
----------------------------------------------------------------------------------	-------------------------------------------------------------------------------------------------------------------------------------------------------------------------------------------------------------------------------------------------------------------------------------------------------------------------------------------------------------------------------------------------------------------------------------------------------------------

	<p>⚠ PERICOL</p> <p>Pericol de electrocutare din cauza pieselor sub tensiune! Deces prin electrocutare</p> <ul style="list-style-type: none">▶ Deconectați aparatele de la sursa de alimentare cu tensiune cu cel puțin 60 de secunde înainte de a începe reparațiile.
-----------------------------------------------------------------------------------	--------------------------------------------------------------------------------------------------------------------------------------------------------------------------------------------------------------------------------------------------------------------------------------------------------

	<p>⚠ ATENȚIONARE</p> <p>Marginea ascuțite! Rănire prin tăiere</p> <ul style="list-style-type: none">▶ Purtați mănuși de protecție.
------------------------------------------------------------------------------------	--------------------------------------------------------------------------------------------------------------------------------------------------------------------

	<p>ATENȚIE!</p> <p>Pericol de deteriorare a componentelor sensibile la electricitatea statică (ESD)! Deteriorarea componentelor</p> <ul style="list-style-type: none">▶ Înainte de a începe lucrul la componentele sensibile la electricitatea statică, folosiți un sistem de protecție împotriva electricității statice (o brățară cu împământare).▶ Nu atingeți conexiunile și căile conductorilor de la module.▶ Transportați componentele sensibile la electricitatea statică numai în materiale conductoare sau în ambalajul original.▶ Păstrați aceste componente departe de materiale care s-ar putea descărca electrostatic (adică plastic).
-------------------------------------------------------------------------------------	-----------------------------------------------------------------------------------------------------------------------------------------------------------------------------------------------------------------------------------------------------------------------------------------------------------------------------------------------------------------------------------------------------------------------------------------------------------------------------------------------------------------------------------------------------------------------------------------------------------------------------------------------------------------------------------------------------------------

Cerință:

 Aparatul este deconectat de la sursa de energie electrică.

1. Deschideți ușa din față a aparatului.

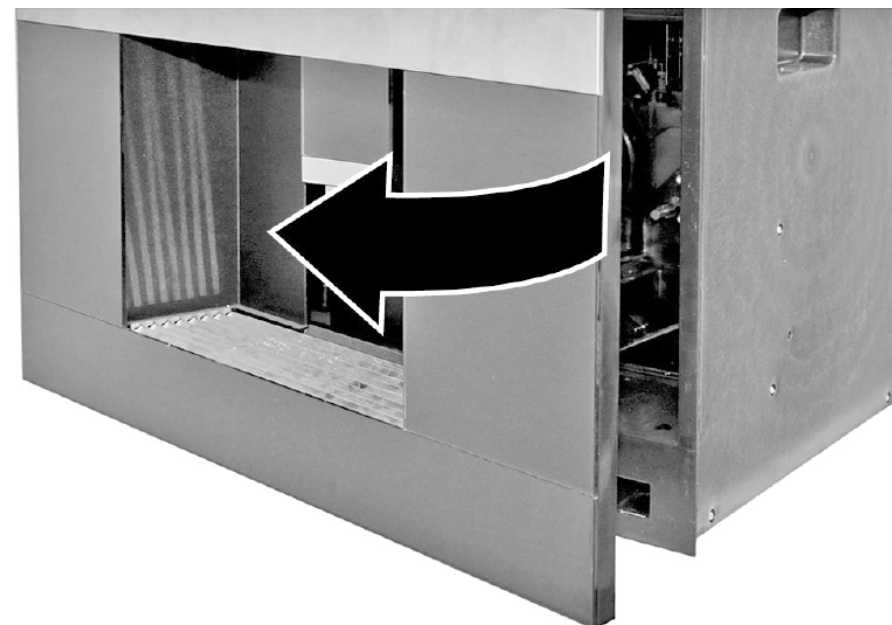

Repararea

2. Trageți și scoateți capacul dispozitivului cu orificiul de evacuare a băuturii.

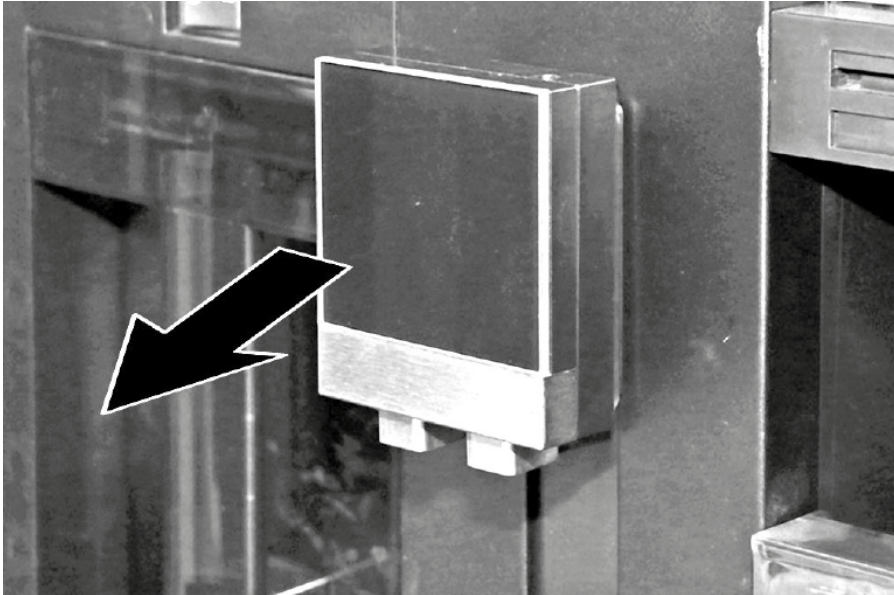

3. Trageți și scoateți dispozitivul cu orificiul de evacuare a băuturii.

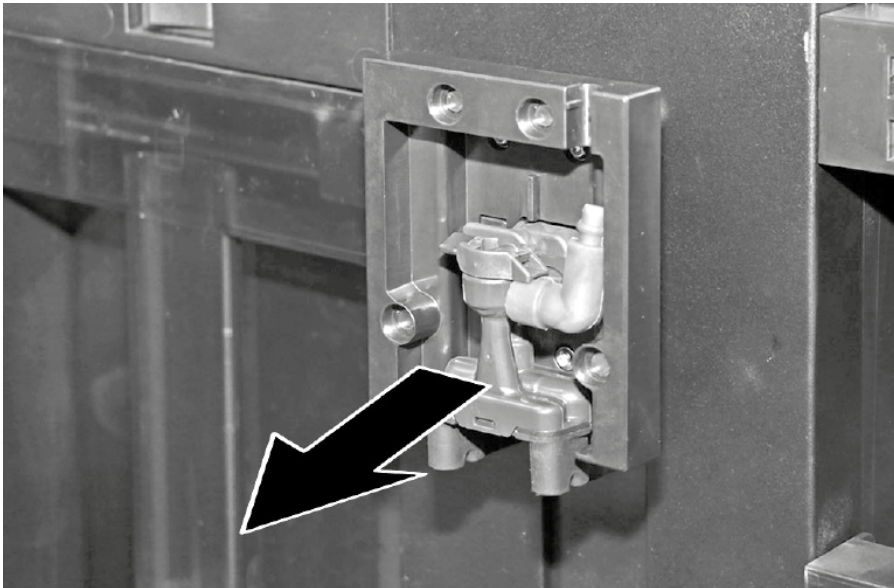

4. Deșurubați patru șuruburi de pe cadrul de susținere a dispozitivului.

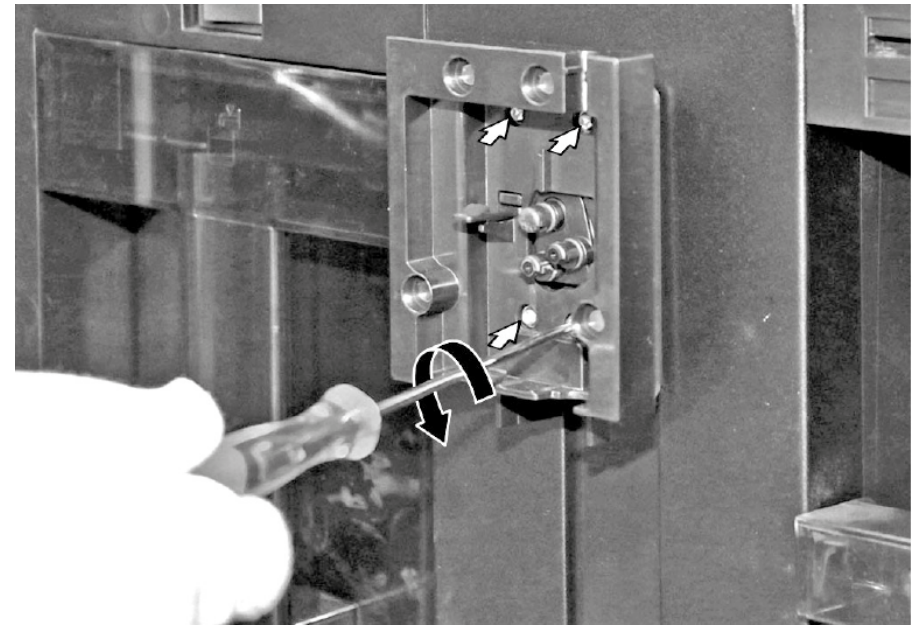

Repararea

5. Trageți cadrul de susținere a dispozitivului, deconectați conectorul electric și scoateți cadrul de susținere.

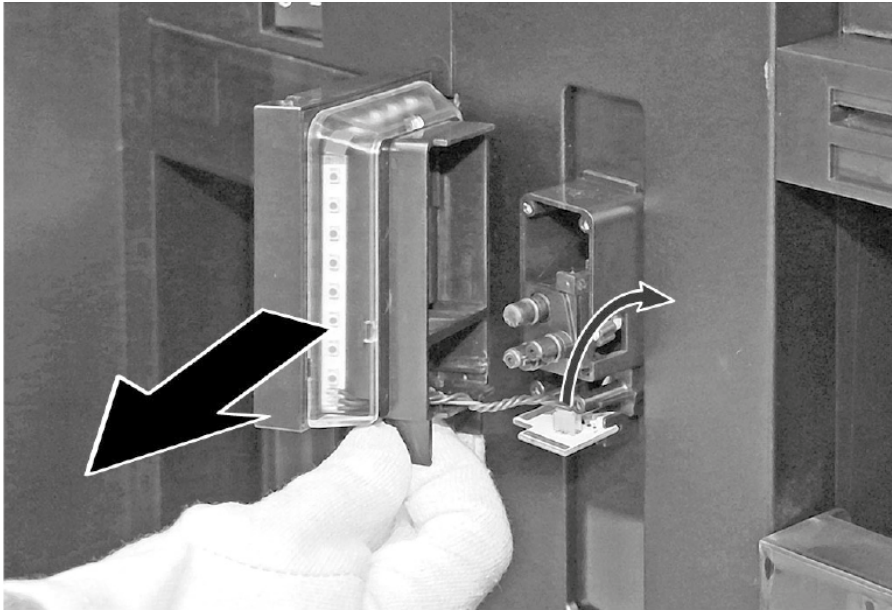

6. Capașul din spate al cadrului de susținere a dispozitivului cu orificiul de evacuare a băuturii cu lumină pentru pahar și sistem de iluminare este demontat.

Poznámky k opravám - Plnoautomatický kávovar

 O tomto dokumente	155
1.1 Dôležité informácie	155
1.1.1 Účel	155
1.2 Vysvetlenie symbolov	155
1.2.1 Úrovne nebezpečenstva	155
1.2.2 Symboly označujúce riziká.....	155
1.2.3 Štruktúra varovaní.....	156
1.2.4 Všeobecné symboly	156
 Bezpečnosť	157
2.1 Všeobecné bezpečnostné pokyny	157
2.1.1 Všetky domáce spotrebiče.....	157
 Nástroje a pomôcky	158
 Oprava	159
4.1 Odobratie zadného krytu výpustu nápojov s osvetlením šálok a osvetlením priestoru	159

i O tomto dokumente

1.1 Dôležité informácie

1.1.1 Účel

Tieto pokyny pre opravu pomáhajú spotrebiteľovi pri vlastnej oprave spotrebičov podľa nariadenia o ekodizajne (z marca 2021).

Obsahujú informácie o výmene určených náhradných dielov vrátane varovaní a rizík.

Ak máte otázky, kontaktujte náš zákaznícky servis. Za poškodenia ručíme len vtedy, ak pokyny boli dodržané správne.

1.2 Vysvetlenie symbolov

1.2.1 Úrovne nebezpečenstva

Úroveň varovania obsahuje symbol a signalizačné slovo. Signalizačné slovo naznačuje mieru nebezpečenstva.





Úroveň varovania	Význam
 NEBEZPEČENSTVO	Následkom nerešpektovania varovného hlásenia je úmrtie alebo vážne zranenia.
 VAROVANIE	Možným následkom nerešpektovania varovného hlásenia je úmrtie alebo vážne zranenia.
 UPOZORNENIE	Možným následkom nerešpektovania varovného hlásenia sú mierne zranenia.
 POZOR!	Možným následkom nerešpektovania varovného hlásenia je poškodenie majetku.

Tabuľka 1: Úrovne nebezpečenstva



1.2.2 Symboly označujúce riziká

Symboly označujúce riziká sú symbolické znázornenia, ktoré naznačujú druh nebezpečenstva.

V tomto dokumente sa používajú nasledujúce symboly označujúce riziká:

Symbol označujúci riziko	Význam
	Všeobecné varovné hlásenie
	Nebezpečenstvo v súvislosti s elektrickým napätím
	Nebezpečenstvo výbuchu
	Nebezpečenstvo porezania
	Nebezpečenstvo pomliaždenia

i O tomto dokumente

Symbol označujúci riziko	Význam
	Nebezpečenstvo v súvislosti s horúcimi povrchmi
	Nebezpečenstvo v súvislosti s magnetickým poľom
	Nebezpečenstvo v súvislosti s neionizujúcou radiáciou

Tabuľka 2: Symboly označujúce riziká

1.2.3 Štruktúra varovaní

Varovania v tomto dokumente majú štandardný vzhľad a štandardnú štruktúru.



	<p>⚠ NEBEZPEČENSTVO</p> <p>Druh a zdroj nebezpečenstva! Možné následky pri ignorovaní nebezpečenstva/varovania.</p> <ul style="list-style-type: none"> ▶ Opatrenia a zákazy na zabránenie nebezpečenstvu.
----------------------------------------------------------------------------------	--------------------------------------------------------------------------------------------------------------------------------------------------------------------------------------------------------------------------------------------





Nasledujúci príklad znázorňuje varovanie pred zásahom elektrickým prúdom pri dotyku s časťami pod napätím. Je uvedené opatrenie na predídenie nebezpečenstvu.

	<p>⚠ NEBEZPEČENSTVO</p> <p>Nebezpečenstvo úrazu elektrickým prúdom pri dotyku s časťami pod napätím! Úmrtie v dôsledku zásahu elektrickým prúdom</p> <ul style="list-style-type: none"> ▶ Odpojte spotrebiče od elektrického zdroja aspoň 60 sekúnd pred začiatkom opráv.
-----------------------------------------------------------------------------------	------------------------------------------------------------------------------------------------------------------------------------------------------------------------------------------------------------------------------------------------------------------------------------------------------------

1.2.4 Všeobecné symboly

V tomto dokumente sa používajú nasledujúce všeobecné symboly:

Všeob. symbol	Význam
	Označenie špeciálneho pokynu (textové a/alebo grafické)
	Označenie jednoduchého pokynu (len textové)

Všeob. symbol	Význam
	Označenie prepojenia na videonávod
	Označenie požadovaných nástrojov
	Označenie požadovaných podmienok
	Označenie podmienky (ak ..., potom ...)
	Označenie výsledku
[Spustenie]	Označenie klávesu alebo tlačidla
[00123456]	Označenie čísla materiálu
Stav	Označenie zobrazeného textu/okna (na displeji spotrebiča)

Tabuľka 3: Všeobecné symboly

2.1 Všeobecné bezpečnostné pokyny

2.1.1 Všetky domáce spotrebiče

Nebezpečenstvo úrazu elektrickým prúdom pri dotyku s časťami pod napätím!

- Chyby pri opravách na elektrických komponentoch môžu spôsobiť zásah elektrickým prúdom!
- Odpojte spotrebič od elektrickej siete aspoň 60 sekúnd pred začiatkom práce.
- Po oprave zariadenia vykonajte bezpečnostný test v súlade s nariadením VDE 0701 alebo s miestnymi nariadeniami.

Riziko poranenia na ostrých hranách!

- Noste ochranné rukavice.

Riziko pomliaždenia počas opravy, údržby, riešenia problémov a servisu na ťažkých a pohybujúcich sa komponentoch

- Noste ochrannú obuv.
- Zaisťte ťažké komponenty proti pádu.
- Nesiahajte končatinami do pohybujúcich sa komponentov.

Riziko ohrozenia bezpečnosti/funkčnosti spotrebiča!

- Používajte len originálne náhradné diely.

Riziko poškodenia elektrostaticky citlivých komponentov (ESD)!

- Nedotýkajte sa modulov vrátane prípojok a vedení vodičov.

Nástroje a pomôcky

Označenie	Detaily	Snímky
Bit Torx TX10 [00340864]	6,3 mm (1/4")	

4.1 Odobratie zadného krytu výpustu nápojov s osvetlením šálok a osvetlením priestoru

Špeciálne nástroje:

 Bit Torx TX10 6,3 mm (1/4") [00340864]

 Vo výbave vášho spotrebiča je bezúdržbové LED svetlo. Tieto svetlá môže opravovať len zákaznícky servis alebo oprávnený technik!

 **NEBEZPEČENSTVO**
Nebezpečenstvo úrazu elektrickým prúdom pri dotyku s časťami pod napätím!
 Ohrozenie života spôsobené elektrickým zásahom v prípade nesprávnej opravy

- ▶ Elektrické diely má opravovať kvalifikovaný elektrikár.
- ▶ Po oprave zariadenie vykonať bezpečnostný test v súlade s nariadením VDE 0701 alebo s miestnymi nariadeniami.

 **NEBEZPEČENSTVO**
Nebezpečenstvo úrazu elektrickým prúdom pri dotyku s časťami pod napätím!
 Úmrtie v dôsledku zásahu elektrickým prúdom

- ▶ Odpojte spotrebiče od elektrického zdroja aspoň 60 sekúnd pred začiatkom opráv.

 **UPOZORNENIE**
Ostré hrany!
 Rezné poranenia

- ▶ Noste ochranné rukavice.

 **POZOR!**
Riziko poškodenia elektrostaticky citlivých komponentov (ESD)!!
 Poškodenie komponentov

- ▶ Pred dotknutím ESD použite systém elektrostatickej ochrany (náramok s uzemňovacou zástrčkou).
- ▶ Nedotýkajte sa prípojok a vedení vodičov modulov.
- ▶ ESD prepravujte iba vo vodivých materiáloch alebo v originálnom balení.
- ▶ ESD udržiavajte mimo materiálov, ktoré tvoria elektrostatický výboj (napr. plast).

Požiadavka:

-  Spotrebič je odpojený od elektrického napájania.
- Otvorte predné dvierka spotrebiča.

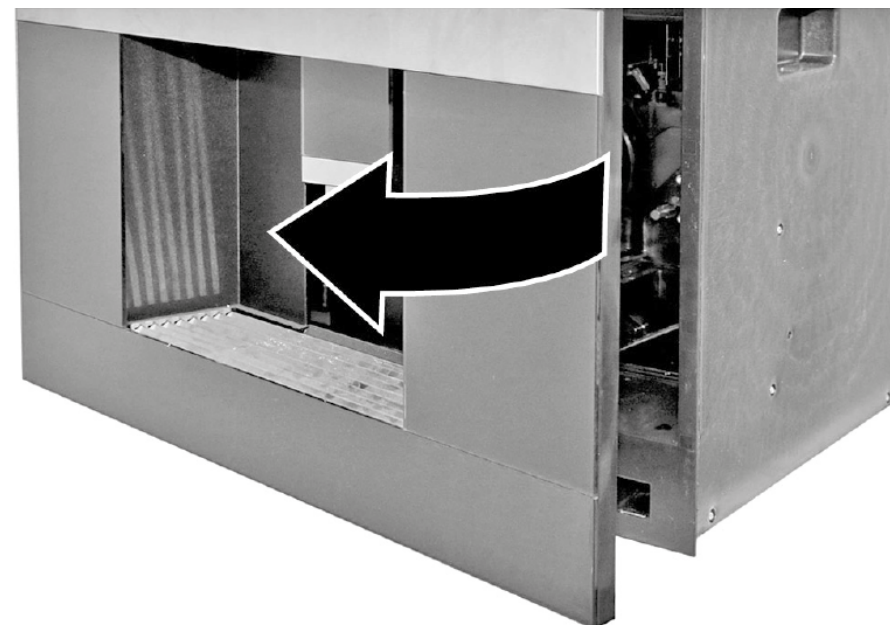

2. Odtiahnite a odoberte kryt výpustu nápoja.

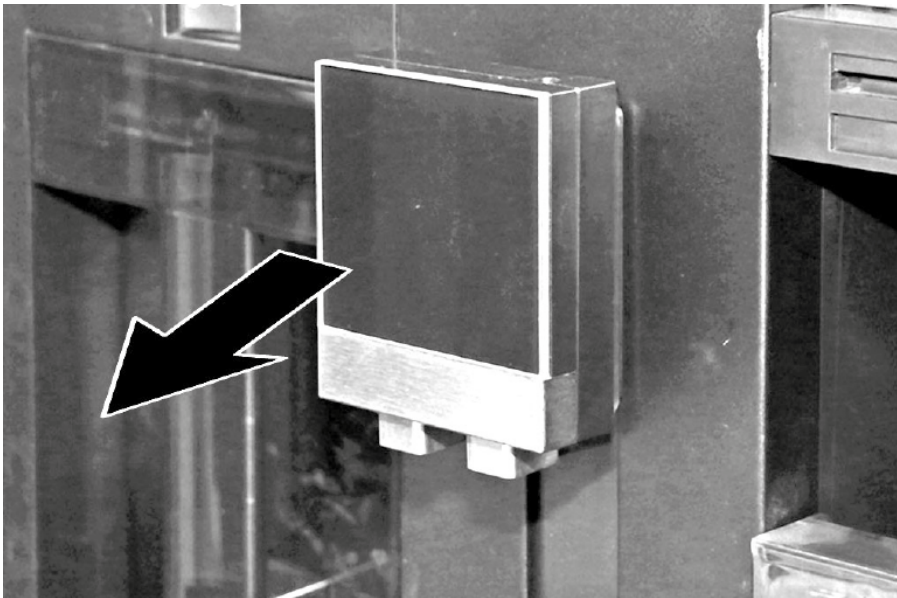

3. Vytiahnite a odstráňte dávkovač výstupu nápoja.

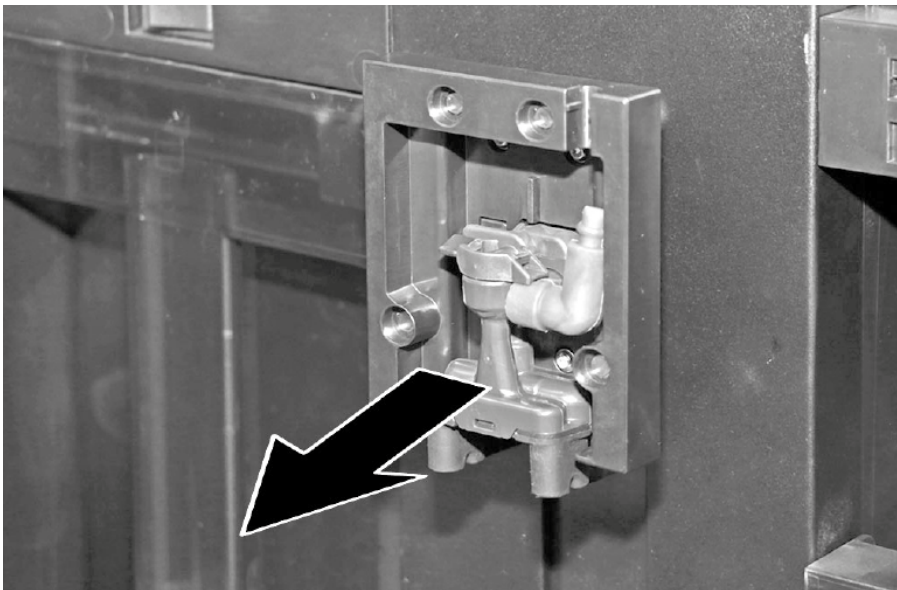

4. Odskrutkujte čtyři skrutky na ráme výpustu.

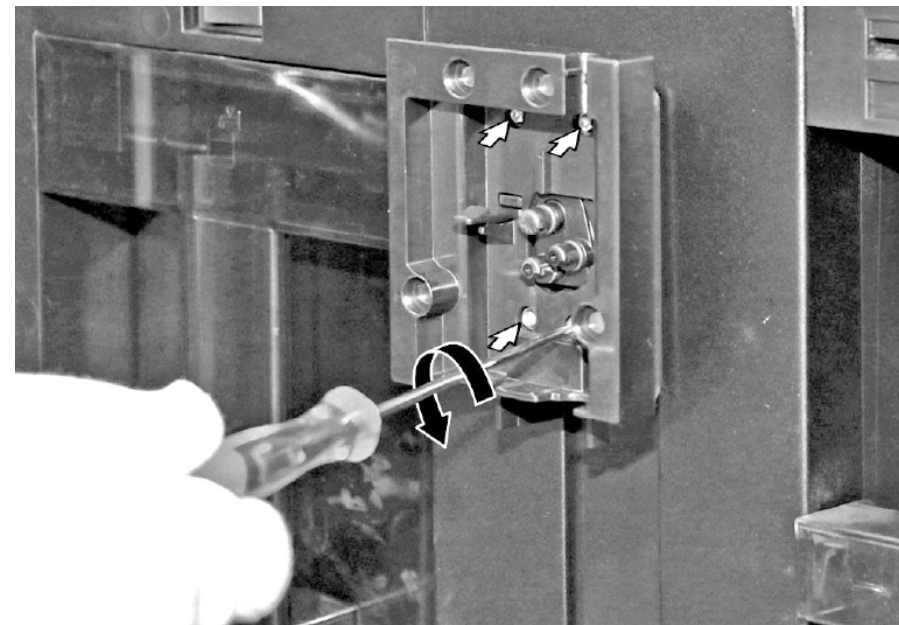



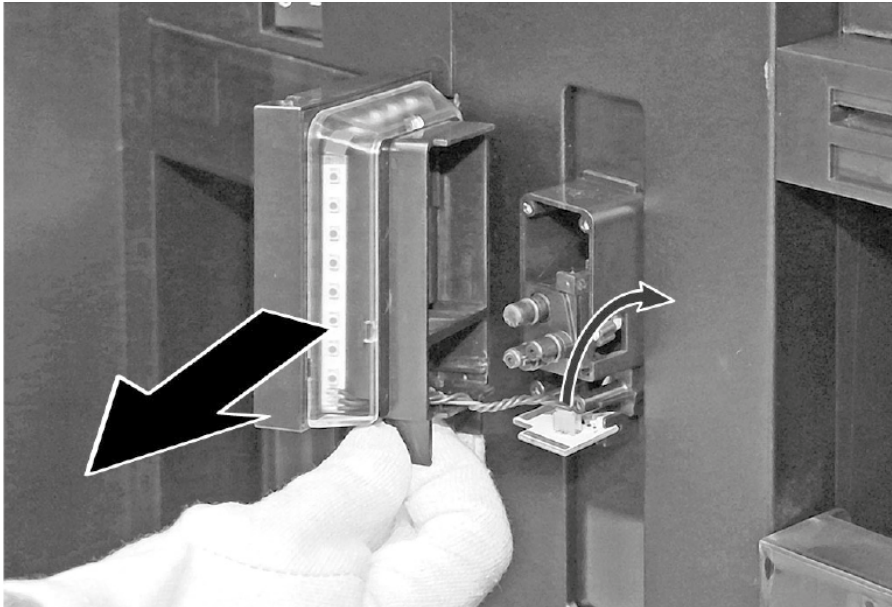

5. Odtiahnite rám výpustu, odpojte elektrický konektor a odoberte rám výpustu.



- ➔ Zadný kryt opory výpustu nápojov s osvetlením šálok a osvetlením priestoru je odobratý.

Nasveti za popravilo - Popolnoma avtomatski kavni aparat

 V zvezi s tem dokumentom	163
1.1 Pomembne informacije	163
1.1.1 Namen	163
1.2 Razlaga simbolov	163
1.2.1 Stopnje nevarnosti	163
1.2.2 Simboli za nevarnost	163
1.2.3 Struktura opozoril	164
1.2.4 Splošni simboli	164
 Varnost.....	165
2.1 Splošna varnostna navodila	165
2.1.1 Vsi gospodinjski aparati	165
 Orodja in pripomočki.....	166
 Popravilo	167
4.1 Odstranjevanje zadnjega pokrova podpornega okvirja iztočne enote za napitke z osvetlitvijo kozarca in osvetlitvijo izliva	167

i V zvezi s tem dokumentom

1.1 Pomembne informacije

1.1.1 Namen

Ti namigi za popravila uporabnika podpirajo pri lastnoročnem popravilu aparatov skladno z veljavno direktivo glede okoljsko primerne zasnove (od marca 2021).





Vsebujejo informacije o tem, kako zamenjati določene rezervne dele, vključno z opozorili in tveganji.

Če imate kakšna vprašanja, se obrnite na našo servisno službo. Za škodo bomo odgovorni le, če ste namige za popravila upoštevali pravilno.

1.2 Razlaga simbolov

1.2.1 Stopnje nevarnosti

Stopnje opozoril so sestavljene iz simbola in signalne besede. Signalna beseda označuje stopnjo nevarnosti.





Stopnja opozorila	Pomen
 NEVARNOST	Neupoštevanje opozorilnega sporočila bo povzročilo smrt ali hude poškodbe.
 OPOZORILO	Neupoštevanje opozorilnega sporočila lahko povzroči smrt ali hude poškodbe.
 PREVIDNO	Neupoštevanje opozorilnega sporočila lahko povzroči manjše poškodbe.
 POZOR!	Neupoštevanje opozorilnega sporočila lahko povzroči škodo na lastnini.

Preglednica 1: Stopnje nevarnosti



1.2.2 Simboli za nevarnost

Simboli za nevarnost so simbolni prikazi, ki podajajo informacije o vrsti nevarnosti.

V tem dokumentu so uporabljeni naslednji simboli za nevarnost:

Simbol za nevarnost	Pomen
	Splošno opozorilno sporočilo
	Nevarnost zaradi električne napetosti
	Nevarnost eksplozije
	Nevarnost ureznin
	Nevarnost zmečkanin

i V zvezi s tem dokumentom

Simbol za nevarnost	Pomen
	Nevarnost zaradi vročih površin
	Nevarnost zaradi močnega magnetnega polja
	Nevarnost zaradi neionizirajočega sevanja

Preglednica 2: Simboli za nevarnost

1.2.3 Struktura opozoril

Opozorila v tem dokumentu imajo standardiziran videz in standardizirano strukturo.



	<div style="background-color: red; color: white; padding: 2px; display: inline-block;">NEVARNOST</div> Vrsta in vir nevarnosti! Morebitne posledice ob neupoštevanju nevarnosti/opozorila. <ul style="list-style-type: none"> ▶ Ukrepi in prepovedi za preprečevanje nevarnosti.
----------------------------------------------------------------------------------	---------------------------------------------------------------------------------------------------------------------------------------------------------------------------------------------------------------------------------------------------------------------------------------------------------------------





V naslednjem primeru je prikazano opozorilo, ki opozarja pred električnim udarom zaradi delov pod napetostjo. Naveden je ukrep za preprečevanje nevarnosti.

	<div style="background-color: red; color: white; padding: 2px; display: inline-block;">NEVARNOST</div> Nevarnost električnega udara zaradi delov pod napetostjo! Smrt zaradi električnega udara <ul style="list-style-type: none"> ▶ Izključite aparate iz električnega omrežja vsaj 60 sekund pred začetkom popravil.
-----------------------------------------------------------------------------------	-----------------------------------------------------------------------------------------------------------------------------------------------------------------------------------------------------------------------------------------------------------------------------------------------------------------------------------------------------------

1.2.4 Splošni simboli

V tem dokumentu so uporabljeni naslednji splošni simboli:

Splošni simbol	Pomen
	Identifikacija posebnega nasveta (besedilo in/ali slika)
	Identifikacija preprostega nasveta (samo besedilo)
	Identifikacija povezave na video vadnico

Splošni simbol	Pomen
	Identifikacija potrebnih orodij
	Identifikacija potrebnih predpogojev
	Identifikacija pogoja (če ..., potem ...)
	Identifikacija rezultata
Začetek	Identifikacija tipke ali gumba
[00123456]	Identifikacija številke dela
Stanje	Identifikacija prikazanega besedila/okna (na zaslonu aparata)

Preglednica 3: Splošni simboli

2.1 Splošna varnostna navodila

2.1.1 Vsi gospodinjski aparati

Nevarnost električnega udara zaradi delov pod napetostjo!

- Napake zaradi popravil električnih komponent lahko povzročijo električni udar!
- Aparat izključite iz električnega omrežja vsaj 60 sekund pred začetkom del.
- Po popravilu je treba izvesti preizkus varnosti v skladu z VDE 0701 ali predpisi, ki veljajo za posamezno državo.

Nevarnost poškodb zaradi ostrih robov!

- Uporabljajte zaščitne rokavice.

Nevarnost zmečkanin med popravili, vzdrževanjem, odpravljanjem težav ali servisom zaradi težkih in premikajočih se komponent

- Uporabljajte zaščitne čevlje.
- Težke komponente zavarujte pred padanjem.
- Delov telesa ne vstavljajte v premikajoče se komponente.

Tveganje za varnost/delovanje aparata!

- Uporabljajte le originalne nadomestne dele.

Tveganje poškodb elektrostatično občutljivih komponent (ESD)!

- Ne dotikajte se modulov, vključno s povezavami in potmi vodnika.

Orodja in pripomočki

Oznaka	Podrobnosti	Slike
Nastavek Torx TX10 [00340864]	6,3 mm (1/4")	

4.1 Odstranjevanje zadnjega pokrova podpornega okvirja iztočne enote za nabitke z osvetlitvijo kozarca in osvetlitvijo izliva

Posebna orodja:

 Nastavek Torx TX10 6,3 mm (1/4") [00340864]



Vaš aparat je opremljen z osvetlitvijo LED, ki ne potrebuje vzdrževanja. To vrsto osvetlitve lahko popravi samo servisna služba ali pooblaščen strokovno osebje!



NEVARNOST

Nevarnost električnega udara zaradi delov pod napetostjo!
Življenjska nevarnost zaradi električnega udara v primeru nepravilnega popravila

- ▶ Električne dele mora popraviti kvalificiran električar.
- ▶ Po popravilu je treba izvesti preizkus varnosti v skladu z VDE 0701 ali predpisi, ki veljajo za posamezno državo.



NEVARNOST

Nevarnost električnega udara zaradi delov pod napetostjo!
Smrt zaradi električnega udara

- ▶ Izključite aparate iz električnega omrežja vsaj 60 sekund pred začetkom popravil.



PREVIDNO

Ostri robovi!
Ureznine

- ▶ Uporabljajte zaščitne rokavice.



POZOR!

Tveganje poškodb elektrostatično občutljivih komponent (ESD)!!
Poškodbe komponent

- ▶ Preden se dotaknete komponent ESD, uporabite sistem elektrostatične zaščite (zapestnico z ozemljitvenim priključkom).
- ▶ Ne dotikajte se povezav in poti vodnikov modulov.
- ▶ Komponente ESD transportirajte le v materialih, ki prevajajo tok, ali v originalni embalaži.
- ▶ Poskrbite, da komponente ESD ne bodo prišle v stik z materialom, ki se elektrostatično naelektri (npr. plastika).

Zahteva:

-  Aparat je odklopljen iz omrežne napetosti.
1. Odprite sprednja vrata aparata.

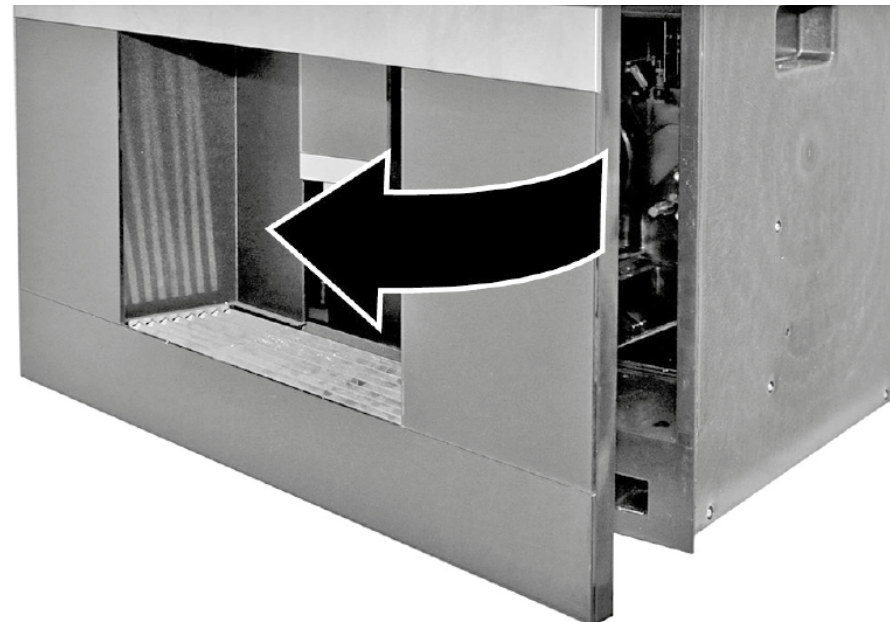

Popravilo

2. Izvlecite in odstranite pokrov iztočne enote za napitke.

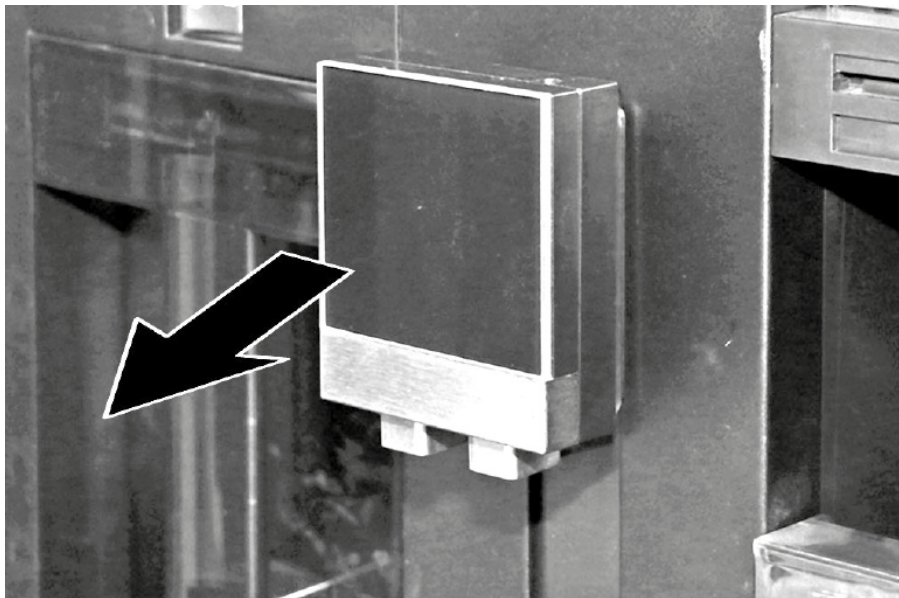

3. Izvlecite in odstranite dozirnik iztočne enote za napitke.

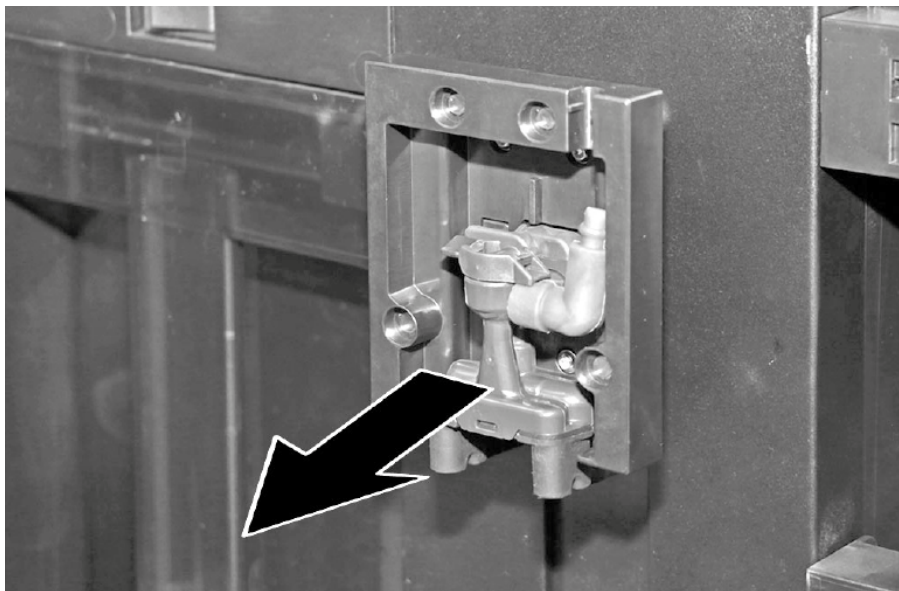

4. Odvijte štiri vijake podpornega okvirja iztočne enote.





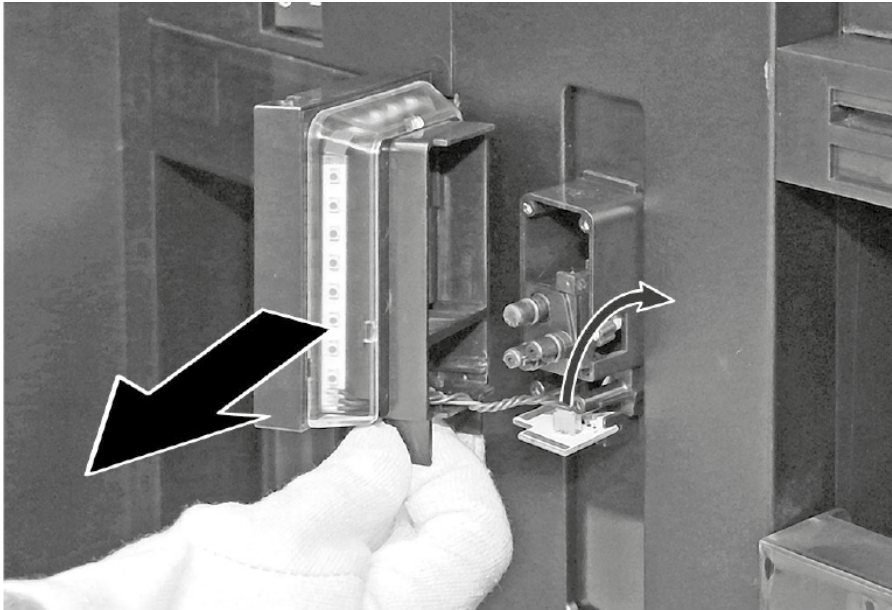

Popravilo

5. Izvlecite podporni okvir iztočne enote, odklopite električni konektor in odstranite podporni okvir iztočne enote.



- ➡ Zadnji pokrov podpornega okvirja iztočne enote za napitke z osvetlitvijo kozarca in osvetlitvijo izliva je odstranjen.

Consejos de reparación - Cafetera automática

 En relación con este documento	171
1.1 Información importante	171
1.1.1 Finalidad	171
1.2 Explicación de símbolos generales	171
1.2.1 Niveles de peligrosidad	171
1.2.2 Símbolos de peligro	171
1.2.3 Estructura de las advertencias	172
1.2.4 Símbolos generales	172
 Seguridad	173
2.1 Instrucciones generales de seguridad	173
2.1.1 Todos los aparatos electrodomésticos.....	173
 Herramientas y auxiliares	174
 Reparación	175
4.1 Retirar la tapa posterior del marco de fijación del dispensador de bebidas con iluminación de la taza e iluminación	175

i En relación con este documento

1.1 Información importante

1.1.1 Finalidad

Estas indicaciones de reparación sirven como ayuda al consumidor para reparar aparatos por su cuenta conforme al reglamento aplicable sobre diseño ecológico (a partir de 03/2021).

Contienen información sobre cómo sustituir repuestos determinados e incluye las advertencias y los riesgos.

En caso de dudas, póngase en contacto con nuestro departamento de atención al cliente. Solo asumiremos la responsabilidad por daños si las indicaciones de reparación se han seguido correctamente.

1.2 Explicación de símbolos generales

1.2.1 Niveles de peligrosidad

Los niveles de peligro consisten en un símbolo y una palabra de advertencia. La palabra de advertencia identifica la gravedad del peligro.







Nivel de peligro	Significado
 PELIGRO	Si no se tiene en cuenta la advertencia, ocasionará la muerte o lesiones graves.
 ADVERTENCIA	Si no se tiene en cuenta la advertencia, puede ocasionar la muerte o lesiones graves.
 PRECAUCIÓN	Si no se tiene en cuenta la advertencia, puede ocasionar lesiones de carácter leve.
ATENCIÓN	Si no se tiene en cuenta la advertencia, puede ocasionar daños materiales.

Tabla 1: Niveles de peligrosidad

1.2.2 Símbolos de peligro

Los símbolos de peligro son una representación simbólica que indica el tipo de peligrosidad.

En este documento se utilizan los siguientes símbolos de peligro:

Símbolo de peligro	Significado
	Advertencia general
	Peligro de lesiones por corriente eléctrica
	Riesgo de explosión
	Peligro de lesiones a causa de cortes

i En relación con este documento





Símbolo de peligro	Significado
	Peligro de lesiones por aplastamiento
	Peligro de lesiones por superficies calientes
	Peligro a causa de campos magnéticos de gran potencia
	Peligro derivado de radiación no ionizante

Tabla 2: Símbolos de peligro

1.2.3 Estructura de las advertencias

Las advertencias de este documento tienen una apariencia y una estructura uniformes.

	<div style="background-color: red; color: white; padding: 2px; text-align: center;">⚠ PELIGRO</div> <p>¡Tipo y fuente del peligro! Posibles consecuencias de ignorar el peligro / la advertencia.</p> <ul style="list-style-type: none"> ▶ Medidas y prohibiciones para prevenir el peligro.
----------------------------------------------------------------------------------	-------------------------------------------------------------------------------------------------------------------------------------------------------------------------------------------------------------------------------------------------------------------------------------------------------------------------------

El ejemplo siguiente muestra una advertencia de descarga eléctrica a causa de piezas o partes cargadas con tensión. Se menciona la medida para evitar el peligro.

	<div style="background-color: red; color: white; padding: 2px; text-align: center;">⚠ PELIGRO</div> <p>¡Riesgo de descarga eléctrica debido a partes con tensión! Muerte por electrocución</p> <ul style="list-style-type: none"> ▶ Desconectar el aparato de la red al menos 60 segundos antes de comenzar con la reparación.
------------------------------------------------------------------------------------	-----------------------------------------------------------------------------------------------------------------------------------------------------------------------------------------------------------------------------------------------------------------------------------------------------------------------------------------------------------------

1.2.4 Símbolos generales

En este documento se utilizan los siguientes símbolos generales:

Símbolo general	Significado
	Identificación de una indicación especial (texto y/o gráfico)







Símbolo general	Significado
	Identificación de un consejo simple (solo texto)
	Identificación de un enlace a un video tutorial
	Identificación de una herramienta requerida
	Identificación de una condición previa (prerrequisito)
	Identificación de una condición (si ..., entonces ...)
	Identificación de un resultado
Iniciar	Identificación de una tecla o botón
[00123456]	Identificación de un número de material
Estado	Identificación del texto / ventana mostrado (en el display del aparato)

Tabla 3: Símbolos generales

2.1 Instrucciones generales de seguridad

2.1.1 Todos los aparatos electrodomésticos

¡Riesgo de descarga eléctrica debido a piezas con tensión!

- ¡Los errores en las reparaciones que incluyan componentes eléctricos pueden provocar una descarga eléctrica!
- Desconectar el aparato de la red durante al menos 60 segundos antes de comenzar con el trabajo.
- Después de la reparación, encargar una prueba de seguridad conforme a VDE 0701 o los reglamentos específicos del país.

¡Riesgo de lesiones debido a bordes afilados!

- Usar guantes de protección.

Riesgo de aplastamiento durante la reparación, mantenimiento, resolución de problemas y servicio debido a componentes pesados y móviles

- Usar calzado de seguridad.
- Asegure los componentes pesados para que no se caigan.
- No pegue partes del cuerpo en componentes móviles.

¡Riesgo para la seguridad/el funcionamiento del aparato!

- Utilizar únicamente los repuestos originales.

¡Riesgo de daños de los componentes sensibles a cargas electrostáticas (ESD)!

- No tocar los módulos, incluidas las conexiones y las pistas conductoras.

Herramientas y auxiliares

Designacion	Detalles	Imágenes
Punta Torx TX10 [00340864]	6,3 mm (1/4")	

4.1 Retirar la tapa posterior del marco de fijación del dispensador de bebidas con iluminación de la taza e iluminación

Herramientas necesarias:

 Punta Torx TX10 6,3 mm (1/4") [00340864]



Su aparato cuenta con una iluminación LED exenta de mantenimiento.
¡Solo el servicio de atención al cliente o los técnicos autorizados pueden reparar esta iluminación!



PELIGRO

¡Riesgo de descarga eléctrica debido a piezas con tensión!
Peligro mortal por descarga eléctrica en caso de reparación inadecuada

- ▶ Las piezas eléctricas deberían ser reparadas por electricistas cualificados.
- ▶ Después de la reparación, encargar una prueba de seguridad conforme a VDE 0701 o los reglamentos específicos del país.



PELIGRO

¡Riesgo de descarga eléctrica debido a partes con tensión!
Muerte por electrocución

- ▶ Desconectar el aparato de la red al menos 60 segundos antes de comenzar con la reparación.



PRECAUCIÓN

¡Bordes o cantos cortantes!
Peligro de cortes

- ▶ Usar guantes de seguridad.



ATENCIÓN

¡Riesgo de daños de los componentes sensibles a descargas electrostáticas (ESD)!

Daños en los componentes

- ▶ Antes de tocar componentes ESD, emplear un sistema de protección electrostática (pulsera de puesta a tierra).
- ▶ No tocar las conexiones ni las pistas conductoras de los módulos.
- ▶ Transportar los componentes ESD únicamente en materiales conductores o en el embalaje original.
- ▶ Mantener los componentes ESD alejados de materiales que puedan cargarse electrostáticamente (por ejemplo, plástico).

Requisito:

-  El aparato está desconectado del suministro eléctrico.
1. Abrir la puerta delantera del aparato.

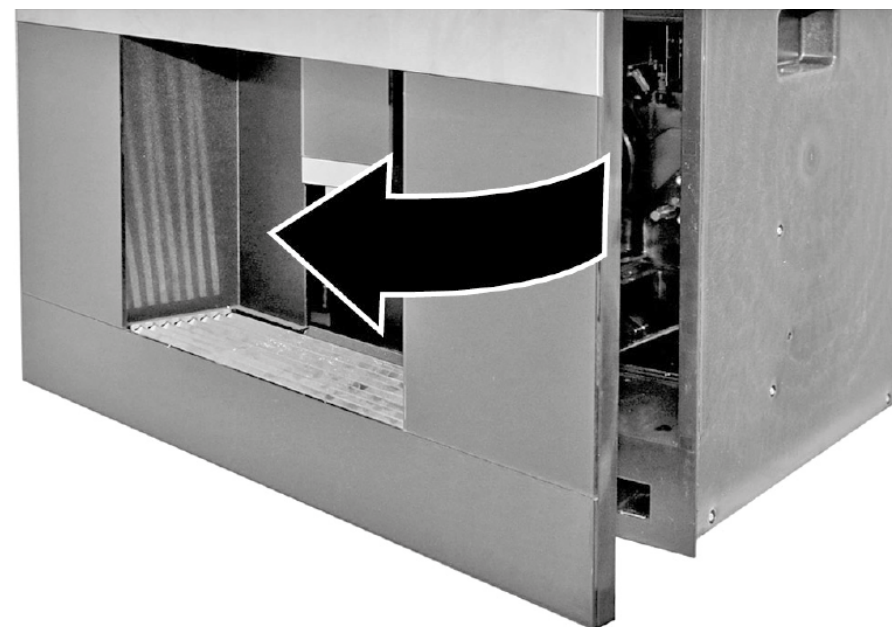

Reparación

2. Sacar y retirar la tapa del dispensador de bebidas.

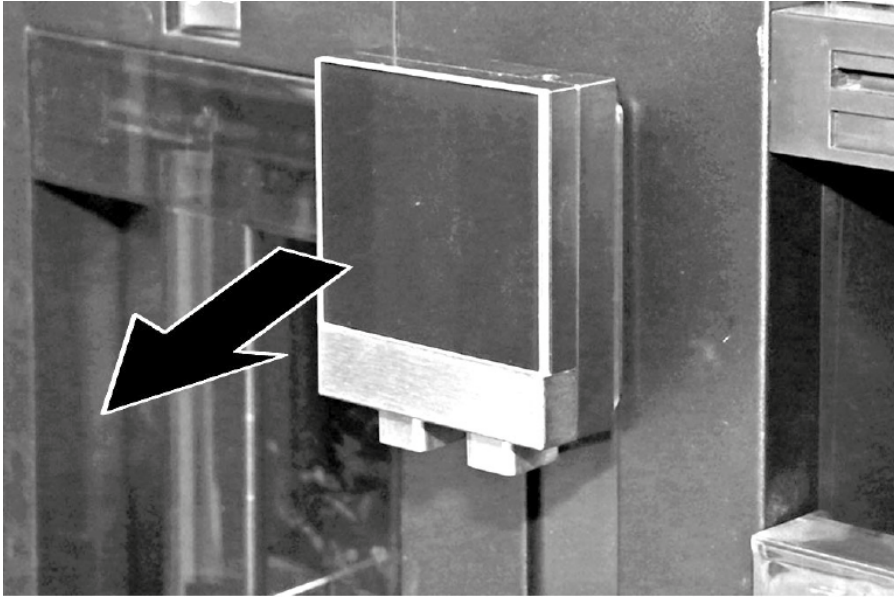

3. Tirar y retirar el dispensador de bebidas.

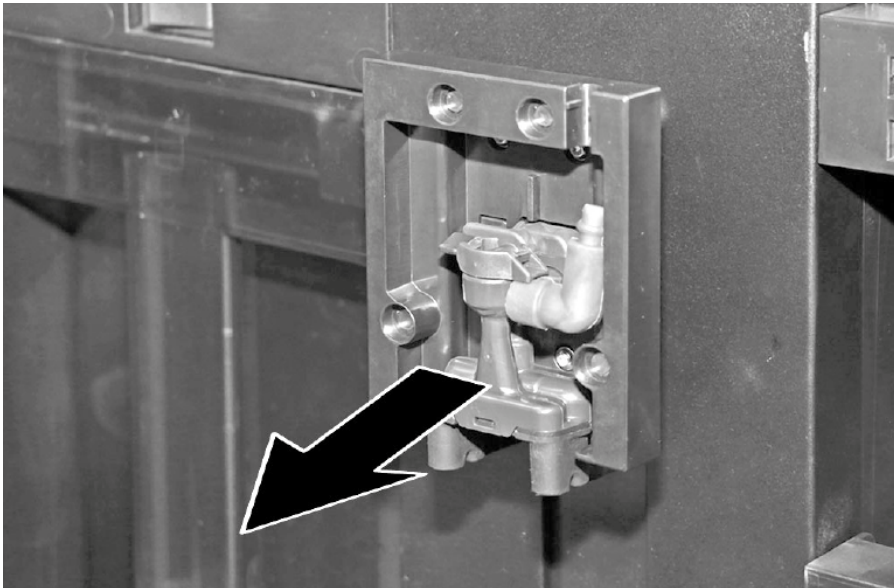

4. Desatornillar los cuatro tornillos del marco de fijación del dispensador.

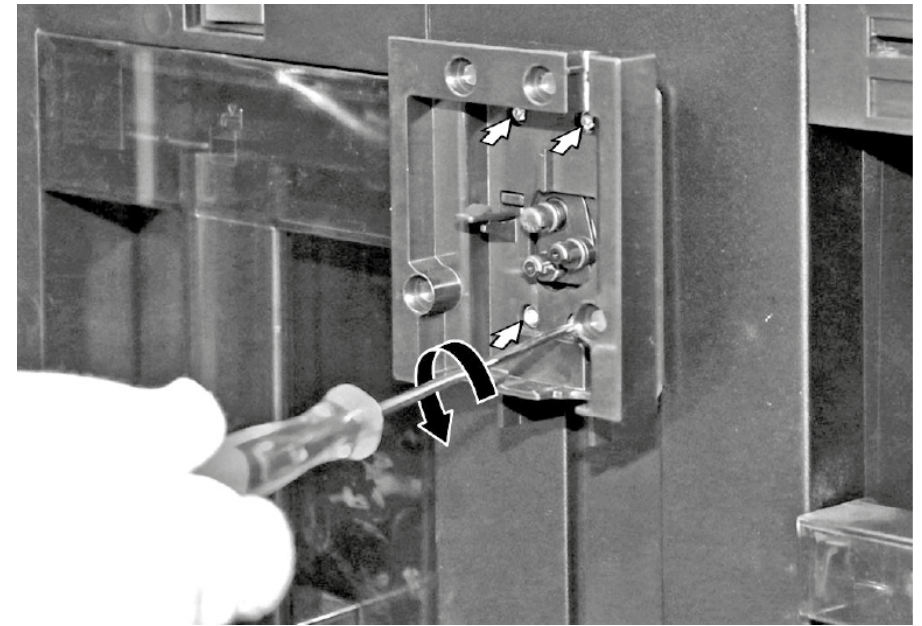



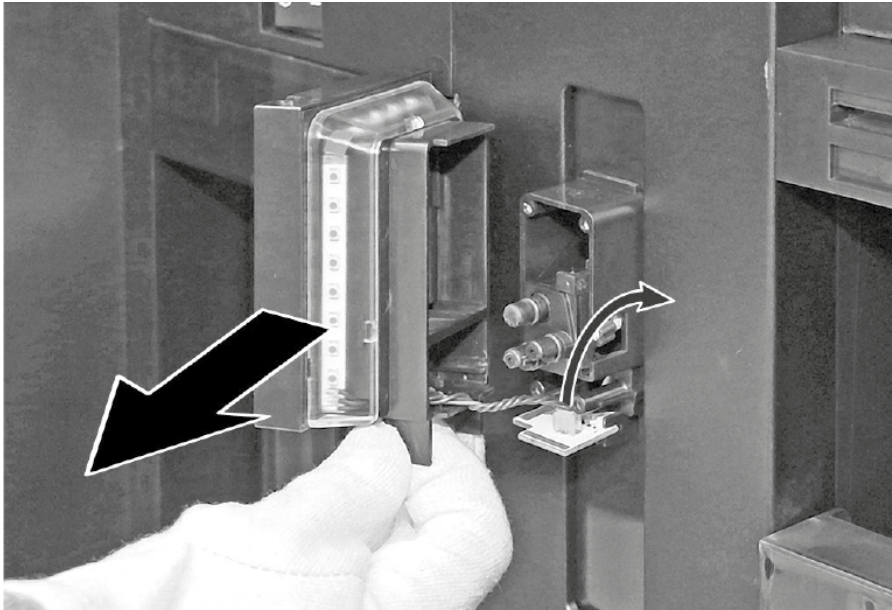

Reparación

5. Sacar el marco de fijación del dispensador, desconectar el conector eléctrico y retirar el marco de fijación del dispensador.



- ➡ Se ha retirado la tapa posterior del marco de fijación del dispensador de bebidas con iluminación de la taza e iluminación.

Reparationsinformation - Helautomatisk kaffemaskin

 Om detta dokument	179
1.1 Viktig information.....	179
1.1.1 Syfte	179
1.2 Symbolförklaringar.....	179
1.2.1 Faronivåer	179
1.2.2 Risksymboler.....	179
1.2.3 Varningarnas struktur	180
1.2.4 Allmänna symboler.....	180
 Säkerhet	181
2.1 Allmänna säkerhetsanvisningar	181
2.1.1 Alla hushållsmaskiner.....	181
 Verktyg och hjälpmedel	182
 Reparation	183
4.1 Ta bort det bakre skyddet för dryckesutloppets stödrum tillsammans med koppbelysningen och utloppets belysning.	183

i Om detta dokument

1.1 Viktig information

1.1.1 Syfte

Dessa reparationstips hjälper kunden att själv reparera maskiner enligt gällande ekodesignbestämmelser (som gäller 03/2021).





De innehåller information om hur vissa reservdelar ska bytas samt tillhörande varningar och risker.

Kontakta vår kundtjänst om du har frågor. Vi åtar oss bara ansvar för skador om reparationstipsen har följts korrekt.

1.2 Symbolförklaringar

1.2.1 Faronivåer

Varningsnivåerna består av en symbol och ett signalord. Signalordet visar hur allvarlig faran är.



Varningsnivå	Innebörd
	Om inte varningsmeddelandet följs kommer det att leda till dödsfall eller allvarliga personskador.
	Om inte varningsmeddelandet följs kan det leda till dödsfall eller allvarliga personskador.
	Om inte varningsmeddelandet följs kan det leda till lättare personskador.
	Om inte varningsmeddelandet följs kan det leda till materialskador.

Grafik 1: Faronivåer



1.2.2 Risksymboler

Risksymboler är symboler som visar typen av fara.

Följande risksymboler används i detta dokument:

Risksymbol	Innebörd
	Allmänt varningsmeddelande
	Fara på grund av elektrisk spänning
	Explosionsrisk
	Fara för skärskador
	Fara för krosskador

i Om detta dokument

Risksymbol	Innebörd
	Fara på grund av heta ytor
	Fara på grund av starka magnetfält
	Fara på grund av icke-joniserande strålning

Grafik 2: Risksymboler

1.2.3 Varningarnas struktur

Varningar i detta dokument har ett standardiserat utseende och en standardiserad struktur.



	 Farans typ och ursprung! Möjliga konsekvenser av att faran/varningen ignoreras. ▶ Åtgärder och förbud för att förebygga faran.
----------------------------------------------------------------------------------	----------------------------------------------------------------------------------------------------------------------------------------------------------------------------------------------------------------------------------





Följande exempel visar en varning som varnar för elstötar från strömförande delar. Det står vilken åtgärd som förebygger faran.

	 Risk för elstötar på grund av strömförande delar! Dödsfall på grund av elstötar ▶ Koppla bort maskiner från elförsörjningen minst 60 sekunder innan reparationer påbörjas.
-----------------------------------------------------------------------------------	-------------------------------------------------------------------------------------------------------------------------------------------------------------------------------------------------------------------------------------------------------------------------------

1.2.4 Allmänna symboler

Följande allmänna symboler används i detta dokument:

Allm. symbol	Innebörd
	Identifiering av ett särskilt tips (text och/eller bild)
	Identifiering av ett enkelt tips (endast text)

Allm. symbol	Innebörd
	Identifiering av en länk till en videohandledning
	Identifiering av verktyg som behövs
	Identifiering av villkor som måste vara uppfyllda
	Identifiering av ett tillstånd (om ..., så ...)
	Identifiering av ett resultat
[Start]	Identifiering av en tangent eller knapp
[00123456]	Identifiering av ett materialnummer
Status	Identifiering av text/fönster som visas (i maskinens display)

Grafik 3: Allmänna symboler

2.1 Allmänna säkerhetsanvisningar

2.1.1 Alla hushållsmaskiner

Risk för elstötar på grund av strömförande delar!

- Fel vid reparationer som berör elkomponenter kan orsaka elstötar!
- Koppla bort maskinen från elnätet minst 60 sekunder innan arbetet påbörjas.
- Låt utföra ett säkerhetstest efter reparationen, i enlighet med VDE 0701 eller landsspecifika regler.

Risk för personskador på grund av vassa kanter!

- Använd skyddshandskar.

Risk för krosskador vid reparation, underhåll, felsökning och service på grund av tunga och rörliga komponenter

- Använd skyddsskor.
- Säkra tunga komponenter så att de inte faller ner.
- Stick inte in kroppsdelar i rörliga komponenter.

Risk för maskinens säkerhet/funktion!

- Använd endast originaldelar.

Risk för skador på komponenter känsliga för statisk elektricitet (ESD)!

- Rör inte modulerna samt anslutningar och strömförande ledningar.

Verktyg och hjälpmedel

Beteckning	Detaljer	Bilder
Torxbits TX10 [00340864]	6,3 mm (1/4")	

Reparation

4.1 Ta bort det bakre skyddet för dryckesutloppets stödrum tillsammans med koppbelysningen och utloppets belysning.

Nödvändiga verktyg:

 Torxbits TX10 6,3 mm (1/4") [00340864]

 Apparatens har underhållsfria LED-lampor. Sådana lampor får bara bytas av kundtjänsten eller av auktoriserade tekniker!

 **FARA!**
Risk för elstötar på grund av strömförande delar!
Livsfara på grund av elstötar vid felaktiga reparationer

- ▶ Elektriska delar ska repareras av behörig elektriker.
- ▶ Låt utföra ett säkerhetstest efter reparationen, i enlighet med VDE 0701 eller landsspecifika regler.

 **FARA!**
Risk för elstötar på grund av strömförande delar!
Dödsfall på grund av elstötar

- ▶ Koppla bort maskiner från elförsörjningen minst 60 sekunder innan reparationer påbörjas.

 **FÖRSIKTIGT!**
Vassa kanter!
Skärskador

- ▶ Använd skyddshandskar.

 **OBS!**
Risk för skador på komponenter som är känsliga för statisk elektricitet (ESD)!
Skador på komponenter

- ▶ Använd ett elektrostatiskt skyddssystem (ESD-armband) innan du rör en ESD-känslig komponent.
- ▶ Rör inte modulernas anslutningar och strömförande ledningar.
- ▶ Transportera bara ESD-känsliga komponenter i ledande material eller i originalförpackningen.
- ▶ Håll ESD-känsliga komponenter borta från material som kan laddas av statisk elektricitet (t.ex. plast).

Förutsättning:

-  Apparatens är bortkopplad från strömförsörjning.
1. Öppna apparatens främre dörr.

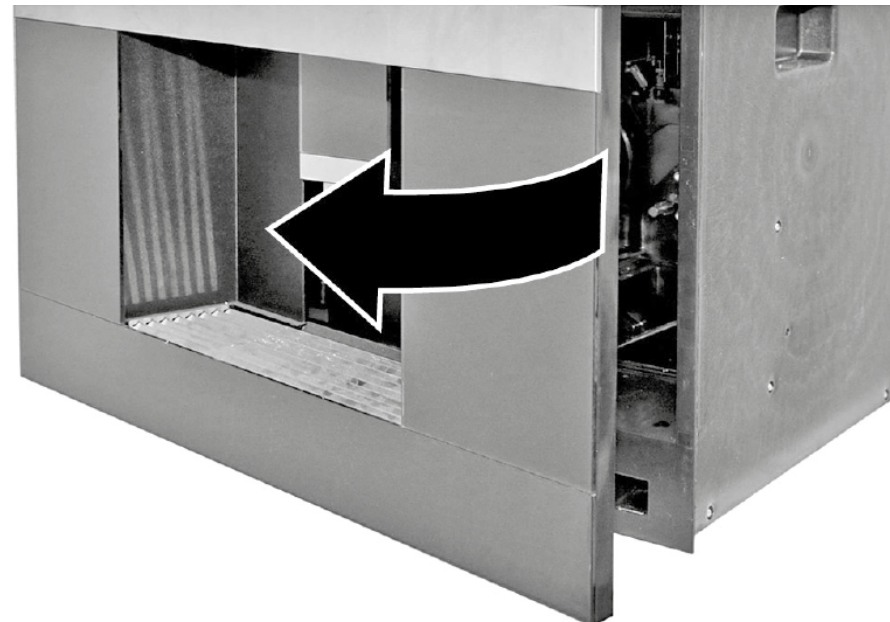

Reparation

2. Dra av och ta bort kåpan för dryckesutloppet.

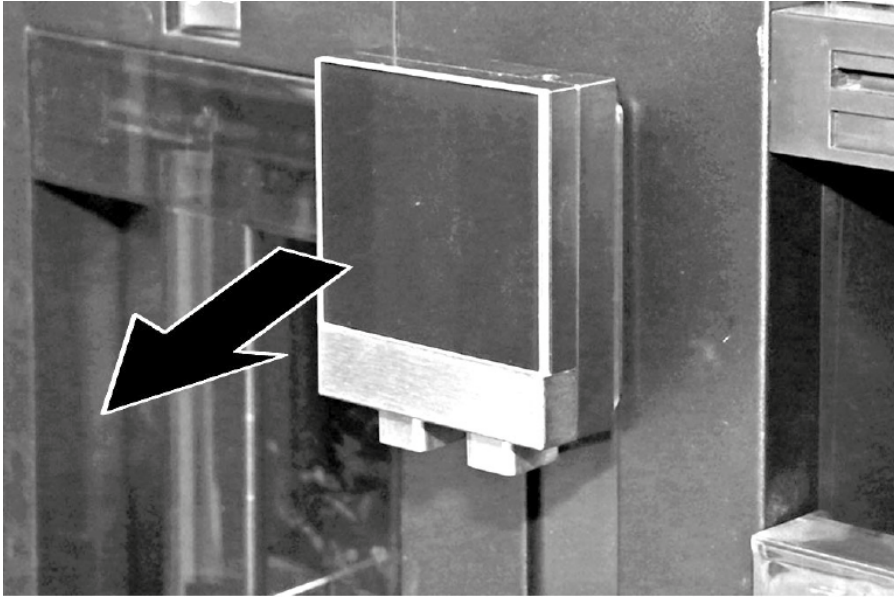

3. Dra ut och ta bort dryckserveringen.

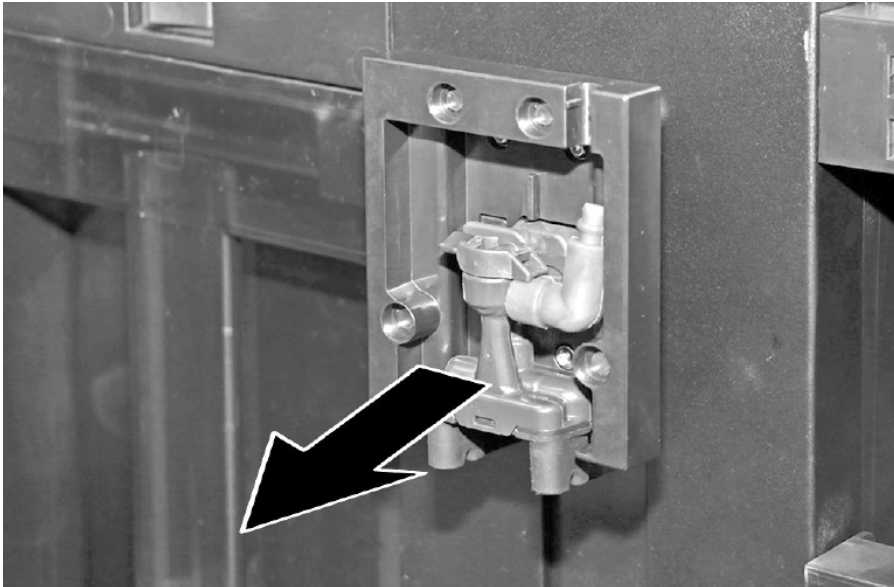

4. Skruva loss de fyra skruvarna på utloppets stödram.

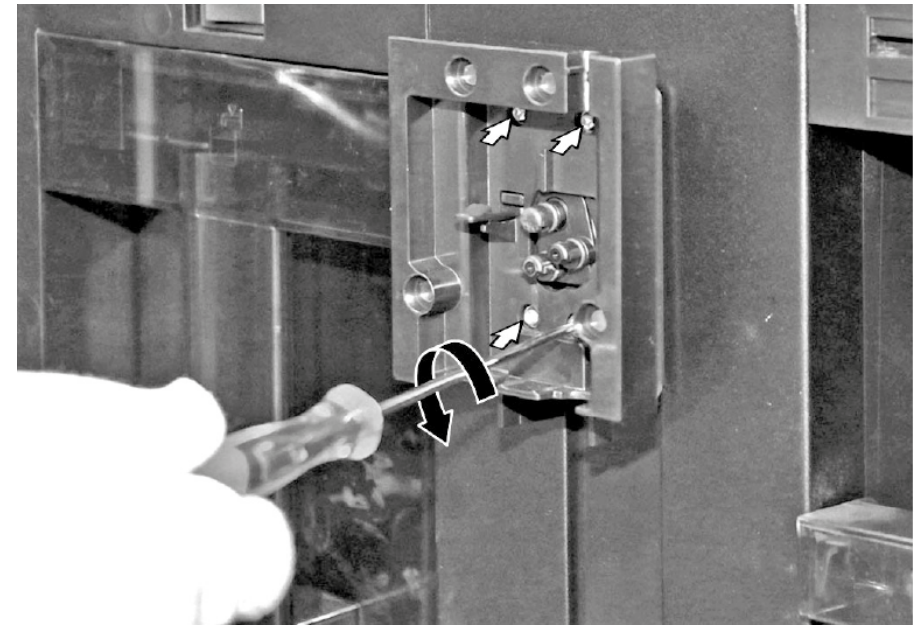



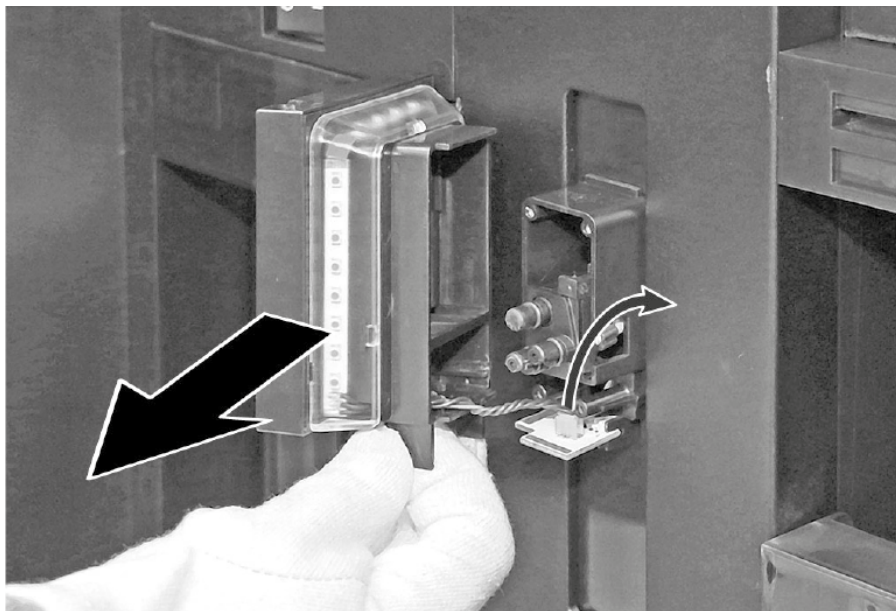

Reparation

5. Dra loss utloppets stödrum, koppla bort den elektriska kontakten och ta bort utloppets stödrum.



-  Det bakre skyddet för dryckesutloppets stödrum har tagits bort tillsammans med koppelbelysningen och belysningen för utloppet.

Onarım İpuçları - Tam otomatik kahve pişirme makinesi

 Bu doküman hakkında	187
1.1 Önemli bilgi	187
1.1.1 Amacı.....	187
1.2 Sembollerinin açıklaması	187
1.2.1 Tehlike kademeleri	187
1.2.2 Tehlike sembolleri	187
1.2.3 İkaz bilgilerinin yapısı	188
1.2.4 Genel semboller.....	188
 Güvenlik	189
2.1 Genel Güvenlik bilgileri	189
2.1.1 Tüm ev gereçleri	189
 Ekipman ve yardım	190
 Onarım	191
4.1 Fincan ve sahne aydınlatmalı içecek çıkışı destek şasisi arka kapağının sökülmesi.....	191

i Bu doküman hakkında

1.1 Önemli bilgi

1.1.1 Amacı

Bu onarım ipuçları, tüketicinin cihazları, geçerli eko-tasarım yönetmeliğine göre (03/2021 itibarıyla) kendi başına onarması için destek sunar.

İpuçları, ilgili uyarı ve riskler de dahil olmak üzere tanımlanmış yedek parçaların nasıl değiştirilmesi gerektiğine dair bilgiler içerir.

Sorularınız varsa, lütfen müşteri hizmetlerimizle irtibata geçin. Yalnızca onarım ipuçlarına gerektiği gibi uyulduğu takdirde hasarlar için sorumluluk üstleniriz.

1.2 Sembollerinin açıklaması

1.2.1 Tehlike kademeleri

Tehlike kademeleri bir sembolden ve bir sinyal kelimesinden oluşur. Sinyal kelimesi tehlikenin şiddetini ve önemini tanımlar.





Tehlike kademesi	Anlamı
 TEHLİKE	İkaz bilgisinin dikkate alınmaması ölüme veya ağır yaralanmalara sebep olur.
 UYARI	İkaz bilgisinin dikkate alınmaması ölüme veya ağır yaralanmalara sebep olabilir.
 DİKKAT	İkaz bilgisinin dikkate alınmaması hafif yaralanmalara sebep olabilir.
DİKKATI	İkaz bilgisinin dikkate alınmaması maddi hasarların oluşmasına sebep olabilir.

Tablo 1: Tehlike kademeleri



1.2.2 Tehlike sembolleri

Tehlike sembolleri, tehlike türü hakkında bilgi veren anlamlı resimsel gösterimlerdir.

Bu dokümanda aşağıdaki tehlike sembolleri kullanılmıştır:

Tehlike sembolü	Anlamı
	Genel ikaz bilgisi
	Elektrik geriliminden kaynaklanan tehlike
	Patlamadan kaynaklanan tehlike
	Kesmeden dolayı yaralanma tehlikesi
	Sıkışıp ezilmeden dolayı yaralanma tehlikesi

i Bu doküman hakkında

Tehlike sembolü	Anlamı
	Sıcak yüzeylerden kaynaklanan tehlike
	Güçlü elektromanyetik alan tehlikesi
	İyonizasyon olmayan ışınlardan kaynaklanan tehlike

Tablo 2: Tehlike sembolleri

1.2.3 İkaz bilgilerinin yapısı

Bu dokümandaki ikaz bilgilerinin standart olarak görünüşü ve yapısı aynıdır.



	⚠ TEHLİKE Tehlikenin türü ve kaynağı!! Tehlike / ikaz bilgisinin dikkate alınmamasının sonucu. ► Tehlikeye karşı korunmak için yapılacak işlem ve yasaklar.
----------------------------------------------------------------------------------	------------------------------------------------------------------------------------------------------------------------------------------------------------------------------------







Aşağıdaki örnekte, gerilim ileten parçalar nedeniyle oluşabilecek elektrik çarpması tehlikesi hakkında uyarıda bulunan bir ikaz bilgisi gösterilmiştir. Tehlikeyi önlemek için alınması gereken önlemler belirtilmiştir.

	⚠ TEHLİKE Gerilim ileten parçalar nedeniyle elektrik çarpması tehlikesi!! Elektrik çarpması sebebiyle ölüm ► Onarıma başlamadan önce cihazın elektrik şebeke bağlantısını en az 60 saniye süreyle sökün.
------------------------------------------------------------------------------------	---------------------------------------------------------------------------------------------------------------------------------------------------------------------------------------------------------------------------------

1.2.4 Genel semboller

Bu dokümanda aşağıdaki genel semboller kullanılmıştır:

Genel sembol	Anlamı
	Özel ipucu işareti (metin ve/veya grafik)
	Basit ipucu işareti (yalnızca metin)
	Video linki işareti

Genel sembol	Anlamı
	Gerekli araçlar işareti
	Ön koşulların işareti
	Koşul işareti (... olursa olur)
	Sonuç işareti
	Tuş veya düğme işareti
	Malzeme numarası işareti
	Gösterilen yazı / ekran işareti (cihaz ekranındaki)

Tablo 3: Genel semboller

2.1 Genel Güvenlik bilgileri

2.1.1 Tüm ev gereçleri

Gerilim ileten parçalar nedeniyle elektrik çarpması tehlikesi!

- Elektrikli bileşenlerde yapılan onarımlarda hatalar, elektrik çarpmasına neden olabilir!
- Cihaz çalışmalara başlamadan en az 60 saniye önce elektrik şebekesinden ayrılmalıdır.
- Onarım sonrasında VDE 0701 veya ülkeye özel düzenlemeler uyarınca bir güvenlik testi gerçekleştirilmelidir.

Keskin kenarlar nedeniyle yaralanma tehlikesi!

- Koruyucu eldiven kullanılmalıdır.

Ağır ve hareketli parçaların onarım, bakım, hata arama ve servis işlemlerinde yaratabileceği ezilme riskleri

- Koruyucu ayakkabı giyin.
- Yere düşmemesi için ağır parçaları emniyete alın.
- Hareketli parçaların arasına gövde parçaları koymayın.

Cihaz güvenliğinde / fonksiyonda tehlike!

- Yalnızca orijinal parçalar kullanılmalıdır.

Elektrostatik hassasiyeti olan bileşenlerde hasar tehlikesi (ESD)!

- Bağlantılar ve iletken yolları da dahil olmak üzere modüllere dokunmayın.

Ekipman ve yardım

Tanımlama	Detaylar	Görüntüler
Torx- TX10 [T25]	6,3 mm (1/4")	

4.1 Fincan ve sahne aydınlatmalı içecek çıkışı destek şasisi arka kapağının sökülmesi

Özel yardımcı ekipman:

 Torx- TX10

6,3 mm (1/4")

[T25]

	Cihazınızda bakım gerektirmeyen bir LED lamba bulunmaktadır. Bu lambalar sadece müşteri hizmetleri veya yetkili teknisyenler tarafından onarılabilir!
-----------------------------------------------------------------------------------	-------------------------------------------------------------------------------------------------------------------------------------------------------

	⚠ TEHLİKE Gerilim ileten parçalar nedeniyle elektrik çarpması tehlikesi!! Onarımın düzgün yapılmaması nedeniyle elektrik çarpması sonucu hayati tehlike <ul style="list-style-type: none">▶ Elektrikli parçaların onarımı kalifiye bir elektrik uzmanı tarafından gerçekleştirilmelidir.▶ Onarım sonrasında VDE 0701 veya ülkeye özel düzenlemeler uyarınca bir güvenlik testi gerçekleştirilmelidir.
----------------------------------------------------------------------------------	--------------------------------------------------------------------------------------------------------------------------------------------------------------------------------------------------------------------------------------------------------------------------------------------------------------------------------------------------------------------------------------------------------------------------------------------------

	⚠ TEHLİKE Gerilim ileten parçalar nedeniyle elektrik çarpması tehlikesi!! Elektrik çarpması sebebiyle ölüm <ul style="list-style-type: none">▶ Onarıma başlamadan önce cihazın elektrik şebeke bağlantısını en az 60 saniye süreyle sökün.
----------------------------------------------------------------------------------	------------------------------------------------------------------------------------------------------------------------------------------------------------------------------------------------------------------------------------------------------------------------------

	⚠ DİKKAT Keskin köşeler! Kesik yaralanmaları <ul style="list-style-type: none">▶ Korumucu eldiven kullanılmalıdır.
-----------------------------------------------------------------------------------	------------------------------------------------------------------------------------------------------------------------------------------------------

	DİKKAT! Elektrostatik hassasiyeti olan bileşenlerde (ESD'ler) hasar tehlikesi! Bileşenlerin hasar görmesi <ul style="list-style-type: none">▶ Elektrostatik hassasiyeti olan bileşenlere dokunmadan önce bir elektrostatik koruma sistemi (topraklamalı bileklik) takılmalıdır.▶ Modülün bağlantılarına ve iletken yollarına temas edilmemelidir.▶ Elektrostatik hassasiyeti olan bileşenler yalnızca iletken malzemeler içinde veya orijinal ambalajında taşınmalıdır.▶ Elektrostatik hassasiyeti olan bileşenler, elektrostatik olarak yüklenebilecek malzemelerden (örneğin plastiklerden) uzak tutulmalıdır.
-------------------------------------------------------------------------------------	-------------------------------------------------------------------------------------------------------------------------------------------------------------------------------------------------------------------------------------------------------------------------------------------------------------------------------------------------------------------------------------------------------------------------------------------------------------------------------------------------------------------------------------------------------------------------------------------------------------------------------------------------------------------------------

Ön kopul:

- ✔ Cihazın fişi çekilir.
- 1. Cihazın ön kapısını açın.

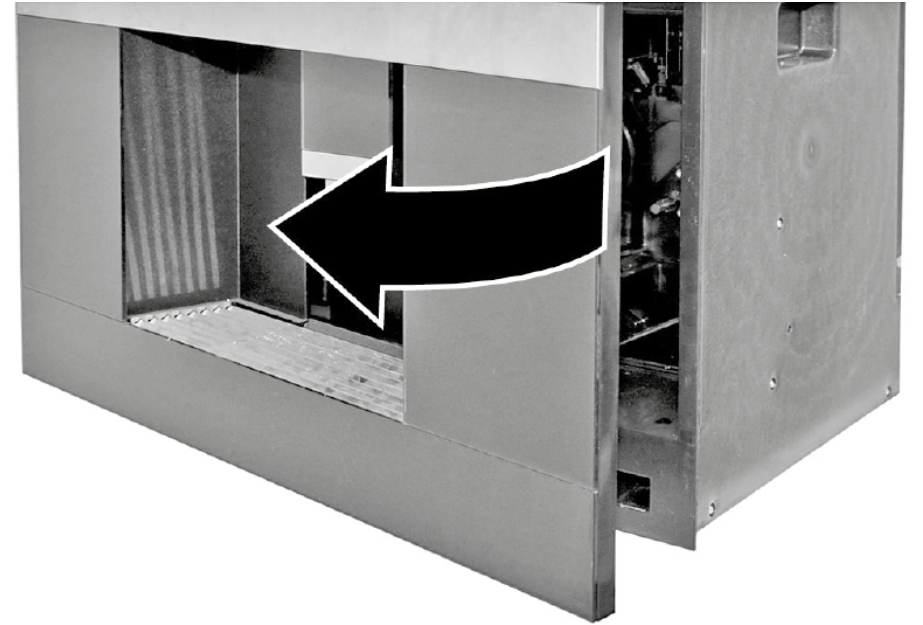

2. İçecek çıkışı kapağını çekip çıkarın.

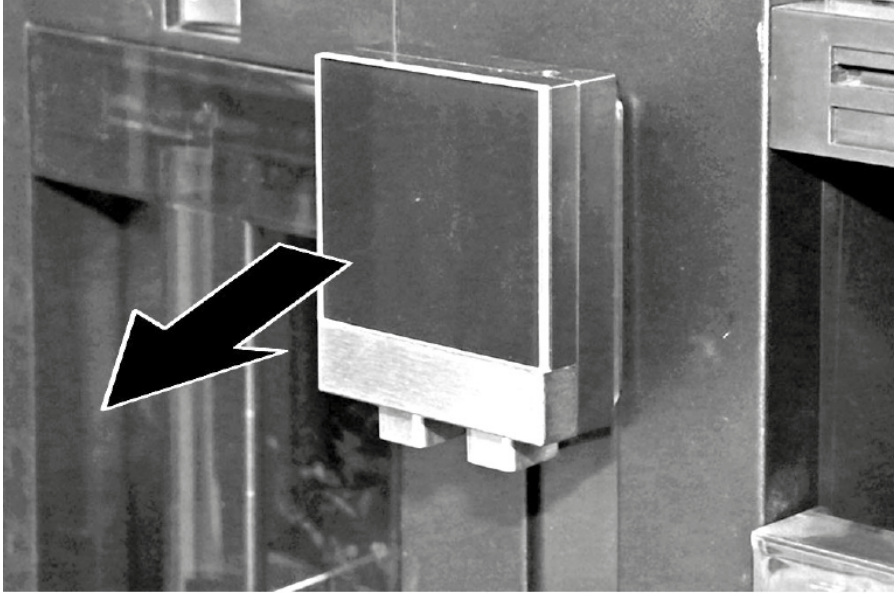

3. İçecek çıkışı dağıtıcısını çekip çıkarın.

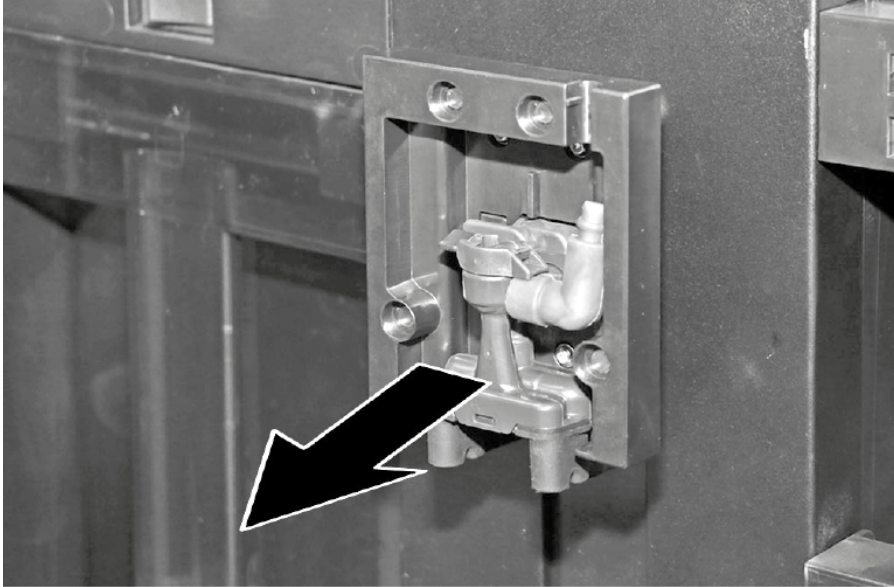

4. Çıkış destek şasisi üzerindeki dört vidayı sökün.

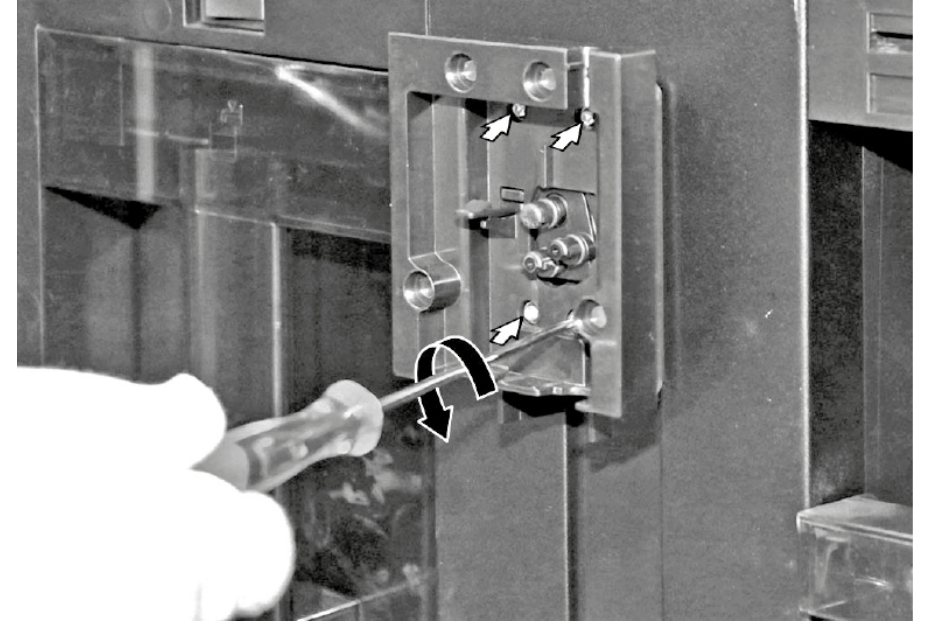

5. Çıkış destek şasisi çekin, elektrik konnektörünün bağlantısını kesin ve çıkış destek şasisini çıkarın.

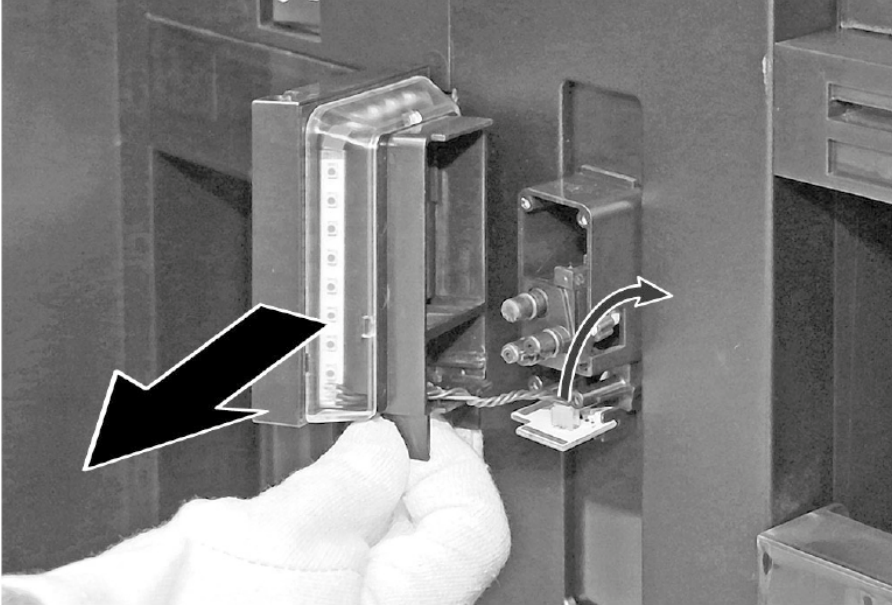

- ➡ Fincan ve sahne aydınlatmalı içecek çıkışı destek şasisi arka kapağının sökülmesi işlemi tamamlanmıştır.