



立即注册您的新博世产品：  
[www.bosch-home.cn](http://www.bosch-home.cn)



## 全自动咖啡机 CTL636E.6



**BOSCH**

zh 使用说明书  
en Instruction manual

使用产品前请仔细阅读本使用说明书，并请妥善保管

**A**

供货范围 (参见第 6 页)

Included in delivery (see page 29)

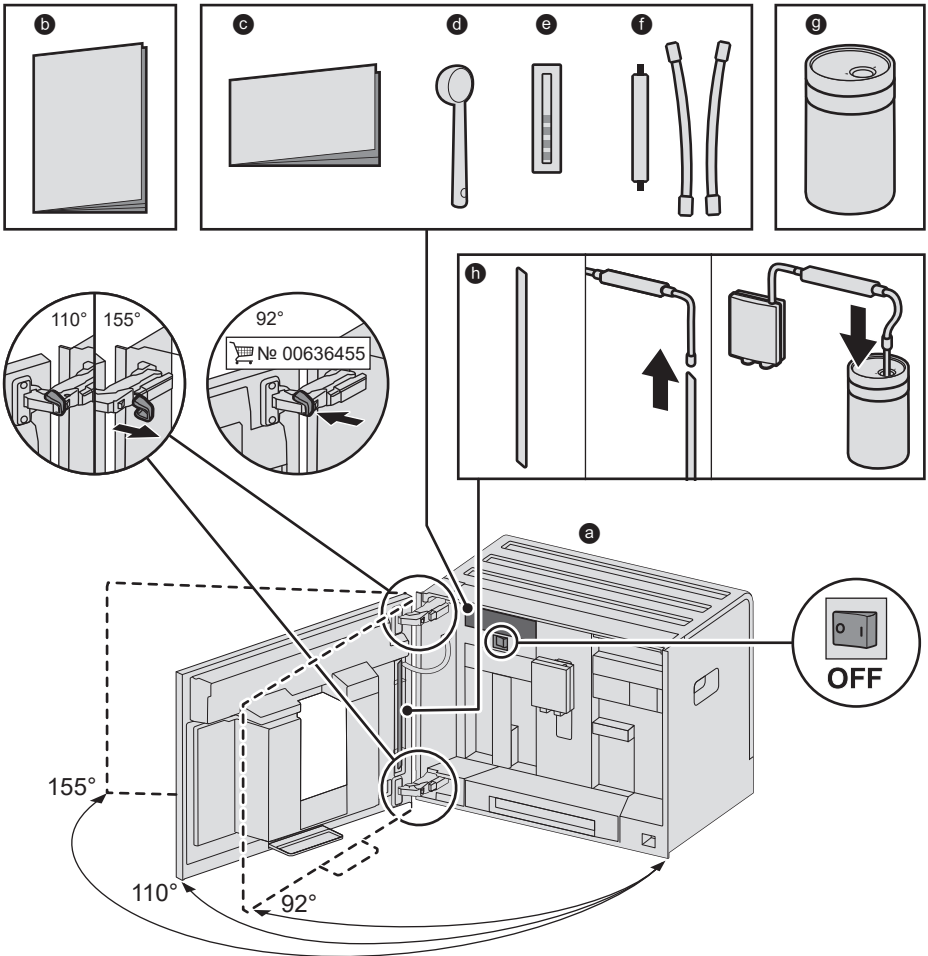

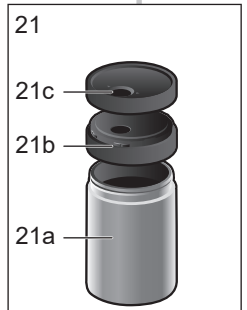
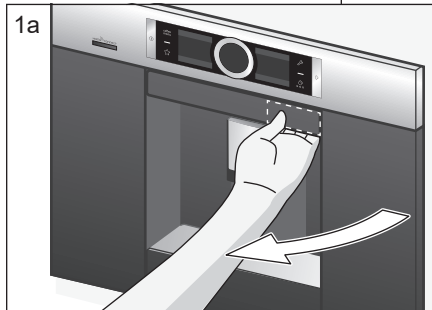
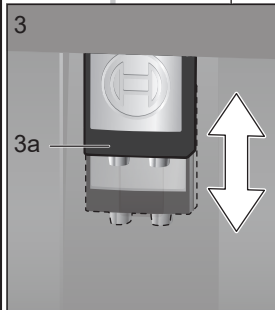
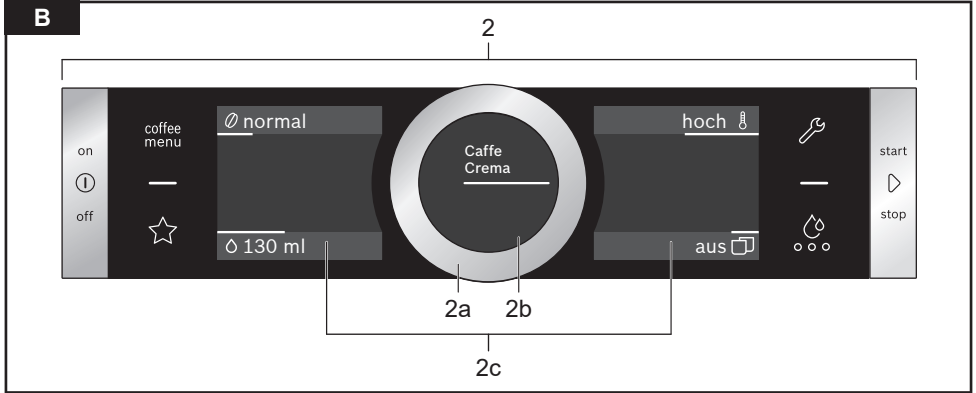

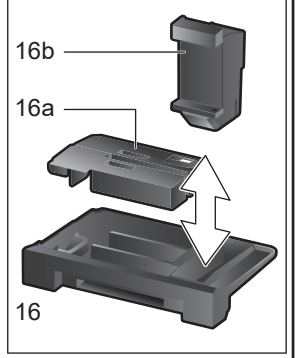
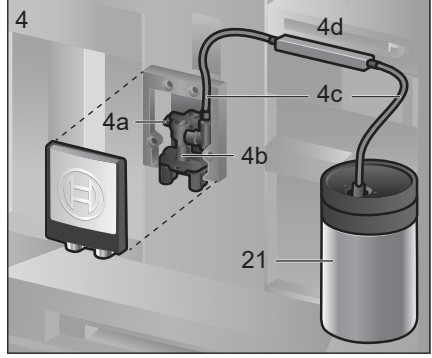
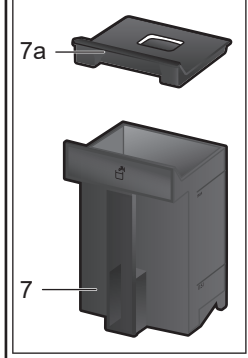
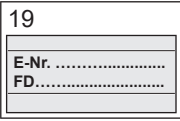
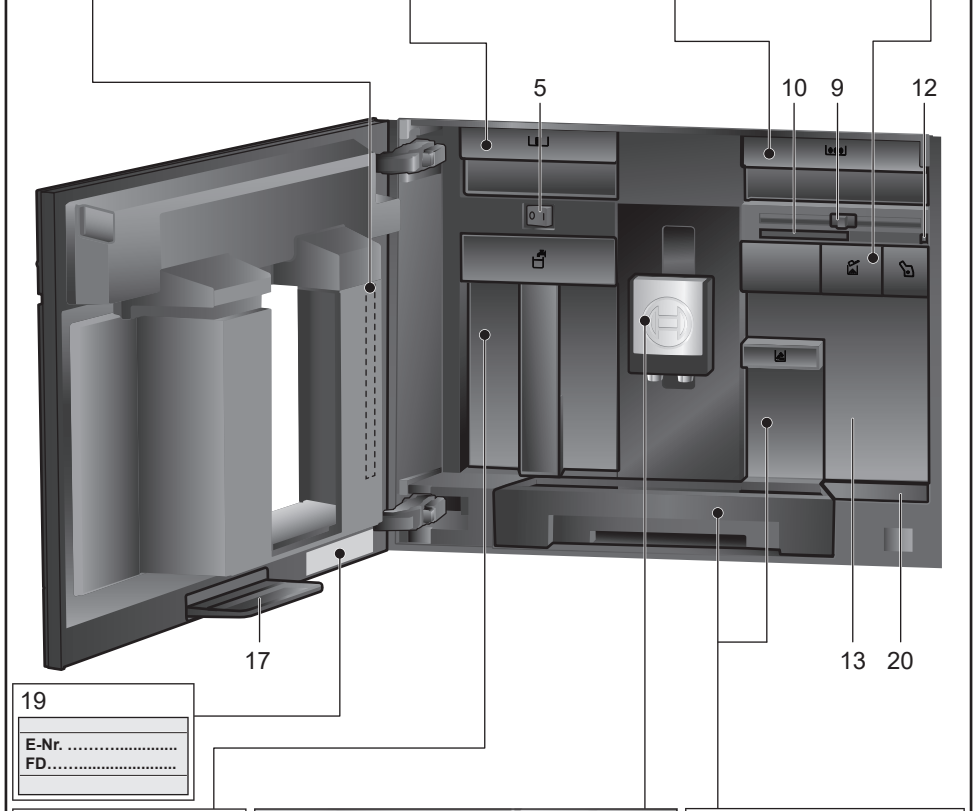
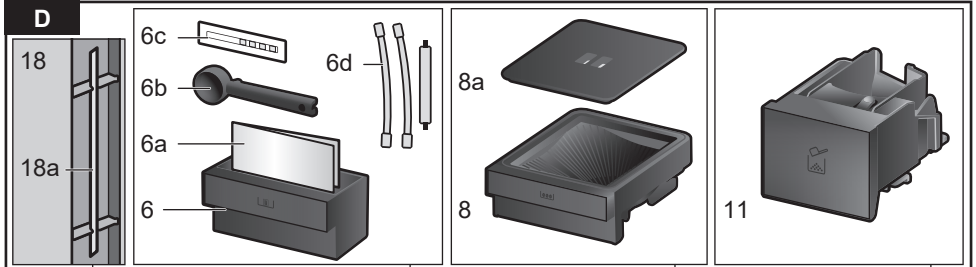

E

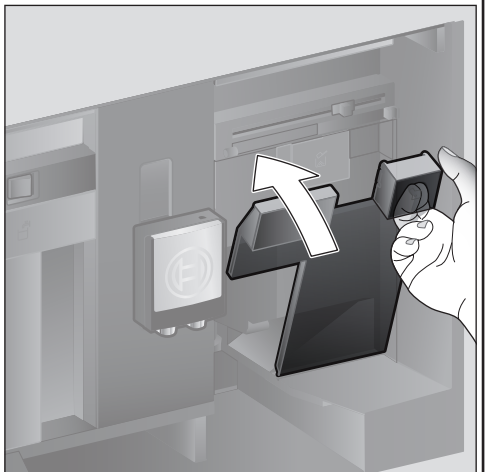
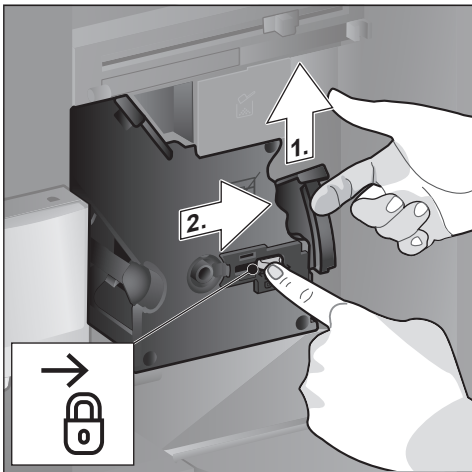
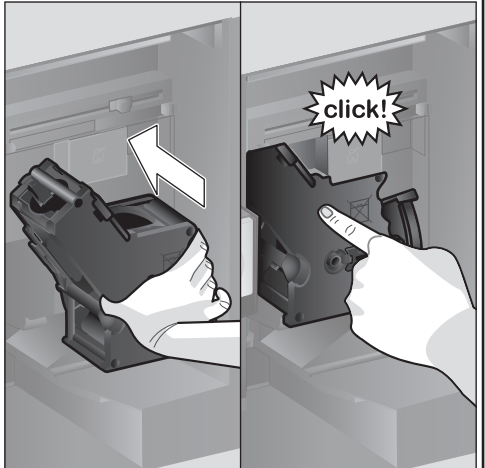
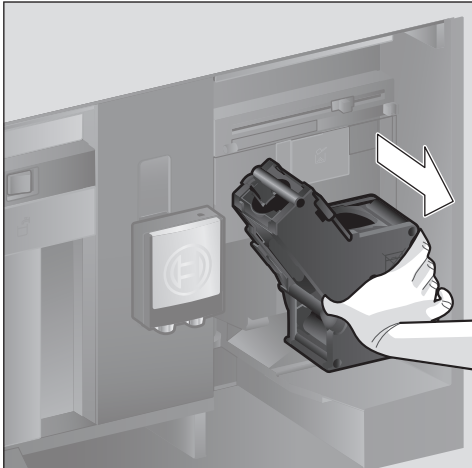
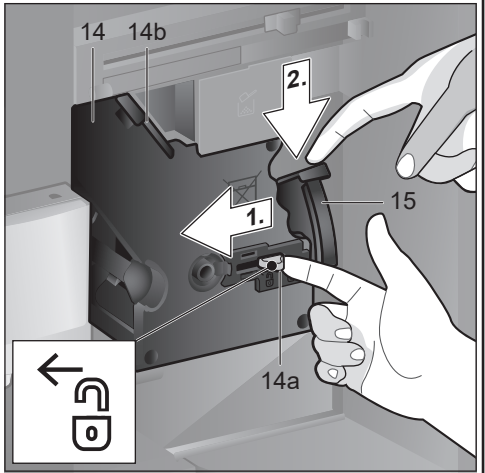
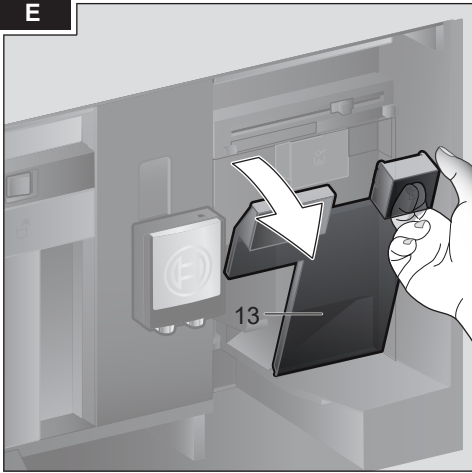

**内容**

供货范围 (使用专用) .....	6
感谢您 .....	7
使用范围 .....	8
重要安全须知 .....	8
概览 .....	10
操作控件 .....	10
启用 .....	11
操作面板 .....	12
饮料制备 .....	12
使用咖啡豆制备 .....	14
制备添加牛奶的咖啡 .....	15
使用预磨咖啡粉制备 .....	15
制备热水 .....	16
个性化饮料 .....	16
设置研磨度 .....	17
儿童安全锁 .....	17
菜单 .....	17
Home Connect .....	19
维护和日常清洁 .....	21
保养程序 .....	23
节能秘诀 .....	25
防冻保护 .....	25
存放附件 .....	25
附件 .....	25
废弃物处理 .....	25
保修 .....	25
简单故障排除 .....	26
技术数据 .....	28

**供货范围 (使用专用)**

(参见图 A)

- a** 全自动咖啡机
- b** 使用说明书
- c** 快速指南
- d** 咖啡勺
- e** 水硬度检测试纸
- f** 配有牛奶软管(套)
- g** 牛奶盒
- h** 牛奶软管

## 感谢您...

...购买本台全自动咖啡机!您获得了一台高质量、现代化的厨房设备。以创新科技研发而成,功能丰富而又操作简单。它可以为您迅速冲泡出一杯杯香醇可口的热饮,无论是浓烈的意式浓缩咖啡、绵密的卡布其诺、柔顺的拿铁玛奇朵或牛奶咖啡,还是传统的咖啡。同时,咖啡机还提供了许多附加功能,让您依据个人喜好冲泡个人化咖啡。

为确保您能可靠和安全地使用此全自动咖啡机的所有操作和功能,请您务必熟悉咖啡机所提供的各项组件、功能、显示以及操作控件。此说明书将帮助您了解本机。请花些时间阅读使用说明书再开机。

主要技术参数:

额定电压范围:220V-240V~

额定频率范围:50-60Hz

额定功率:1600W

原产地:斯洛文尼亚

总经销商:博西家用电器(中国)有限公司

地址:南京市中山路129号中南国际大厦

20、21楼

执行标准:

GB 4706.1-2005

家用和类似用途电器的安全 第1部分:通用要求

GB 4706.19-2008

家用和类似用途电器的安全 液体加热器的特殊要求

GB 4706.30-2008

家用和类似用途电器的安全 厨房机械的特殊要求

## 使用本说明书

您可以在本说明书的第一页查找本机构造图与标示数字,并可反复地参照。

例如:酿造装置(15)

本手册中也同样提供显示屏的显示和符号。所以,您可以认出在机器上或说明书上所显示相关的文字或符号。

显示屏上的显示:“浓缩咖啡”

显示屏上的按键和操作控件: [ ▷ ]

另有一份快速指南,帮助您迅速查找到最重要的功能。快速指南收在机器的附件收放处。

全国统一客户服务热线:4008855888

服务邮箱:careline.china@bshg.com

---

## 使用范围

本设备规定只可用于私人家庭和家用环境。

仅限在室温及海拔 2000 米以下的室内使用机器。

---

## 重要安全须知

请仔细阅读使用说明书,并保存本说明书以备以后使用!机器转让给他人使用时,请将本说明书一并转让。

凡年满 8 岁的儿童,身体、感官或智力有缺陷的人士以及缺乏相关经验和知识的人士,应在负责安全使用机器人员的监督或指导下,了解使用机器可能带来的危险后,方能使用本机。本机非供儿童使用,请勿让 8 岁以下的儿童靠近本机和连接电线。严禁儿童将本机用于嬉戏。年满 8 岁的儿童必须在监督下,方能对本机进行清洁或保养。



### **警告** **有电击危险!**

- 本机仅能通过按规定的接地插座与带交流电的供电系统相连接。请您确保,建筑内已按规定安装电气接地系统。
- 仅限按照铭牌上的说明连接和操作本机。
- 电线和机器必须完好无损方可使用。
- 机器修理事宜仅由我们的客户服务进行,才能避免危险发生。
- 若本机的电源线损坏,请务必更换由我们客户服务所提供的特定电源连接线。
- 请勿将机器或电线浸泡在水中。
- 故障发生时,请立即拔下电源插头或关闭电源电压。

### **警告** **磁性引起的危险!**

本机含有永久磁铁,会对心脏起搏器或胰岛素泵等电子植入物造成影响。请本身载有电子植入物的人距机器前至少保持 10 厘米以上的距离。

### **警告** **窒息危险!**

- 请勿让儿童用包装材料玩耍。
- 请妥善保管小零件,以避免吞食。

### **警告** **受伤危险!**

- 请勿将手伸入研磨机内。
- 关闭门时,请注意手指。
- 不当使用本机可能会导致受伤。

### **警告** **烧伤危险!**

- 饮料出口很烫。使用后应先让其冷却,然后才能触摸。

### **警告** **烫伤危险(Home Connect)!**

无人看守的情况下进行远程开启时,若有人在饮料流出期间触摸咖啡出口下方,可能造成第三方烫伤的危险。因此,在无人看守的情况下进行远程开启时,请确保不会对他人,尤其是儿童,或者对财物造成危险。

**注意:**如果电源软线损坏,为了避免危险,必须由制造商、其维修部或类似部门的专业人员更换。

## 概览

(参见图 B 至 E)

- 1 机门
  - a 隐藏式把手(开启机门)
  - b 搁板
- 2 操作控件(参见下页)
  - a 功能选择钮
  - b 信息显示屏
  - c 触摸屏(左和右)
- 3 出口系统(咖啡、牛奶、热水),可调高度
  - a 出口防尘盖
- 4 加奶系统
  - a 锁杆
  - b 饮料出口(上部、下部)
  - c 导奶管(2套)
  - d 连接件,金属(用于磁架)
- 5 电源开关 [O/I](电源)
- 6 附件收放处  
(用于快速指南和附件)
  - a 快速指南
  - b 咖啡勺
  - c 水硬度检测试纸
  - d 配有牛奶软管(套装)
- 7 分离式水箱
  - a 水箱盖
- 8 分离式咖啡豆箱
  - a 咖啡豆箱盖
- 9 咖啡豆研磨细度设置滑块
- 10 磁架(用于连接件)
- 11 分离式粉剂抽屉  
(咖啡粉/清洁剂)
- 12 固定件(用于导奶管)
- 13 保护盖(用于酿造装置)
- 14 酿造装置
  - a 装置锁
  - b 出口防尘盖
- 15 弹出控制杆
- 16 滴水盘(可取出)
  - a 滴水盘盖
  - b 咖啡渣盒
- 17 水滴托盘
- 18 固定件
  - a 牛奶软管
- 19 规格铭牌(机器型号;序号)
- 20 带有传感器的搁架(用于牛奶盒)

## 21 牛奶盒

- a 不锈钢牛奶盒
- b 盖子下部
- c 盖子上部

**i** 关于机器更多的信息,例如如何改变机门打开角度等问题,请参见随附的安装说明书。

## 操作控件

为了使操作机器尽可能的简单,同时提供各种功能的操作,该机器配有容易让人理解的菜单控件。可从各种可能的操作方法上,选择最少的操作步骤。

### 电源开关 [O/I]

使用电源开关 [O/I](打开机门)可将机器开启或完全关闭(电源断开)。

**i** **重要:**操作过程中,请勿触按电源开关。机器若在节能模式下会先关机,从而进行自动清洗。

### 操作面板(触控区)

**i** **重要:**本使用说明书介绍各种操作模式。某些机型上有 [⓪] 和 [▷] 的触摸屏控件。

### [⓪] 开/关

触按 [⓪],开启机器或进入节能模式。该机器将自动清洗。

机器无法进行清洗,原因是:

- 仍在开机等待暖机的状态。
- 关机前未冲泡咖啡。

机器一旦准备就绪,就会在显示屏上显示饮料选项的符号。

### [▷] 启动/停止

触按 [▷],启动饮料制备或保养程序。

再次触按 [▷],可在饮料制备过程中将程序提前中断。

控制面板有四个可通过触按选中的菜单字段。选中的菜单将亮起红色。

### [□]

一旦 [□] 亮起,便可操作机器。可以选择并冲泡饮料或更改饮料的设置。

### [☒] MyCoffee(我的咖啡键)

触按 [☒],调出所选的“个性化的饮料制备”。个人设置的咖啡饮料可以保存并检索(参见“个性化饮料”章节)。

**[] 菜单**

触控 [], 调出菜单。可以进行设定、检索信息或将电器连接到“Home Connect”(参见“菜单”章节)。

**[] 保养**

触控 [], 调出所选的保养程序。执行所需的程序, 如“保养程序”章节所述。

 再次触控 []、[] 或 [], 退出相应的菜单。

**功能选择钮**

旋转功能选择钮, 可在显示屏上进行浏览或将参数进行更改。

**信息显示屏**

全方位的显示屏将显示所选的饮料、设置或信息。

**触摸屏(左和右)**

两个触摸屏会根据设置显示不同的字段。触控并选中一个字段, 可进行设置或更改数值。

## 启用

### 概述

仅限使用无碳酸的干净冷自来水, 然后将烘焙过的咖啡豆放入相应的咖啡豆箱内。请勿使用非常油、上了焦糖或加了含糖添加物的咖啡豆, 因为这类咖啡豆容易阻塞酿造装置。

 本机必须根据随附的安装说明书正确安装并连接, 然后才能开机及操作。

### 启动机器

- 移除保护膜。

 **重要信息:** 仅能在无霜冻的地区使用本机。若在低于 0°C 的温度运输或存放本机, 应等待至少 3 小时再使用。

- 请握住并打开机门的隐藏式把手。
  - 取下水箱、清洗并倒入干净的冷水至“max”(最高)标记处。
  - 再将水箱装回直到卡紧入位。
  - 取出水箱, 倒入咖啡豆, 然后装回。
  - 将电源开关调至 [I], 然后关闭机门。
- 本机执行清洗及加热。  
激活操作面板。

显示“语言”。

- 请用手旋转功能选择钮, 选择所需的语言, 并触控字段 [水硬度]。

 水硬度的正确设置很重要, 能够使机器及时显示需要除垢的时间。预设的水硬度等级是 4, 若家中有安装软水器, 请调整水硬度至等级 3。请向当地供水单位查询水硬度。

- 或者, 您可以使用随机附送的试纸, 测试水的硬度。将此试纸快速浸入饮用水一下, 约一分钟后, 试验结果将显示出来。

等级	水硬度等级	
	德国(°dH)	法国(°fH)
1	1-7	1-13
2	8-14	14-25
3	15-21	26-38
4	22-30	39-54

- 左侧显示 [Home Connect] 以及右侧显示 [设置完成]。
- 触控 [Home Connect], 电器现在连接到无线网络(家庭网络)。
- 触控 [设置完成], 电器稍后将连接到无线网络。语言和水硬度的设定已保存。

 选择 [Home Connect] 时, 请阅读“Home Connect”章节内的详细说明。

机器已准备就绪, 一旦饮料符号显示, [☐] 将亮起。

每次冲泡饮料时, 内置风扇会自动开启, 数秒钟后又自动关闭。

机器于第一次使用、执行保养程序后或者长时间未使用时, 第一杯饮料完全不具香味, 请勿饮用。

启动自动咖啡机后, 将在冲泡数杯之后, 才会有厚实而稳定的咖啡油脂。

### 关机

- 触控 []。
- 机器自动清洗并进入节能模式。

**例外:** 仅有冲制热水, 才无需清洗直接关机。

- 为了完全关闭本机, 请将机门打开, 并将电源开关调至 [O]。

 **重要:** 操作过程中, 请勿触控电源开关。若机器在节能模式下, 会先关机, 从而进行自动清洗。

**i** 本台全自动咖啡机的各项出厂设置均为呈现最佳性能而设计。机器在所选的时间后，将自动进入节能模式并进行清洗（时间可调整，参见“自动待机时间”，位于“菜单”章节）。

机器配有传感器。若有牛奶盒，转为节能模式时会在显示屏上出现相应的显示。若有牛奶在牛奶盒中，请放入冰箱保存。

## 操作面板

操作面板是用于显示信息或通过触摸显示屏以及旋转功能选择按钮进行设置。

### 显示

操作面板上，将显示可选择的饮料、各种设置和设置内容以及回报现阶段正在进行的动作。





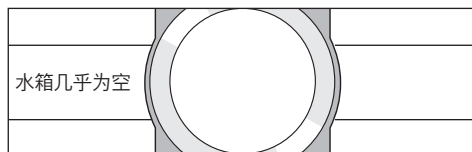

例如饮料选项



例如信息



在您操作机器或一段时间后，信息就会消失。而该信息在信息显示上以一个小符号的形式保留。

-  豆箱几乎为空
-  水箱几乎为空
-  更换过滤器
-  紧急执行清洁程序
-  紧急执行除垢程序
-  紧急执行钙化清洁程序

## 处理的需求

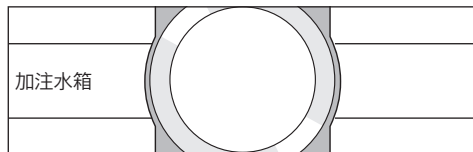

**i** 一旦您采取动作，例如将水箱注水，相应的信息和符号再度消失。

## 操作

触摸操作面板上的文字或符号，并配合旋转功能选择按钮进行浏览（相关范例请参见“调整饮料”章节）。

触摸触摸屏会发出响音。可打开或关闭讯号音（参见“菜单 - 按键音”章节）。

## 饮料制备

本台全自动咖啡机可以使用咖啡豆或研磨咖啡粉（非即溶咖啡）。

若使用咖啡豆，每次酿造皆为新鲜现磨的咖啡。为了获得最佳质量的咖啡豆，请将咖啡豆密封好并保存在阴凉处。

**i** **重要：**水箱应每天更换干净的冷水，请勿使用添加碳酸的水。保持足够的水量以维持机器的运作。

**秘诀：**请主要使用厚壁的小杯子，可用热水先预热。

在一些设置中，咖啡制备分成两步骤（参见“加倍香浓功能”以及“同时制备两份”章节）。请等待冲泡程序完成。

## 饮料选择

旋转功能选择按钮，可选择不同的饮料：

符号和所选饮料的名称将被显示在信息显示屏的中央。

咖啡浓度和咖啡温度等当前的设定值均显示在触摸屏的左右两侧。



**共有下列数种选择。**

- 超浓咖啡
- 浓缩咖啡
- 浓缩玛奇朵
- 奶油咖啡
- 卡布奇诺
- 拿铁玛奇朵
- 白咖啡
- 奶沫
- 温牛奶
- 热水

所选的饮料可直接使用预设值进行制备或预先调整到适合个人的口味。

**调整饮料**

触按触摸屏上所显示的字段,例如 [∅], 字段被选中后, [∅] 将显示为红色。

旋转功能选择钮更改设置。重新触按字段 [∅], 将设置保存。

**举例说明:**

您可以如下所示更改一杯“奶油咖啡”的值:

- 旋转功能选择钮, 选择“奶油咖啡”。

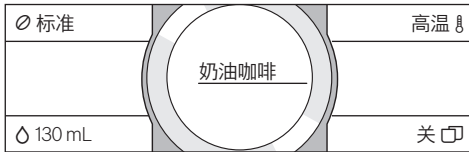

- 例如, 触按字段 [∅], 字段被选中后, [∅] 将显示为红色。

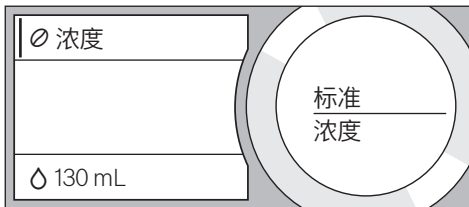

- 旋转功能选择钮, 然后在信息显示屏中央上设置所选的咖啡浓度, 例如调至“非常强”。

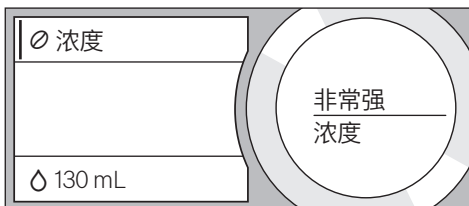

- 触按字段 [∅]。
- 旋转功能选择钮, 设置所需的咖啡量, 例如设置“160mL”。

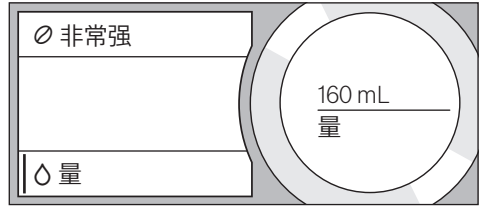

- 轻触字段 [∅]。
- 旋转功能选择钮, 设置所需的温度, 例如设置“极高温”。

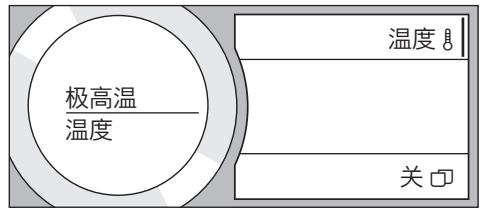

- 触按选中的字段或开始冲泡咖啡保存设置。



- i** 设置内容会根据饮料类型而不同。除牛奶仅能调整份量外, 可对咖啡饮料, 例如咖啡浓度、温度和咖啡量进行设置。

**选择以下的设置:****咖啡的浓度**

十分柔和  
柔和  
标准  
强  
非常强  
双倍浓缩咖啡  
双倍浓缩咖啡+  
双倍浓缩咖啡++

**加倍香浓功能**

咖啡酿造时间越长,释放出的苦味和意外异味越多。咖啡的味道和帮助消化的成分都因此受到影响。因此,本机对于浓度非常强的咖啡有加倍香浓的功能。制备一半饮用量时,可将咖啡豆再次研磨并冲泡,释放出宜人的、帮助消化的香浓成分。

制备超浓咖啡、浓缩马琪朵以及研磨咖啡时不提供加倍香浓功能。

**份量**

份量会根据饮料种类而有所不同,请以 mL 步骤进行调整。



冲泡好的份量会根据牛奶的质量而有所不同。

**饮料温度**

咖啡饮料值:

标准  
高温  
极高温

热水值:

70°C 白茶  
80°C 绿茶  
90°C 红茶  
最高温 水果茶



若 30 秒左右没有操作机器的动作,本机将自动退出设置状态。所做的设置将自动保存。

**同时制备两份**

触按 [  ], 可同时制备两份所选的饮料。例如,设置将显示如“2x 浓缩咖啡”的字段。

■ 触按 [  ]。

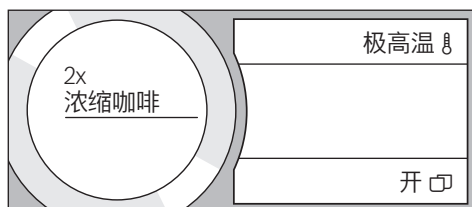

■ 在饮料出口下左右两侧各放置一只杯子。

■ 触按 [  ], 开始冲泡。

所选择的饮料制备好后随即流入杯内。



咖啡分两步骤制备(两次研磨过程)。请等待冲泡程序完全结束。

“加倍香浓功能”或“咖啡粉”的设置无法提供同时制备两份。

**使用咖啡豆制备**

机器必须开启。

■ 将杯子放置在饮料出口下方。

■ 旋转功能选择钮,选择“超浓咖啡”、“浓缩咖啡”或“奶油咖啡”。

显示屏上将显示所选的饮料以及该饮料的预设值。



可更改设置,如“调整饮料”章节所述。

■ 触按 [  ], 开始冲泡。

咖啡酿造好后随即流入杯内。

再次触按 [  ], 可将程序提前中断。

## 制备添加牛奶的咖啡

本台全自动咖啡机具有一个内置的饮料出口。因此,可以制备添加牛奶的咖啡饮料或奶沫以及温牛奶。



### 烧伤危险!

饮料出口很烫。使用过后,应先让其冷却,然后才能触摸。

## 牛奶盒

该牛奶盒是为了与此台全自动咖啡机一起使用而研发。仅供家用,并可将牛奶存放在冰箱里。隔热效果的牛奶盒能够将牛奶冷藏数小时。



**重要:** 请将杯子或玻璃杯移开,才能开启机门,否则可能会倾倒。

连接牛奶容器或牛奶盒:

- 打开机门。
- 将饮料出口的防尘盖向前取下。
- 连接并固定导奶管和连接件,如图所示。

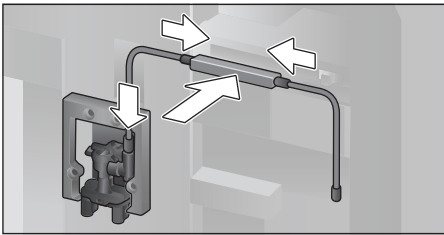

- 从前面将饮料出口的防尘盖装回固定。
- 将牛奶软管插上固定,并将另一头插入牛奶容器或牛奶盒。

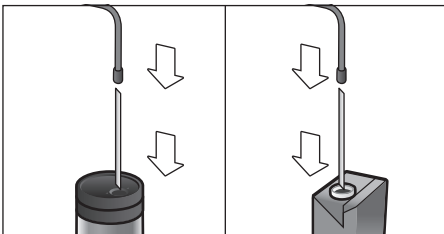

- 关上机门。



干燥凝固后的牛奶残渣非常难清除,因此**务必在每次使用后**清洗(参见“清洁加奶系统”章节)。

## 制备添加牛奶的咖啡

- 将杯子或玻璃杯放置在饮料出口下方。
- 旋转功能选择钮,选择“浓缩玛奇朵”、“卡布奇诺”、“拿铁玛奇朵”或“白咖啡”。显示屏上将显示所选的饮料以及该饮料的预设值。



可更改该设置,如“调整饮料”章节所述。

- 触控 [▷],开始冲泡。
- 牛奶先会流入杯子或玻璃杯内。然后酿造好的咖啡随即再流入杯子或玻璃杯内。
- 再次触控 [▷],可将程序提前中断。

## 奶沫或温牛奶

- 将杯子或玻璃杯放置在饮料出口下方。
- 旋转功能选择钮,选择“奶沫”或“温牛奶”。



可更改该设置,如“调整饮料”章节所述。

- 触控 [▷],开始冲泡。
- 奶沫或温牛奶从饮料出口流出。
- 再次触控 [▷],可将程序提前中断。

## 使用预磨咖啡粉制备



使用预磨咖啡粉制备时,无法提供咖啡浓度和同时制备两份的设置。

**重要:** 请将杯子或玻璃杯移开,才能开启机门,否则可能会倾倒。

机器必须开启。

- 打开机门。
- 取出粉剂抽屉。粉剂抽屉应保持干燥。
- 将预磨咖啡粉倒入粉剂抽屉内(最多两平匙),勿压平。



### 注意!

请勿添加咖啡豆或即溶咖啡在粉剂抽屉内。

- 插入粉剂抽屉。
- 关上机门。



若在 90 秒内没有冲泡咖啡的动作,酿造装置会自动排空,以免加注过量。清洗机器。

- 将杯子放置在饮料出口下方。
- 旋转功能选择钮,选择咖啡饮料或有添加牛奶的咖啡饮料。

显示屏将显示所选的饮料、咖啡粉勺以及饮料的预设值。



**i** 可更改该设置,如“调整饮料”章节所述。

请注意位于“制备添加牛奶的咖啡”章节内关于咖啡饮料添加牛奶的注意事项。

■ 触控 [▷],开始冲泡。  
咖啡酿造好后随即流入杯内。选择添加牛奶的咖啡饮料时,牛奶先会流出,然后是酿造好的咖啡。

**i** 若继续使用研磨咖啡粉冲泡咖啡,请重复操作步骤。

## 制备热水

**⚠ 烧伤危险!**  
饮料出口很烫。使用后应先让其冷却,然后才能触摸。

机器必须开启。

- 请将牛奶盒的导奶管取下。
- 请清除出口处的牛奶或咖啡残渣。
- 将杯子或玻璃杯放置在饮料出口的下方。
- 选动功能选择钮,然后选择“热水”。

**i** 该设置如章节“调整饮料”所述,可以进行更改。

- 触控 [▷],开始冲泡。
- 若侦测到牛奶盒仍在机器上,将会显示以下的信息:“已从牛奶盒上拆下导奶管?”。
- 若导奶管仍然连接,请取下,然后触控显示屏幕上的 [是]。

热水从饮料出口流出。

再次触控 [▷],可将程序提前中断。

## 个性化饮料

触控 [☞],打开个性化饮料选项。  
可使用多达 8 种不同的存储位置。此处存储个人偏好经常冲泡的饮料连同其所有的设置。

**i** 触控 [☞],可随时退出菜单,不用进行保存。

## 创建或更改饮料

- 触控 [☞]。显示存储位置选项。
- 旋转功能选择钮,选择一个空的存储位置(空玻璃杯)进行创建或将已存在的存储位置进行更改或将个人偏好的饮料进行删除。
- 创建空的存储位置时,请选择 [新的],或将已存在的存储位置进行更改时,请选择 [详情]。

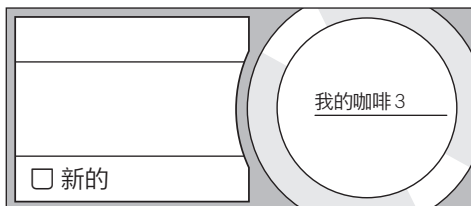

显示饮料调整的菜单。将显示上次冲泡的饮料连同上次所选择的设置。

- 若无存储上次的饮料,请旋转功能选择钮,然后选择另外的饮料。
- 每次请触控欲更改的设置,旋转功能选择钮,然后依个人喜好调整数值。

根据选项显示其它的设置内容。

- 触控 [更多详情 | 保存],继续其他设置。

**i** 对于添加牛奶的饮料,可设置咖啡和牛奶的混合比例。

- 该设置可以个人名称保存。触控 [名称]。显示名称输入的屏幕窗口。

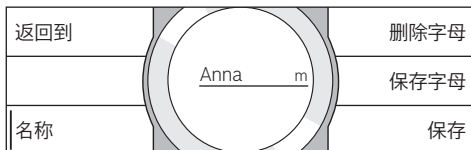

- 旋转功能选择钮,选择字母或符号。
- 触控 [保存字母] 确定所择的字母或触控 [删除字母] 进行删除。
- 选择并确认其他字母或符号。
- 触控 [保存] 保存输入的资料。显示选项菜单。
- 触控 [☞],退出菜单。

## 删除饮料

- 触控 [☞]。
- 旋转功能选择钮,选择已存在的存储位置。
- 触控 [详情] 和 [更多详情 | 保存]。
- 触控 [删除饮料],然后触控 [删除]。存储位置重新可用。



## 选择并冲泡个性化饮料

- 触控 [☒]。显示存储位置选项。
- 旋转功能选择钮,选择所需的存储位置。
- 将杯子或玻璃杯放置饮料出口下方。
- 触控 [▷],开始冲泡。

## 设置研磨度

此台全自动咖啡机具有可调式研磨器。因此可依据各人喜好,更改咖啡研磨度。

- 打开机门。
- 使用滑块在研磨度细的咖啡 ☼ 和研磨度粗的咖啡 ☼ 之间选择设置研磨度。

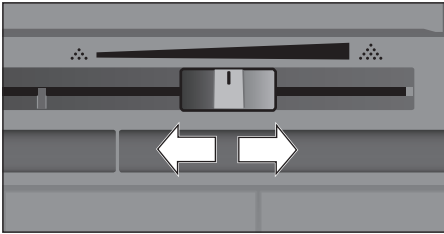

- 再度关上机门。

**i** 深色烘焙的咖啡豆适合磨细一点,浅色烘焙的咖啡豆才适合较粗的研磨度。

**秘诀:** 研磨度的设置仅需小幅度更改。新的设置在第二杯咖啡后才会变得明显。

显示屏显示信息“选择较粗的研磨度”代表咖啡研磨度太细。设置较粗的研磨度。

## 儿童安全锁

为了防止儿童烫伤和烧伤,可将机器锁定。

- 请触控 [🔒] 至少 4 秒。显示屏短暂显示“启用儿童安全锁”。这时机器无法再进行操作,只有触控 [🔒] 才能进行操作。
- 触控 [🔒] 至少 4 秒,将儿童安全锁停用。显示屏短暂显示“儿童安全锁已停用”。

## 菜单

您可依个人喜好,在菜单中更改您的设置、检索信息或开始程序。

- 触控 [🔑],打开菜单。触摸屏将显示各种设置内容,全息显示屏显示当前的设置。

## 菜单浏览:

例如,触控语言,选中相应的设置,并以红色突出显示。

旋转功能选择钮,选择设置例如“简体中文”。触控 [其它],显示其它设置内容。

语言		照明
水硬度		照明亮度
自动待机时间		其它>

### 举例说明:

设置机器在 15 分钟后自动关闭:

- 触控 [🔑]。菜单将打开。
- 触控 [自动待机时间],该字段用红色突出显示。
- 旋转功能选择钮,选择“00h15m”。
- 触控 [🔑]。显示 [保存] 和 [不保存]。
- 触控 [保存]。机器将保存该设置。显示屏显示饮料选项。

**i** 触控 [🔑],可在任何时候退出菜单。若约 30 秒无任何输入动作,机器将自动关闭菜单,将不保存该设置。

### 可进行以下的设置:

语言

在语言设置上显示所需显示的文字。

水硬度

设置当地的水硬度。

可选择从“1(软)”到“4(极硬)”的等级。预设的水硬度等级为“4(极硬)”。

**i** 正确设置水硬度非常重要,这样机器才能适时显示何时应进行除垢程序。

您可以使用随机附送的试纸测试水的硬度或咨询当地的供水单位。若家中有安装软水器,请设置“软水装置”。

过滤器

若需要插入、更换或拆下过滤器,必须在菜单上相应设置“插入”、“更换”或“拆下”过滤器。

**i** 过滤器可避免钙化,减少水中杂质,进而提高咖啡风味。过滤器可经由经销商或客户服务订购(参见“附件”章节)。

插入或更换过滤器:

使用新的过滤器之前,应先将过滤器清洗。

- 转动功能选择钮,选择“插入”或“更换”。

- 将过滤器压入水箱凹槽中固定。

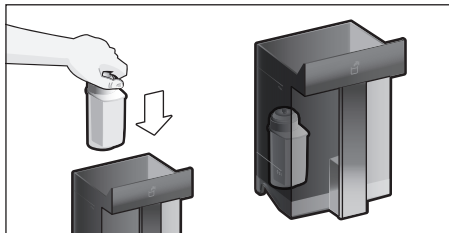

- 给水箱加水至“max”(最高)标记处。
- 取下牛奶盒的导奶管,然后关上机门。

**i** 注意:关上机门时,机门不得夹住导奶管。

- 将一个 0.5 升的容器放在饮料出口的下方。
- 触按 [▷] 确定。这时水流经过滤器,并对其进行清洗。
- 然后倒空容器。机器可再次使用。

**i** 清洗过滤器的同时会开启更换过滤器的显示设置。

出现“更换过滤器”信息时或最迟两个月后,过滤器的作用已经耗尽。出于卫生考虑,需要更换过滤器,以防止机器出现水垢沉积(这可能损坏机器)。

- 若无新的过滤器插入,请选择设置“拆下”,然后触按 [▷] 确定。

显示“拆下过滤器,重新插入水箱,关闭门”。

**i** 若机器已有很长时间未使用(例如外出度假),第一次使用前,请清洗使用中的过滤器。方式是冲制一杯热水即可。

您可在随附的过滤器说明中找到关于过滤器的详细信息。

## Home Connect

用于连接到无线网络(家庭网络)和移动设备的设定(参见“Home Connect”章节)。

## 自动待机时间

设置机器在冲泡最后一杯咖啡后,经过多久可自动清洗并关闭的时间。

可选值是从 15 分钟到 8 小时。预设的时间是 30 分钟。

## 照明

设置饮料出口的照明。可选择“开”、“使用时”或“关”。

## 照明亮度

设置饮料出口的照明亮度。可选的等级从“等级 1”到“等级 10”。

## 显示屏亮度

设置显示屏亮度

## 按键音

开或关讯号音。

## 时钟显示

时间“关”或“数字”(开)的显示内容。可在菜单选项上进行设置时间。

**i** 使用电源开关关闭机器或电源发生故障时,时间的设置会丢失。

## 时间

设置当前的时间。

## 防冻功能

机器的保养程序是避免运输或存放时遭受霜冻的损害。

进行此程序时,请完全清空机器。

- 清空并再次插入水箱。
- 必要时取下牛奶盒,然后关闭机门。机器自动清空管道系统。
- 请清空并插入滴水盘。

## 饮料信息

显示机器启用至今制备多少饮料。

## 出厂设置

您可以取消您的个别设置,回到出厂设置状态。

- 触按 [复位] 确定或使用 [不复位] 中断。

## Home Connect

本台咖啡机具有 Wi-Fi 功能, 并可通过移动设备(例如平板电脑、智能手机)进行远程遥控。Home Connect App 所提供的附加功能与网络电器相得益彰。

若电器未连接到无线网络(家庭网络), 它的功能就像一般没有网络连接的咖啡机, 还是可以一如往常通过显示屏进行操作。

**i** 若您出门在外并通过 Home Connect App 进行操控时, 请注意本说明书一开始的安全注意事项并确实遵守。请同时遵守在 Home Connect App 的注意事项。

电器上的操作在任何时候都优先进行, 这段期间无法通过 Home Connect App 进行操控。

### 设定

为了能够通过 Home Connect 进行设定, 请将 Home Connect App 安装在移动设备(例如平板电脑、智能手机)上。遵守随附的 Home Connect 使用说明。请按照 App 所指定的步骤进行设定。咖啡机初始启动时可直接登录无线网络或通过菜单(先触控 [  ], 打开菜单)完成:

- 触控 [Home Connect]。
- 触控 [Wi-Fi], 开始无线连接。显示屏显示“开Wi-Fi”。
- 触控 [連接網絡]。显示选项 [自動連線] 和 [手動連線]。

**i** 若控制器有 WPS 功能, 请选择 [自動連線]。

### 自动连接到无线网络(家庭网络)

- 触控 [自動連線]。显示屏上显示 [網絡自動連線]。
- 请在数分钟内按下家庭网络控制器上的 WPS 按钮, 直到咖啡机的显示屏显示“網絡連線成功”。
- 打开移动设备上的 App。
- 触控 [與 app 連線]。本台咖啡机自动连接到 App。
- 请等到显示屏上 [與 app 連線 成功] 短暂亮起。
- 触控 [远程启动]。出现一条警告讯息。
- 触控 [其它] 并读取警告讯息。
- 触控 [确认]。

现在利用移动设备, 可以通过 App 对咖啡机的全部功能进行操控。

**i** 选择远程开启: [停用]时, 将只在 Home Connect App 上显示咖啡机的运作状态。可以进行设定, 但不启动任何饮料制备。

### 手动连接到无线网络(家庭网络)

- 触控 [手動連線]。本台咖啡机将创建一个自有的无线网络, 可以通过平板电脑或智能手机进行访问。显示屏将显示此网络的 SSID(名称)和 Key(密码)。
- 移动设备将以 SSID “HomeConnect” 和 Key “HomeConnect” 登录咖啡机网络。
- 启动移动设备上的 App, 并遵照 App 上网络登录的指示和随附的 Home Connect 说明。

若显示屏上“網絡連線成功”短暂亮起, 登录过程才算完成。

- 触控 [與 app 連線]。此外, 应打开移动设备上的 App。本台咖啡机连接到 App。
- 请等到显示屏上 [與 app 連線 成功] 短暂亮起。
- 触控 [远程启动]。出现一条警告讯息。
- 触控 [其它] 并读取警告讯息。
- 触控 [确认]。

现在利用移动设备, 可以通过 App 对咖啡机的全部功能进行操控。

**i** 选择远程开启: [停用]时, 将只在 Home Connect App 上显示咖啡机的运作状态。可以进行设定, 但不启动任何饮料制备。

### 开启与关闭 Wi-Fi

可视需求将 Wi-Fi 切换为“开”或“关(例如度假时)。”

**i** 电器关闭后仍将保留网络信息。开启数秒钟后, 请等到咖啡机重新连接到无线网络。

本电器在联网待机模式下最大需要 2 W。

- 触控 [  ], 打开菜单
- 触控 [Home Connect]。
- 触控 [Wi-Fi], 切换无线模式为“开”或“关”。

## 其它设定

Home Connect 可以随时根据个人需求进行调整。

注意:本台咖啡机应连接到无线网络。

### 断开连接

本台咖啡机可以随时断开与无线网络的连接。



若咖啡机断开与无线网络的连接,便无法通过 Home Connect 进行任何操控。

- 触按 [☞], 打开菜单。
- 触按 [Home Connect]。
- 触按 [断开网络]。

断开网络和 App 的连接。Wi-Fi 和远程开启已关闭。



有关无线网络的信息将被删除。

### 连接到 App

可在任意数位移动设备上安装 Home Connect App,并连接到咖啡机。

本台咖啡机必须已经连接到无线网络。

- 打开移动设备上的 App。
- 触按 [☞], 打开菜单
- 触按 [Home Connect]。
- 触按 [與 app 連線], 本电器将连接到 App

### 远程开启

例如,若要通过移动设备在咖啡机上启动饮料制备,应激活远程开启。



#### 烧伤危险!

无人看守的情况下进行远程开启时,若有人在饮料流出期间触摸咖啡出口下方,可能造成第三方烫伤的危险。因此,在无人看守的情况下进行远程开启时,请确保不会对他人,尤其是儿童,或者对财物造成危险。



与 Home Connect 成功完成连接后,只有在文本框才能看见 [远程启动]。

若关闭远程开启,只能在 Home Connect App 显示咖啡机的运作状态。

- 触按 [☞], 打开菜单
- 触按 [Home Connect]。
- 触按 [远程启动], 切换远程开启功能为“开”或“关”。

## 电器信息

网络和电器信息显示

- 触按 [☞], 打开菜单
- 触按 [Home Connect]。
- 触按 [电器信息]。将显示 SSID、IP、MAC 位址和本电器的序号数秒钟。

## 数据保护注意事项

本台咖啡机在第一次连接到与互联网相连的网络时,将传输咖啡机下列各类数据至 Home Connect 服务器上(首次注册):

- 唯一机器标识符(包括电器密钥以及已安装 Wi-Fi 通信模块的 MAC 位址)。
- Wi-Fi 通信模块的安全证书(信息技术的连接保障)。
- 本台咖啡机当前的软件和硬件版本。
- 将之前任何的状态恢复至出厂设置。

此首次注册是准备提供给 Home Connect 功能使用,并在您第一次使用 Home Connect 功能时,才会被使用。



请注意, Home Connect 功能只有在连接 Home Connect App 时才能使用。您可在 Home Connect App 中调出数据保护的相关信息。

## 符合性声明

罗伯特·博世家电有限公司(Robert Bosch Hausgeräte GmbH)在此严正声明,配有 Home Connect 功能的家电符合指令 1999/5/EC 的基本要求以及其他相关的规定。有关详细的 R&TTE 符合性声明,您可以在 [www.bosch-home.com/de](http://www.bosch-home.com/de) 您的家电产品页面中的其他文件查看相关信息。

## 维护和日常清洁



### 有电击危险!

请勿将机器浸泡在水中。请勿使用蒸汽清洁剂。

- 请使用湿软布擦拭外壳。
- 请以超细纤维布清洁控件。
- 请勿使用任何含酒精或苯的清洁剂。
- 请勿使用摩擦型清洁剂。

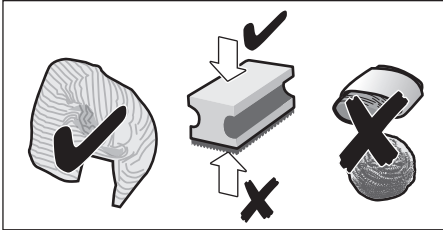

- 请立即去除水垢、咖啡、牛奶或清洁剂以及除垢液残留物。这些残留物会导致腐蚀。



新的海绵抹布可能黏附有盐。盐会导致不锈钢产生锈膜,所以在使用海绵前请彻底清洗。

- 打开机门,将滴水盘往前取下。
- 取下滴水盘盖和咖啡渣盒。
- 请清空、清洁以及晾干部件。



**重要:** 请每天清空并清洁滴水盘和咖啡渣盒,防止污垢堆积。

- 取出粉剂抽屉,并用水冲洗,然后晾干。

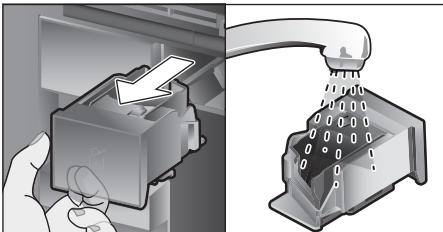

- 请擦拭并晾干机器内部(滴水盘和粉剂抽屉)及水滴托盘。
- 请装上晾干的部件,例如粉剂抽屉。



### 以下部件请勿放入洗碗机洗涤:

附件盒、水箱、水箱盖、饮料出口防尘盖、咖啡豆箱、咖啡豆箱盖、连接件的金属、粉剂抽屉、酿造装置保护盖、酿造装置以及牛奶盒。



### 以下部件适合洗碗机洗涤:

搁板、水滴托盘、滴水盘、滴水盘盖、咖啡渣盒、导奶管、牛奶软管、单件饮料出口、咖啡勺以及单件牛奶盒盖。



若本机在冷状态下开启或在冲泡咖啡后关闭,机器将自动清洗。因此,系统将自行清洗。

**重要:** 若机器已有很长时间未使用(如外出度假),请将机器彻底清洗,包括加奶系统、粉剂抽屉以及酿造装置。

## 清洁加奶系统

制备添加牛奶的饮料后,将用短暂的空喷蒸汽自动清洁加奶系统。



**秘诀:** 可用水额外的彻底清洗加奶系统(参见“清洗加奶系统”章节)。

**重要:** 加奶系统应每周进行清洁,必要时也可以经常清洁(参见“手动清洗加奶系统”章节)。



### 烧伤危险!

饮料出口很烫。使用后应先让其冷却,然后才能触摸。

## 清洗加奶系统

- 触控 [☺]。
- 触控 [清洗加奶系统], 选择程序。
- 打开机门,将牛奶软管从牛奶盒上取下。
- 擦拭牛奶软管,并将牛奶软管的一端插入咖啡渣盒孔。

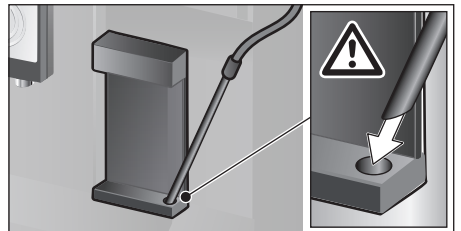

- 关上机门。这时,请勿卡住导奶管。
- 将空玻璃杯放置在饮料出口的下方。
- 触控 [▷] 确定。加奶系统将以水进行清洗。
- 然后倒空玻璃杯。
- 触控 [☺], 退出程序。

### 手动清洗加奶系统

将加奶系统拆卸清洗：

- 将饮料出口整个推至底部，并向前移开防尘盖。
- 按下饮料出口左侧的锁杆，便可将饮料出口向前拉出。

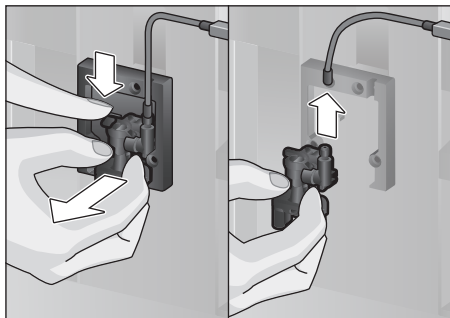

- 取下导奶管。拆卸饮料出口的上下部件。

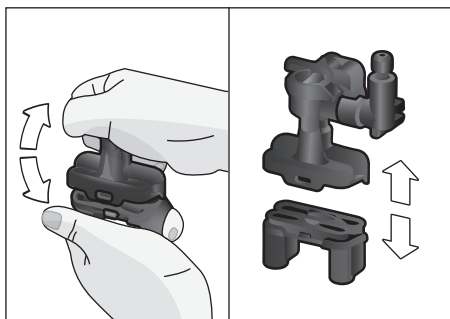

- 拆开导奶管、连接件以及牛奶软管。

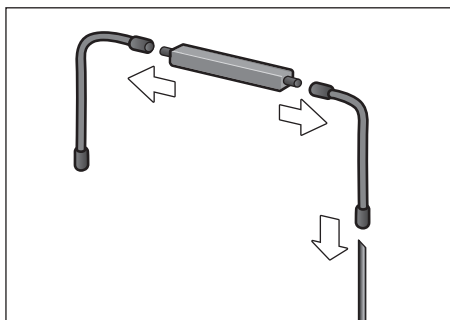

- 可使用洗涤液和软布清洁单件。
- 将所有的部件用清水洗净并晾干。



所有加奶系统的部件也可以放入洗碗机洗涤。

- 将各部件重新组装起来(另见快速指南)。

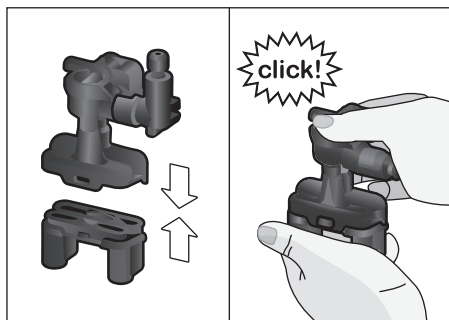

- 饮料出口直接从前面装回至三个接口固定。
- 重新装上防尘盖。

### 清洁加奶系统

出于卫生考虑，应定期清洁牛奶盒。仅有单件盖子可以放入洗碗机洗涤。请用手以温和的清洁剂清洗不锈钢牛奶盒。

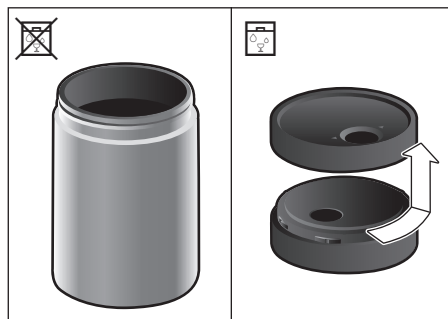

### 清洁酿造单元

(另见快速指南)

除了使用自动清洁程序外，也应定期将酿造装置取出清洁。

- 打开机门。
- 电源开关 [O/I] 可将机器完全关闭。
- 请将保护盖从酿造单元上取下。
- 取出咖啡渣盒。
- 将酿造装置上的红色装置锁整个向左推至 ☺ 的位置。
- 将弹出控制杆整个往下压。酿造装置将松开。
- 抓紧酿造装置的隐藏式把手，小心取下。



- 取下盖子,用水彻底冲洗酿造装置。

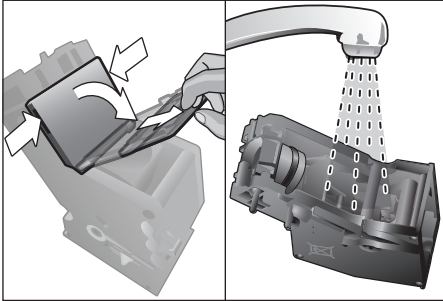

- 在水龙头下将酿造装置的过滤器冲洗干净。

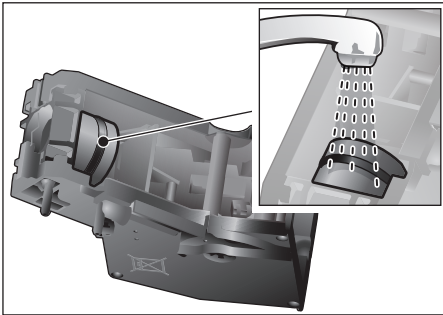

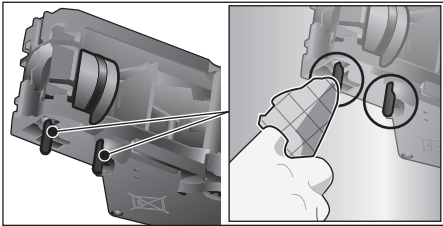

- 请彻底清洁酿造单元的连接销。



-  **重要:** 请勿用洗洁精清洗,也不得放入洗碗机洗涤。

- 请彻底地清洁机器内部,清除咖啡残留物。
- 让酿造装置和机器内部晾干。
- 请重新将防护盖盖在酿造单元上。
- 将酿造单元推回电器内,并按中央部位直至其卡紧为止。

-  **注意:** 红色装置锁应在安装前整个推到最左边  的位置(参见图 E)。

- 将弹出控制杆整个向上推,将红色装置锁整个向右推至  。
- 插上咖啡渣盒。
- 重新盖上防护盖。
- 关上机门。

## 保养程序

(另见快速指南)

显示屏会不定期地显示

“紧急执行除垢程序!”

或者

“紧急执行清洁程序!”

或者

“紧急执行钙化清洁程序!”。

此时应立即采取相应的程序,清洁机器或给机器除垢。您可通过钙化清洁程序,选择将除垢和清洁程序一起执行(参见“钙化清洁”章节)

。您可以随时启动保养程序,无需等到显示屏上出现提示信息,避免机器遭受损害。

-  **重要:** 若本机未正确除垢,将显示“除垢程序逾期 电器稍候将被锁定!”。请在出现提示后立即执行除垢程序。若本机被锁定,只能在完成除垢程序后重新操作。

为了显示还可以冲泡多少饮料,请在进行保养程序前,执行以下步骤:

- 触控  。

将显示保养程序。计数器提供了有关信息,例如“再过 28 杯需要执行除垢程序”,提醒您各个程序在下一次的执行时间。



### 注意!

请依照说明书上的指示,使用保养程序的除垢和清洁片剂,使用时请留意(相应)的安全注意事项。

切勿中断保养程序!

请勿饮用任何程序所产生的液体。

请勿使用醋、含醋、柠檬酸的产品或含柠檬酸的产品为您的机器除垢!

请勿将除垢片剂或其他除垢剂放入粉剂抽屉内!



### 重要:

开始各个保养程序前(除垢程序、清洁或钙化清洁程序),请将酿造装置取下,根据指示清洁并重新装上。关机门时,请勿卡住导奶管。

在完成每个保养程序后,请立即用柔软的湿布擦去除垢和清洗液的残留物。这些残留物会导致腐蚀。新的海绵抹布可能黏附有盐。盐会导致不锈钢产生锈膜,所以在使用海绵前请彻底清洗。请彻底清洁饮料出口、导奶管以及连接件。

**i** 专为这款全自动咖啡机而研发的除垢和清洁片剂，可由经销商和客户服务订购（参见“附件”章节）。

## 除垢程序

所需时间:约 21 分钟。

- 触控 [☉]。
- 触控 [除垢]，选择程序。
- 显示屏将带领您完成整个程序。
- 清空并重新装回滴水盘。
- 必要时，请取出过滤器，然后触控 [▷] 确定。
- 在空水箱中加入微温水至“0.5 升”的标记处，然后将两片除垢片剂00311556溶解在水中。

**i** 若水箱中的除垢溶液太少，将显示相应的要求。请倒入无碳酸的水，然后再次触控 [▷] 确定。

- 从牛奶盒中取下并擦拭牛奶软管，并将牛奶软管的一端插入咖啡渣盒孔。
- 关上门。
- 请将 0.5 升容量的容器放置在饮料出口的下方。
- 触控 [▷] 确定。除垢程序将运行大约 19 分钟。
- 请移开容器，然后触控 [▷] 确定。
- 清洗水箱，(必要时)请重新插入过滤器。
- 在水箱中加入干净的水至“max”(最高)标记处。
- 重新插入水箱，然后关上门。
- 将容器重新放置在饮料出口的下方。
- 触控 [▷] 确定。除垢程序将运行约 2 分钟，然后清洗机器。
- 取下容器、清空并重新插入滴水盘，然后关上门。
- 触控 [▷] 确定。除垢程序完成，机器可再使用。
- 触控 [☉] 退出程序。

## 清洁

所需时间:约 5 分钟。

- 触控 [☉]。
- 触控 [清洁] 选择程序。
- 显示屏将带领您完成整个程序。
- 清洁并重新插入饮料出口，清空并重新插入滴水盘。
- 打开粉剂抽屉，放入一片清洁片剂，然后关上粉剂抽屉。

- 关上门。
- 请将 0.5 升容量的容器放置在饮料出口的下方。
- 触控 [▷] 确定。清洁程序将运行大约 5 分钟。
- 取下容器、清空并重新插入滴水盘，然后关上门。
- 触控 [▷] 确定。清洁完成，机器可再使用。
- 触控 [☉] 退出程序。

## 钙化清洁

所需时间:约 26 分钟。

钙化清洁将原本独立的清洁和除垢功能结合在一起。若两个功能的运行时间皆很接近，本台全自动咖啡机会自动建议采用此保养程序。

- 触控 [☉]。
- 触控 [钙化清洁]，选择该程序。
- 显示屏将带领您完成整个程序。
- 清洁并重新插入饮料出口，清空并重新插入滴水盘。
- 打开粉剂抽屉，放入一片清洁片剂，然后关上粉剂抽屉。
- 必要时，请取出过滤器，然后触控 [▷] 确定。
- 在空水箱中加入微温水至“0.5 升”的标记处，然后将两片除垢片剂00311556溶解在水中。

**i** 若水箱中的除垢溶液太少，将显示相应的要求。请倒入无碳酸的水，然后再次触控 [▷] 确定。

- 从牛奶盒中取下并擦拭牛奶软管，并将牛奶软管的一端插入咖啡渣盒孔。
  - 关上门。
  - 请将 0.5 升容量的容器放置在饮料出口的下方。
  - 触控 [▷] 确定。
- 该程序将运行约 19 分钟。
- 请移开容器，然后触控 [▷] 确定。
  - 清洗水箱，(必要时)请重新插入过滤器。
  - 在水箱中加入干净的水至“max”(最高)标记处。
  - 重新插入水箱，然后关上门。
  - 将容器重新放置在饮料出口的下方。
  - 触控 [▷] 确定。

该程序将运行约 7 分钟，然后清洗机器。

- 取下容器、清空并重新插入滴水盘，然后关上门。



- 触按 [ D ] 确定。除垢程序完成, 机器可再次使用。
- 触按 [ .☉ ] 退出程序。

## 特殊清洗

**i** **重要:** 若其中之一保养程序中断, 例如电源故障, 请按显示屏的信息继续以下的步骤:

- 清洗水箱, 然后在水箱中加入干净的水至“max”(最高)标记处。
- 触按 [ D ] 确定。该程序将运行约 2 分钟, 然后清洗机器。
- 清空并重新插入滴水盘, 然后关上门。机器可再次使用。
- 触按 [ .☉ ] 退出程序。

## 节能秘诀

- 触按 [ Ⓞ ], 机器将进入“节能模式”。机器在节能模式状态下耗电量非常低, 但仍继续监控所有与安全相关的功能, 以防止损坏。
- 在菜单的“自动待机时间”设置 15 分钟后自动关闭。
- 可在菜单中设置减少显示屏亮度和照明, 这样可以更省电。
- 请尽量不去中断正在冲泡的咖啡或奶沫。提前终止进行中的程序, 需耗费更多的电能, 滴水盘也会满得较快。
- 请定期执行机器的除垢程序, 以免水垢累积。水垢会消耗更多电能。

## 防冻保护

为了避免在运输和存放的过程中受到霜冻的伤害, 在之前应完全清空机器(参见“菜单- 防冻功能”章节)。

## 存放附件

本台全自动咖啡机内配有用于存储附件和快速指南的专用附件收放处。

- 咖啡勺和过滤器皆放置在附件收放处上。
- 快速指南收在附件收放处前面的特殊夹缝中。
- 长型导奶管则存放在机门内侧的搁架上。
- 连接件在粉剂抽屉上方的磁架上固定。

## 附件

以下附件可经由经销商及客户服务订购:

附件	订购号 客户服务
清洁片剂	00311808
除垢片剂	00576694
过滤器	00575491
保养组	00576331
带有“freshLock”盖子的牛奶盒。	00576165
用于 92° 开启角度的限制件	00636455

## 废弃物处理



对本设备根据有关电气和电子设备报废的欧洲规定 2012/19/EU (waste electrical and electronic equipment - WEEE) 进行标记。该规定管理在欧洲范围内对报废设备的回收和再生。

## 保修

该设备的保修条款将由售国期的销售代表来确定。您可向售出此设备的经销商详细了解这些条款。

当根据保修条款进行任何索赔时, 必须出具销售凭证或收据。

如有更改, 恕不另行通知。

## 简单故障排除

故障	原因	解决办法
咖啡和奶沫质量差异太大(例如份量有差异或奶沫溢出)。	机器结垢。	机器请按说明书进行除垢,参见“保养程序”章节。
	导奶管被堵塞。	请清洁导奶管。
无法冲泡饮料。	饮料出口或三个接口其中之一被堵塞。	请清洁导奶管和接口。
饮料在冲泡时从出口整个涌出。	饮料出口下部件故障。	安装下部件,参见“清洁加奶系统”章节。
奶沫不足或没有奶沫或是导奶管无法引入牛奶。	机器结垢。	机器请按说明书进行除垢,参见“保养程序”章节。
	饮料出口或三个接口其中之一被堵塞。	请清洁导奶管和接口。
	牛奶不适合打泡。	请勿使用已煮过的牛奶。使用脂肪含量至少为 1.5% 的冰牛奶。
	饮料出口或导奶管安装不当。	将部件浸湿并重新安装。
	导奶管被堵塞。	请清洁导奶管。
	未达到个人设置的份量,咖啡流速成滴状或完全停流	研磨度设置得太细。咖啡粉太细。
	机器结垢严重。	机器请按照说明书进行除垢,参见“保养程序”章节。
	酿造单元变脏。	请清洁酿造单元,参见“清洁酿造单元”章节。
热水尝起来有牛奶或咖啡的味道。	导奶管尚未取下。	将导奶管从牛奶盒上取下。
	饮料出口有牛奶或咖啡的残渣。	清洗饮料出口。
煮出的咖啡无咖啡“油脂”。	使用不适当的咖啡种类。	改用罗布斯塔含量较高的咖啡豆。
	咖啡豆不新鲜。	使用新鲜的咖啡豆。
	研磨度与咖啡豆不相配。	研磨度设置得太细。
咖啡太“酸”。	研磨度设置得太粗。咖啡粉太粗。	研磨度设置得太细。使用较细的咖啡粉。
	使用不适当的咖啡种类。	请更换咖啡的种类。
咖啡太“苦”。	研磨度设置得太细。咖啡粉太细。	研磨度设置得太粗。使用较粗的咖啡粉。
	使用不适当的咖啡种类。	请更换咖啡的种类。
咖啡尝起来有“焦味”。	酿造温度太高。	降低温度,参见“调整饮料”章节。
	研磨度设置得太细。咖啡粉太细。	设置较粗的研磨度。使用较粗的咖啡粉。
	使用不适当的咖啡种类。	请更换咖啡的种类。

故障	原因	解决办法
咖啡太淡。	选择的咖啡浓度太低。	提高咖啡浓度, 参见“调整饮料”章节。
	咖啡粉在粉剂抽屉内堵塞。	取出粉剂抽屉, 清洗并彻底晾干。
咖啡粉仍留在粉剂抽屉内。	咖啡粉黏在一起。	请勿在粉剂抽屉内将咖啡粉往下压。
	粉剂抽屉有湿气。	取出粉剂抽屉, 清洗并彻底晾干。
水箱中的过滤器未固定到位。	过滤器安装不正确。	将过滤器垂直向下用力压入水箱接口。
咖啡豆箱在插入时卡住。	咖啡豆在外壳中。	移除咖啡豆。
咖啡渣未压实和过湿。	研磨度设置得过细或过粗。使用的咖啡粉太少。	将研磨度调至更粗或更细, 或使用两平匙的咖啡粉。
研磨调整装置运行不平滑。	研磨器里太多咖啡豆。	冲泡一杯来自咖啡豆的饮料。更改研磨度, 仅限较小幅度的调整。
酿造装置不能插入。	酿造装置的位置不正确。	请按说明书将酿造装置插入, 参见“清洁酿造单元”章节。
	酿造装置已锁定。	将酿造装置锁定, 参见“清洁酿造单元”章节。
酿造装置的防护盖无法正确安装。	酿造装置无法锁定。	将酿造装置锁定, 参见“清洁酿造单元”章节。
滴水盘底部有水,	有可能是冷凝水。	请勿插入没有装上盘盖的滴水盘。
显示屏显示 “12:00”	电源故障或机器用电源开关关闭。	重新输入新数值, 不要使用电源开关关闭机器或将菜单中的时钟显示调至“关”。
显示屏显示 “是否已连接牛奶盒?” 虽然牛奶盒已连接。	牛奶盒不在传感器的侦测范围内。	请将牛奶盒放置在机器的右缘。
	未侦测到物料, 例如牛奶盒。	触按“是”确定显示屏的询问或使用随附的牛奶盒。
显示屏显示 “电压过高或过低!”	过高或过低的电压。	请与电力供应商或电力运营商联系。由受过训练的专业人员检查电源电压。
显示屏显示 “请让电器冷却”	电器过热。	关闭电源 30 分钟。
显示屏显示, 例如: “故障: E0510”	机器发生故障。	请根据显示屏进行操作。
显示屏显示 “为豆箱补充咖啡豆”, 虽然咖啡豆已装满或研磨器没有研磨咖啡豆的动作。	咖啡豆没有掉入研磨器内(咖啡豆过油)。	轻轻拍打咖啡豆盒。必要时, 请更换咖啡豆种类。用干布将空咖啡豆箱擦干净。

故障	原因	解决办法
显示屏显示 “清洁冲酿造单元”	酿造单元不干净。	请清洁酿造单元。
	酿造单元内的咖啡粉过多。	请清洁酿造单元。最多倒入两平匙的咖啡粉。
	酿造单元的机件运行不平滑。	请清洗酿造单元,参见“维护和日常清洁”章节。
显示屏显示 “重新加满不含碳酸的水或拆下过滤器”	水箱插入错误	请正确插入水箱
	水箱内有含碳酸的水。	请将新鲜的自来水倒入水箱内。
	浮标在水箱被卡住。	请取下水箱,然后彻底清洁。
	新的过滤器若不遵循说明书清洗,可能导致过滤器的耗损。	请根据说明书清洗过滤器,然后再使用或使用新的过滤器。
	过滤器有气泡。	请将过滤器浸泡在水中一段时间,直到无气泡逸出,再将过滤器重新插入。
尽管已清空滴水盘,显示屏仍显示 “清空滴水盘”。	滴水盘又脏又湿。	请将滴水盘彻底清洁并晾干。
	关机时,未侦测到已清空。	开机时,请将滴水盘取出并重新插入。
尽管已插好滴水盘,但显示屏上显示 “插入滴水盘”。	机器内部(滴水盘)不干净。	请清洁机器内部。
	咖啡渣盒未完全插入卡紧。	请将咖啡渣盒插入卡紧。
除去滴水盘后,水滴在机器内的底部。	滴水盘太早取下。	最后一次冲泡饮料后,请等待数秒,再将滴水盘取下。
显示屏上显示 “请打开门,使用电源开关关机,并在30秒后再开机!”	机器过热。	让机器冷却。
	酿造单元不干净。	请清洁酿造单元。
Home Connect 没有正常工作。		转至 <a href="http://www.home-connect.cn">www.home-connect.cn</a>

**若有任何问题,请务必拨打热线电话!全国统一客户服务热线详见说明书第7页。**

## 技术数据

电气连接(电压 - 频率)	220-240 伏 ~ - 50/60 赫兹
电力负载	1600 瓦
最大泵压(静态)	19 巴
咖啡豆箱的最大容量(无过滤器)	2.4 升
咖啡豆箱的最大容量	500 公克
电源线的长度	1.7 米
尺寸(高 x 宽 x 深)	455 x 495 x 375 毫米
重量,空机	19-20 公斤
研磨器的种类	陶瓷

---

## Contents

Included in delivery (for use) .....	29
Congratulations .....	30
Intended use.....	31
Important safety information .....	31
Overview.....	33
Controls .....	33
Initial use .....	34
Control panel .....	36
Preparing drinks .....	36
Preparation using coffee beans.....	39
Preparation using milk.....	39
Preparation using ground coffee .....	40
Dispensing hot water .....	40
Personalised drinks .....	41
Adjusting the grind setting .....	42
Child-proof lock.....	42
Menu.....	42
Home Connect.....	44
Care and daily cleaning.....	47
Service programmes .....	50
Tips on energy saving .....	52
Frost protection.....	53
Storing accessories .....	53
Accessories .....	53
Disposal.....	53
Guarantee.....	53
Simple troubleshooting .....	54
Technical specifications .....	57

---

## Included in delivery (for use)

(Figure A on the fold-out pages)

- a** Fully automatic coffee machine
- b** Instruction manual
- c** Quick reference guide
- d** Measuring spoon
- e** Water hardness testing strip
- f** Milk tube (set)
- g** Milk container
- h** Suction pipe

---

## Congratulations ...

... on purchasing this fully automatic coffee machine! You have now acquired a high-quality and modern kitchen appliance. It combines innovative technology with a range of functions and is easy to use. It will enable you to prepare a variety of delicious hot drinks quickly and simply – whether you're in the mood for an invigorating espresso, a creamy cappuccino, a smooth latte macchiato or white coffee, or a traditional cup of coffee. At the same time the appliance offers you a wide range of options for adapting it to your individual taste.

To ensure that you can use this fully automatic coffee machine with all its functions and features reliably and safely, we would like you to familiarize yourself with its components, functions, displays and controls. These instructions are designed to help you. So please take the time to read them before you switch on the appliance.

### **Technical specifications:**

Voltage: 220V-240V~

Frequency: 50-60Hz

Power rating: 1600W

### **Country of origin:**

Slovenia

### **Exclusive distributor:**

BSH Home Appliances (China) Co., Ltd.

Zhongnan International Tower Building 20 and 21, No. 129 Zhongshan Road, Nanjing

### **Applicable Standards:**

GB 4706.1-2005

Safety of Household and Similar Electrical Appliances Part 1: General Requirements

GB 4706.19-2008

Safety of Household and Similar Electrical Appliances – Particular Requirements for Liquid Heaters

GB 4706.30-2008

Safety of Household and Similar Electrical Appliances – Particular Requirements for Kitchen Machines

## **How to use these instructions**

You can open up the front cover of this instruction manual. There you will find illustrations of the appliance with each part numbered. These numbers will be referred to throughout the text.

Example: brewing unit (15)

These instructions also show display texts and symbols in a special way. These enable you to clearly see where we refer to texts or symbols that are marked or displayed on the appliance.

Display indicators:

“Espresso”

Buttons and controls on the display:

[ ▷ ]

The appliance comes with a quick reference guide where you can find the most important functions at a glance. It can be stored in the accessory drawer of the appliance.

Careline: 4008855888

Service E-mail: [careline.china@bshg.com](mailto:careline.china@bshg.com)

---

## **Intended use**

This appliance is intended for domestic use only.

Only use the appliance indoors at room temperature and up to 2000 m above sea level.

---

## **Important safety information**

Please read and follow the operating instructions carefully and keep them for later reference! Enclose these instructions when you give this appliance to someone else.

This appliance can be used by children aged from 8 years and above and by persons with reduced physical, sensory or mental capabilities or lack of experience and knowledge if they have been given supervision or instruction concerning use of the appliance in a safe way and if they understand the hazards involved. Keep children under 8 years of age away from the appliance and connecting cable and do not allow them to use the appliance. Children shall not play with the appliance. Cleaning and user maintenance shall not be made by children unless they are older than 8 years and supervised.

**⚠ Warning**

**Risk of electric shock!**

- The appliance may only be connected to a power supply with alternating current via a correctly installed socket with earthing. Ensure that the protective conductor system of the domestic supply has been correctly installed.
- Connect and operate the appliance only in accordance with the specifications on the rating plate.
- Do not use the appliance if the power cord and/or appliance are damaged.
- Only our customer service may repair the appliance, e.g. by replacing a damaged power cord, in order to avoid hazards.
- Never immerse the appliance or mains cord in water.
- If there is a fault, pull out the mains plug immediately or switch off the power supply.

**⚠ Warning**

**Hazard due to magnetism!**

The appliance contains permanent magnets which can affect electronic implants such as pacemakers or insulin pumps. Persons wearing electronic implants must maintain a minimum distance of 10 cm from the appliance and from the following parts upon removal: milk container, milk system, water tank and brewing unit.

**⚠ Warning**

**Risk of suffocation!**

- Do not allow children to play with packaging material.
- Store small parts safely as they can be easily swallowed.

**⚠ Warning**

**Risk of injury!**

- Do not reach into the grinding unit!
- Be careful not to jam your fingers when closing the door.
- Improper use of this appliance may result in injury.

**⚠ Warning**

**Risk of burns!**

- The beverage outlet gets very hot. After use, always let it cool down before you touch it.

**⚠ Warning**

**Risk of scalding (Home Connect)!**

If an unattended remote start takes place, third parties might be scalded if they reach under the coffee dispenser during drinks dispensing. You should therefore make sure that with an unattended remote start that there is no risk to other people, in particular not to children, or to property.



## Overview

(Figures **B** to **E** on the fold-out pages)

- 1 Appliance door**
  - a Recessed grip (for opening the door)
  - b Drip plate
- 2 Control panel (see next page)**
  - a Control ring
  - b Information display
  - c Touch display (left and right)
- 3 Outlet system (coffee, milk, hot water), height-adjustable**
  - a Cover
- 4 Milk system**
  - a Snap lever
  - b Beverage outlet (upper part, lower part)
  - c Milk tube (2 pieces)
  - d Connecting element, metal (for magnet holder)
- 5 Mains switch [ O/I ] (power supply)**
- 6 Accessory drawer (for quick reference guide and accessories)**
  - a Quick reference guide
  - b Measuring spoon
  - c Water hardness strip
  - d Milk tube (set)
- 7 Removable water tank**
  - a Lid for water tank
- 8 Removable bean container**
  - a Lid for bean container
- 9 Slide regulator for grinding degree setting**
- 10 Magnet holder (for connecting element)**
- 11 Removable drawer (for ground coffee/cleaning tablet)**
- 12 Holder (for milk tube)**
- 13 Protective cover (for brewing unit)**
- 14 Brewing unit**
  - a Locking mechanism
  - b Cover
- 15 Eject lever**
- 16 Removable Drip tray**
  - a Drip tray cover
  - b Coffee grounds container
- 17 Collecting tray**

## 18 Holder

- a Suction pipe

## 19 Rating plate (E number, FD)

## 20 Shelf with sensor (for milk container)

## 21 Milk container

- a Stainless steel container
- b Lower part of the lid
- c Upper part of the lid

**i** Further information about the appliance, such as how to change the opening angle of the door, can be found in the assembly instructions.

## Controls

The appliance features user-friendly menu navigation to ensure that operation is as easy as possible while at the same time offering a wide range of functions. That means a range of options can be selected with just a few operating steps.

### Mains switch [ O/I ]

The power switch [ O/I ] (with the door open) is used to switch the appliance on, or to switch it off fully (power supply off).

**i Important:** Do not press the mains switch while the appliance is in use. Switch off the appliance only when it is in energy saving mode, so that it can rinse automatically.

### Control panel (touch field)

**i Important:** These operating instructions refer to several models. In some models [ ⊕ ] and [ ▷ ] are touchscreen elements.

### [ ⊕ ] on/off

Press [ ⊕ ] to switch on the appliance or put it into energy saving mode. The appliance is rinsed automatically.

The appliance does not rinse if:

- if it is still warm when switched on, or
- if no coffee was dispensed before it was switched off.

The appliance is ready for use as soon as the symbols for the drinks selection appear on the display.

### [▷] start/stop

Press [▷] for either beverage preparation or to launch a service programme.

Press [▷] again while the drink is being prepared to prematurely halt dispensing.

There are four menu fields in the control panel which can be activated by touching. The active menu field lights up red.

[□]

[□] lights up as soon as the appliance is in operation. Drinks can be selected and dispensed or settings for the drinks can be changed.

### [☒] MyCoffee

Touch [☒] to open the selection of “Personalised beverage preparation”. Personal settings for coffee drinks can be saved and called up (see the section “Personalised drinks”).

### [☞] Menu

Touch [☞] to call up the menu. Settings can be made, information called up or the appliance connected with “Home Connect” (see section “Menu”).

### [☉] Service

Touch [☉] to open the selection of service programmes. Run the desired programme as described in the section “Service programmes”.



Press [☞], [☉] or [☒] again to exit the respective menu.

### Control ring

Turn the control ring to navigate in the display or to change parameters.

### Information display

The round display shows the drink selected, the settings or information.

### Touch display (left and right)

Depending on the setting, different fields are shown in both the touch displays. A field is activated when touched either to enter settings or change values.

## Initial use

### General

Fill the appropriate container using only pure, **cold**, uncarbonated water and solely **roasted** beans. Do not use coffee beans that have been glazed, caramelised or treated with other additives containing sugar, since they will block the brewing unit.



Before the appliance can be switched on and used, it must be assembled and connected according to the enclosed assembly instructions.

### Setting up the appliance

- Remove any protective plastic film.



**Important:** Only use the appliance in a frost-free room. If it has been transported or stored at temperatures below 0°C, wait at least 3 hours before initial use.

- Take hold of the appliance door by the recessed grip and open.
- Remove the water tank, rinse it and fill it with fresh water up to the “max.” mark.
- Replace the water tank and click into place.
- Remove the bean container, fill with coffee beans and replace.
- Set the mains switch to [Ⓢ] and close the appliance door.

The appliance heats up and is rinsed.

The control panel is activated.

“Language” appears.

- Turn the control ring with your finger to select the desired language and touch the [Water hardness] field.



It is important to set the water hardness correctly to enable the appliance to accurately indicate when the descaling programme should be run. The preset water hardness is level 4. If a water softener is installed in the house, please set the water hardness to level 3. You can also check the water hardness by asking your local water supplier.

- Use the enclosed test strip to determine the water hardness. Briefly dip the test strip in water and check the result after one minute.

Level	Water hardness	
	German (°dH)	French (°fH)
1	1-7	1-13
2	8-14	14-25
3	15-21	26-38
4	22-30	39-54

- Turn the control ring with your finger to set the water hardness determined.
- [Home Connect] appears on the left and on the right [Set-up complete].
- To now connect the appliance to the WLAN network (home network), touch [Home Connect].
- To connect the appliance to the WLAN network later on, touch [Set-up complete]. The settings for Language and Water hardness are saved.



When selecting [Home Connect] please read the detailed description in the section “Home Connect”.

The appliance is ready to use as soon as the drink symbols are shown and the [☐] lights up.

The integrated fan switches on each time a drink is dispensed and switches off again after a few minutes.

When the appliance is used for the first time after running a service program, or if it has not been operated for a long period, the first beverage will not have the full aroma and should not be consumed.

When the fully automatic coffee machine is first used, a suitably thick and stable “crema” is only achieved after the first few cups have been dispensed.

## Switch off appliance

- Press [⓪].

The appliance rinses and switches to energy saving mode.

**Exception:** If only hot water is dispensed, the appliance switches off without rinsing.

- To switch the appliance off completely, open the appliance door and set the mains switch to [⓪].



**Important:** Do not press the mains switch while the appliance is in use. Switch off the appliance only when it is in energy saving mode, so it can rinse automatically.

The factory settings of the fully automatic coffee machine are programmed for optimal performance. The appliances switch automatically to the energy saving mode after a configured time and rinses (duration can be set, see “Switch off after” in the section “Menu”).

The appliance is equipped with a sensor. If there is a milk container, this will be correspondingly shown on the display when switching to the energy saving mode. If there is milk in the container, please keep in the fridge.

## Control panel

Information is shown on the display or settings can be entered by touching the touchscreen and the control ring.

### Display

The control panel shows the selected drinks, settings and setting options, as well as messages about the appliance's operating status.

e.g. Drink selection





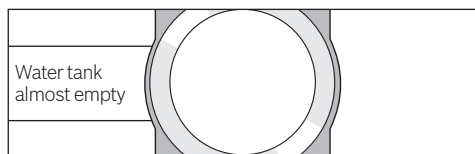



e.g. Information



Information disappears after operating the appliance or after a short time.

The information remains however in the information display in the form of a small symbol.

-  Bean container almost empty
-  Water tank almost empty
-  Replace water filter
-  Cleaning programme necessary
-  Descaling programme necessary
-  Calc'nClean programme necessary

### Prompts to take action

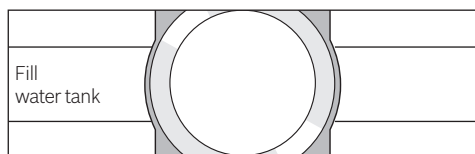

**i** If the action required was carried out, e.g. filling the water tank, the corresponding message and symbol will disappear.

### Operation

Touch texts or symbols combined with turning the control ring to navigate in the control panel (for an example, see section "Drink adjustment").

An audible signal is heard when touching the touch display. These audible signals can be switched on or off (see the section "Menu – Key tones").

## Preparing drinks

This fully automatic coffee machine can be operated using coffee beans or ground coffee (but not instant coffee).

If using coffee beans, they will be freshly ground for each brewing. For optimum quality, store the beans in a cool place in sealed containers.

**i** **Important:** Fill the water tank with fresh, uncarbonated, cold water every day. The tank should always contain sufficient water for operating the appliance.

**Tip:** Cups should be prewarmed, e.g. with hot water. This applies particularly to small thick-walled espresso cups.

For some settings, coffee is prepared in two stages (see the section "Aroma Double Shot" and "Two cups at once"). Please wait until the process is completely finished.

### Beverage selection

Turn the control ring to select different drinks: The symbol and the name of the selected drink will appear in the middle of the information display.

The values currently set, e.g. for the coffee strength and temperature are shown on the left and right of the touch display.



**The following drinks can be selected:**

- Ristretto
- Espresso
- Espresso Macchiato
- Coffee
- Cappuccino
- Latte Macchiato
- Caffe Latte
- Milk froth
- Warm milk
- Hot water

The drink selected can be directly prepared with the pre-set values or first adjusted to individual taste.

**Drink adjustment**

Touch one of the fields shown on the touch display, e.g. [∅] to activate the field, [∅] turns red.

Turn the control ring to change the setting. Touch [∅] again to save the setting.

**An example:**

The values for a cup of Coffee can be changed as follows:

- Turn the control ring and select “Coffee”.

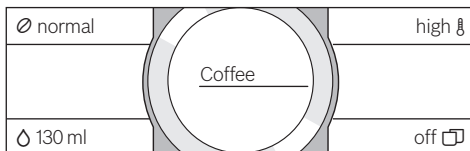

- Touch the field, e.g. [∅] to active, [∅] lights up red.

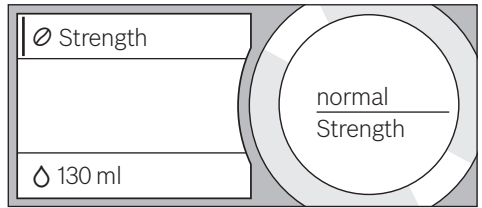

- Turn the control ring and set the desired coffee strength in the middle of the information display , e.g. to “very strong”.

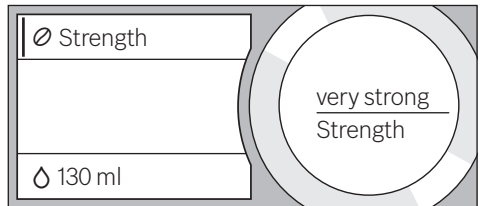

- Touch the field [∅].
- Turn the control ring to set the required amount of coffee, e.g. “160 ml”.

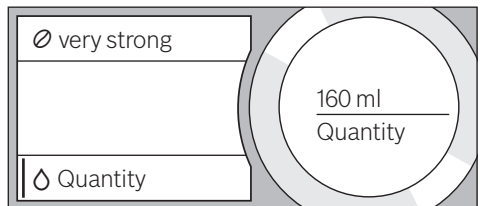

- Touch the field [∅].
- Turn the control ring and set the desired temperature, e.g. “very high”.

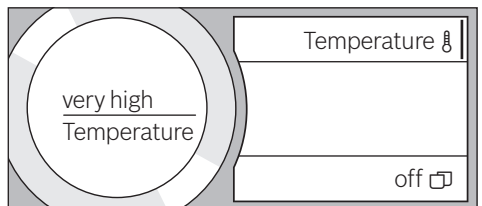

- Save the settings by touching the active field or by starting to dispense the drink.

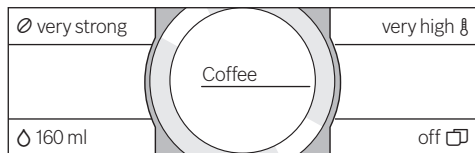

- i** There are different setting options depending on the type of drink. For coffee drinks, for example, the strength, temperature and quantity can be set, for milk only the volume.

**The following settings are possible:**

**Coffee strength**

- very mild
- mild
- normal
- strong
- very strong
- Double Shot strong
- Double Shot strong +
- Double Shot strong ++

- i** **Aroma Double Shot**  
The longer the coffee is brewed, the more bitter substances and undesired aromas are released. This has a negative effect on the taste and makes the coffee less easily digestible. For extra strong coffee, the appliance has therefore a special Aroma Double Shot function. When half the quantity has been prepared, it grinds and brews fresh coffee beans so that only the pleasant, aromatic scents are released.

The Aroma Double Shot function is not available for ristretto, espresso macchiato, and when ground coffee is used.

**Volume**

The volume differs depending on the type of drink and can be set in ml steps.

- i** The volume dispensed can fluctuate depending on the quality of the milk.

**Drink temperature**

Values for coffee drinks:

- normal
- high
- very high

Values for hot water:

- 70°C White tea
- 80°C Green tea
- 90°C Black tea
- Max Fruit tea

- i** If no controls are activated for approx. 30 seconds, the appliance will automatically exit the settings mode. The settings made will be automatically stored.

**Two cups at once**

Touch [ ] to prepare two cups of the selected drink simultaneously. The setting is shown as text, e.g. “2x Espresso”.

- Touch [ ].

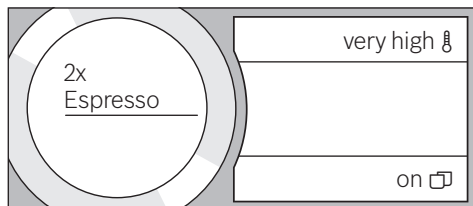

- Place two cups left and right underneath the beverage outlet.
- Press [ ] to start dispensing. The selected drink is prepared and then dispensed into both cups.

- i** The drink is prepared in two stages (two grinding operations). Please wait until the process is completely finished.

Two cups at once cannot be dispensed for the settings “Aroma Double Shot” or “ground coffee”.

## Preparation using coffee beans

The appliance must be ready for use.

- Place a cup underneath the beverage outlet.
- Turn the control ring and select “Ristretto”, “Espresso” or “Coffee”.

The display shows the selected drink along with the preset values for the drink.

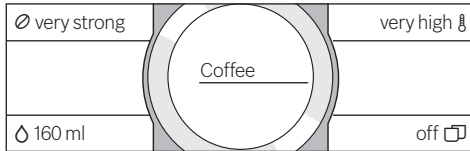

**i** The settings can be changed as described in the section “Drink adjustment”.

- Press [ ▷ ] to start dispensing. The coffee is brewed and then dispensed into the cup. Press [ ▷ ] again to prematurely halt dispensing.

## Preparation using milk

This fully automatic coffee machine has an integrated beverage outlet. This can be used to prepare coffee drinks with milk or also milk froth and warm milk.

**⚠ Risk of burns!**  
The beverage outlet gets very hot. After use, always let it cool down before you touch it.

### Milk container

The milk container has been designed especially for use together with this fully automatic coffee machine. It is intended solely for use in the household and for storing milk in the refrigerator. The insulated container keeps milk cool for a number of hours.

**i** **Important:** Remove cups or glasses before opening the door in case they fall.

Connecting the milk container or a milk carton:

- Open the appliance door.
- Remove the cover of the beverage outlet towards the front.
- Connect and fix the milk tubes and connecting elements as illustrated.

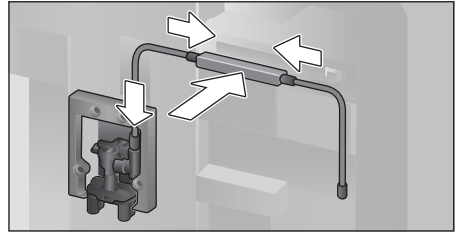

- Attach the cover firmly from the front on to the beverage outlet.
- Attach the suction pipe and insert into the milk container or a milk carton.

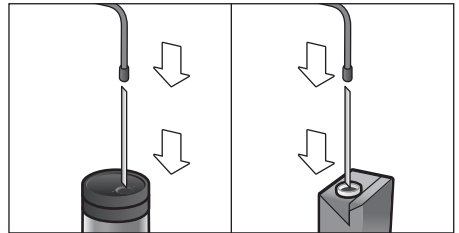

- Close the appliance door.

**i** Dried milk residues are difficult to remove, therefore **always** clean (see the section “Cleaning the milk system”).

## Coffee drinks with milk

- Place a cup or glass underneath the beverage outlet.
  - Turn the control ring and select “Espresso Macchiato”, “Cappuccino”, “Latte Macchiato” or “Caffe Latte”.
- The display shows the selected drink along with the preset values for this drink.

**i** The settings can be changed as described in the section “Drink adjustment”.

- Press [ ▷ ] to start dispensing.

## en Preparation using ground coffee

The milk is dispensed into the cup or glass first. Then the coffee is brewed and runs into the cup or glass.

Press [ ▷ ] again to stop the current step of the process prematurely.

### Milk froth or warm milk

- Place a cup or glass underneath the beverage outlet.
- Turn the control ring and select “Milk froth” or “Warm milk”.

 The settings can be changed as described in the section “Drink adjustment”.

- Press [ ▷ ] to start dispensing. Milk froth or warm milk is dispensed from the beverage outlet.
- Press [ ▷ ] again to prematurely halt the dispensing process.

---

## Preparation using ground coffee

 When using ground coffee, the setting for the strength of the coffee and dispensing two cups at once is not available.

**Important:** Remove cups or glasses before opening the door in case they fall.

The appliance must be ready for use.

- Open the appliance door.
- Remove the ground coffee drawer. The removable drawer must be dry.
- Put in coffee powder (maximum 2 level measuring spoons); do not press firmly.

 **Caution!** Do not use whole beans or instant coffee.

- Replace the ground coffee drawer.
- Close the appliance door.

 If coffee is not dispensed within 90 seconds, the brewing chamber empties automatically to avoid an overflow. The appliance is then rinsed.

- Place a cup underneath the beverage outlet.
- Turn the control ring and select a coffee drink or a coffee drink with milk.

The display shows the selected drink, a measuring spoon and the preset values for this drink.

 The settings can be changed as described in the section “Drink adjustment”.

For coffee drinks with milk, please observe the instructions in the section “Preparation using milk”.

- Press [ ▷ ] to start dispensing. The coffee is brewed and then dispensed into the cup. When selecting coffee drinks with milk, the milk is first dispensed and then the coffee brewed.

 For another drink with ground coffee, repeat the procedure.

---

## Dispensing hot water



### Risk of burns!

The beverage outlet gets very hot. After use, always let it cool down before you touch it.

The appliance must be ready for use.

- Remove the milk tube from the milk container.
- Remove any milk or coffee residue from the outlet.
- Place a cup or glass underneath the beverage outlet.
- Turn the control ring and select “Hot water”.

 The settings can be changed as described in the section “Drink adjustment”.



- Press [ ▷ ] to start dispensing.
- The message appears “Milk hose separated from milk container?”.
- If still connected, remove the milk tube and touch [Yes] on the display. Hot water flows out of the beverage outlet. Press [ ▷ ] again to prematurely halt the dispensing process.



## Personalised drinks

Touch [  ] to open the selection for personalised drinks.

Up to 8 storage spaces can be used. Save your favourite drinks that are frequently dispensed here with all their settings.

 Touch [  ] to exit the menu without saving at any time.

### Entering or changing drinks

- Touch [  ]. The selection of memory locations appears.
- Turn the control ring to choose an empty memory location (empty glass) to make a new entry, change an occupied memory location, or delete a favourite drink.
- Select [new] at an empty memory location or [Details] at an occupied memory location.

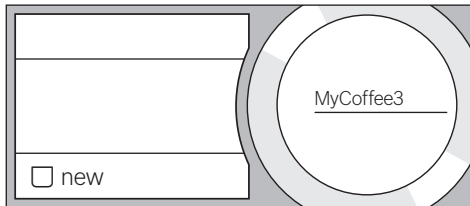

The menu for adjusting the drinks opens. The last drink dispensed is shown with the last settings selected.

- If you do not wish to save last drink dispensed, turn the control ring and select another drink.
- Touch each setting to be changed and turn the control ring to adjust the values as desired.

Other setting options appear depending on the selection.

- Touch [Further details | Save] to enter other settings.

 For milk drinks, the mixing ratio of coffee and milk can be set.

- The settings can be stored under an individual name. Touch [Name]. The mask for entering the name opens.

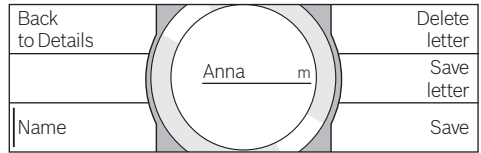

- Turn the control ring and select a letter or a symbol.
- Touch [Save letter] to confirm the letter selected or [Delete letter] to delete it.
- Select other letters or symbols and confirm.
- With [Save] the entry is adopted. The selection menu opens.
- Touch [  ] to exit the menu.

### Deleting a drink

- Touch [  ]
- Turn the control ring and select the occupied memory location.
- Touch [Details] and [Further details | Save].
- Touch [Delete beverage] and then [Delete].

The memory location is again free.

### Select a personalised drink and dispense

Touch [  ]. The selection of memory locations opens.

- Turn the control ring and select the desired memory location.
- Place a cup or glass underneath the beverage outlet.
- Press [  ] to start dispensing.

## Adjusting the grind setting

This fully automatic coffee machine has an adjustable grinding unit. This enables the grinding level of the coffee to be individually changed.

- Open the appliance door.
- Slide the regulator to select the grinding degree setting between finely ground coffee ☼ and coarsely ground coffee ☼.

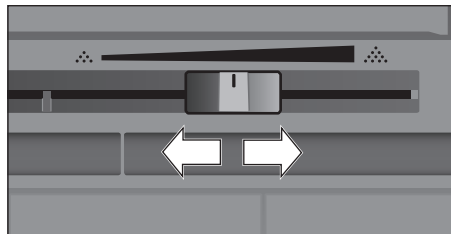

- Close the appliance door again.

**i** For dark roast coffee beans, choose a finer grind, for lighter beans a coarser grind.

**Tip:** Only make small changes to the grinding degree setting.

The new setting will not become apparent until after the second cup of coffee.

If the display shows the message “Select a coarser degree of grinding”, this means that the beans are being ground too finely. Adjust the grinding level to a coarser setting.

## Child-proof lock

The appliance can be locked to protect children against scalding and burns.

- Press and hold [☞] for at least 4 seconds. “Child-proof lock activated” briefly appears on the display. No further operation is now possible; only [☞] can be pressed.
- To deactivate the child lock, press and hold [☞] for at least 4 seconds. “Child-proof lock deactivated” briefly appears on the display.

## Menu

The menu is used for changing individual settings, accessing information and launching processes.

- Touch [☞] to open the menu. The different setting options will appear in the touch display and the current setting in the round information display.

### Navigating through the menu:

By touching e.g. language the corresponding setting option is activated and highlighted red.

Turn the control ring to enter the settings, e.g. “English”. By touching [Next], other setting options will appear.

Language	English	Illumination
Water hardness		Brightness illumination
Switch off after		Next>

### For example:

Set the appliance at 15 minutes to switch off automatically:

- Touch [☞]. The menu opens.
- Touch [Switch off after], the field is highlighted red.
- Turn the control ring and select “00h15m”.
- Touch [☞]. [Save] and [Do not save] appears.
- Touch [Save]. The setting is saved. The drink selection appears on the display.

**i** Press [☞] to exit the menu at any time. If no entry is made within approx. 30 seconds, the menu closes automatically and the settings are not saved.

### The following settings can be made:

Language

Set the desired language to show the display texts.

Water hardness

Set this to the local water hardness. Level “1 (soft)” to “4 (very hard)” can be selected. The preset water hardness is “4 (very hard)”.

- i** It is important to set the water hardness correctly to enable the appliance to accurately indicate when the descaling programme should be run.

You can check the water hardness using the enclosed test strip or by asking your local water supplier. If a water softening system is installed in the house, please select the “Softening device” setting.

#### Water filter

If a water filter is inserted, renewed or removed, the setting “insert”, “replace” or “remove” must be made in the menu.

- i** A water filter lessens limescale deposits, reduces impurities in water and improves the coffee taste. Water filters are available from retail outlets or from customer services (see the section “Accessories”).

#### Inserting or renewing a water filter:

A new water filter must be rinsed before it can be used.

- Turn the control ring to select either “insert” or “replace”.
- Press the water filter firmly into the opening of the water tank.

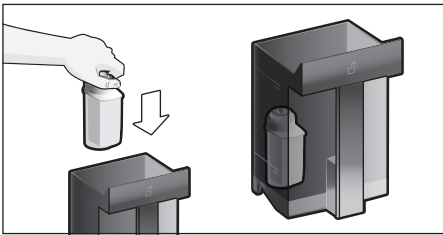

- Fill the water tank with water up to the “max” mark.
- Remove the milk tube from the milk container and close the door.

- i** **Caution:** Do not jam the tube when closing the door.

- Place a container with a capacity of 0.5 litre under the outlet .
- Press [ > ].

Water will now flow through the filter to rinse it.

- Then empty the container.

The appliance is ready for use again.

- i** Rinsing the filter simultaneously activates the setting for the change filter display.

The filter is no longer effective when the “Replace water filter – Press [ > ]” display appears, or at the latest after two months. It needs to be replaced for reasons of hygiene and to prevent a build-up of limescale (which could damage the appliance).

- If a new filter is not inserted, select the setting [ remove ] and press [ > ]. The message “Remove filter, reinsert water tank, close door” appears.

- i** If the appliance has not been used for a prolonged period (for example, while you are on holiday), the existing filter should be rinsed before the first time the appliance is used again. To do this, simply dispense a cup of hot water.

Detailed information about the water filter can be found in the manual supplied with the filter.

#### Home Connect

Settings for connection to WLAN network (home network) and mobile devices (see section “Home Connect”).

#### Switch off after

To set how long the appliance should wait after the last drink was prepared before it automatically rinses and switches itself off. You can specify values from 15 minutes to 8 hours. The factory setting is 30 minutes.

#### Illumination

Setting the illumination of the beverage outlet. “on”, “when in use” or “off” can be selected.

#### Brightness illumination

Setting the illumination lightness of the beverage outlet. “Level 1” to “Level 10” can be selected.

#### Brightness display

Setting the illumination lightness of display.

#### Key tones

Switch the signal tones on or off.

Clock displ.

Display option for time Off or Digital (on). The setting for this can be changed in the Clock menu option.

 If the appliance is switched off at the mains or there is a power failure, the settings for the time will be lost.

Clock

Setting for the current time.

Frost protection

Service programme to prevent frost damage during transportation and storage.

This programme completely empties the appliance.

- Empty the water tank and reinsert.
- If available remove the milk container and close the door.

The appliance automatically empties all its pipes.

- Empty the drip tray and re-insert.

Beverage info

Display shows how many drinks have been prepared since its initial use.

Factory settings

Resets your own settings to the condition when delivered.

- Touch [Reset] or [Do not reset] to either confirm or interrupt.

---

## Home Connect

This fully automatic coffee machine is Wi-Fi-capable and can be remotely controlled using a mobile device (e.g. tablet PC, smartphone). The Home Connect App offers additional functions which are a perfect complement to the networked appliance.

If the appliance is not connected to the WLAN network (home network), it functions in the same way as a fully automatic coffee machine with no network connection and can be operated as usual via the display.

 Please ensure that you follow the safety instructions given at the beginning of this instruction manual and that these are also observed when operating the appliance via the Home Connect app and when away from home. Please also follow the instructions in the Home Connect App.

 Operation on the appliance itself always takes priority, and during this time it is not possible to operate the appliance using the Home Connect App.

## Setting up

To implement settings via Home Connect, you must have installed the Home Connect App on a mobile device (e.g. tablet PC, smartphone). Please observe the supplied Home Connect documents with regard to this.

Follow the steps specified by the app to implement the settings.

Login of the appliance in the WLAN network can be carried out on initial set-up of the fully automatic coffee machine either directly or using the menu (first touch [

- Touch [Home Connect].
- Touch [Wi-Fi] to start the wireless connection. "Wi-Fi on" appears in the display.
- Touch [Connect network]. The following selection appears: [Connect automatically] and [Manually connect].

 If the router has WPS functionality, please select [Connect automatically].

## Connect automatically in the WLAN network (home network)

- Touch [Connect automatically]. The display shows [Automatic network connection].

- Press the WPS button on the home network router within a few minutes and wait until the display of the fully automatic coffee machine shows “Network connection successful”.
- Open the app on the mobile device.
- Touch [Connect with app]. The fully automatic coffee machine connects with the app.
- Wait until [Successfully connected with app] lights up briefly in the display.
- Touch [Remote start]. A warning message appears.
- Touch [Next] and read the warning message.
- Touch [confirm].

With the mobile device the functions of the fully automatic coffee machine can now be used to their full extent via the app.

-  If [Remote start] - [Deactivate] is selected, only the modes of the fully automatic coffee machine are displayed in the Home Connect app. You can specify settings but not start drinks dispensing.

## Connect manually in the WLAN network (home network)

- Touch [Manually connect]. The fully automatic coffee machine sets up a separate WLAN network which can be accessed with a tablet or smartphone. The display shows the SSID (the name) and the key (the password) of this network.
- Log the mobile device in to the network of the fully automatic coffee machine with the “HomeConnect” SSID and the “HomeConnect” key.
- Start the app on the mobile device and follow the instructions for network login in the app and the supplied Home Connect documents.

The login process is complete when “Network connection successful” lights up briefly in the display of the fully automatic coffee machine.

- Touch [Connect with app]. The app must also be opened on the mobile device. The fully automatic coffee machine connects with the app.
- Wait until [Successfully connected with app] lights up briefly in the display.
- Touch [Remote start]. A warning message appears.
- Touch [Next] and read the warning message.
- Touch [confirm].

With the mobile device the functions of the fully automatic coffee machine can now be used to their full extent via the app.

-  If [Remote start] - [Deactivate] is selected, only the modes of the fully automatic coffee machine are displayed in the Home Connect app. You can specify settings but not start drinks dispensing.

## Switching Wi-Fi on and off

Wi-Fi can be switched “On” or “Off” as required (e.g. when on holiday).

-  Network information is retained after the appliance is switched off.

After switching on, wait a few seconds until the fully automatic coffee machine has connected to the WLAN network again.

In networked standby mode the appliance requires a maximum of 2 W.

- Touch [] to open the menu.
- Touch [Home Connect].
- Touch [Wi-Fi] to switch the wireless module “On” and “Off”.

## Additional settings

Home Connect can be adapted to your individual needs at any time.

Note: The fully automatic coffee machine must be connected to the WLAN network.

## Disconnecting

The fully automatic coffee machine can be disconnected from the WLAN network at any time.

 If the fully automatic coffee machine is disconnected from the WLAN network, it cannot be operated using Home Connect.

- Touch [  ] to open the menu.
- Touch [Home Connect].
- Touch [Disconnect from network].

The connection to the network and app is disconnected. Wi-Fi and remote start are switched off.

 Information about the WLAN network is cleared.

## Connecting with app

The Home Connect app can be installed on any number of mobile devices, which can then be used to connect to the fully automatic coffee machine.

The fully automatic coffee machine must already be connected to the WLAN network.

- Open the app on the mobile device.
- Touch [  ] to open the menu.
- Touch [Home Connect].
- Touch [Connect with app] to connect to the appliance with the app.

## Remote start

If you wish e.g. to start drinks dispensing on the fully automatic coffee machine via a mobile device, Remote start must be activated.



### Risk of burns!

If an unattended remote start takes place, third parties might be scalded if they reach under the coffee dispenser during drinks dispensing. You should therefore make sure that with an unattended remote start that there is no risk to other people, in particular not to children, or to property.



The [Remote start] text field is only visible if connection with Home Connect has been successfully completed.



If Remote start is switched off, only the modes of the fully automatic coffee machine are displayed in the Home Connect app.

- Touch [  ] to open the menu.
- Touch [Home Connect].
- Touch [Remote start] to switch the function Remote start “On” and “Off”.

## Device Info

Display for network and device information

- Touch [  ] to open the menu.
- Touch [Home Connect].
- Touch [applianceInfo]. The SSID, IP, MAC address and serial number of the appliance are displayed for a few seconds.

## Information on data protection

When the fully automatic coffee machine is connected for the first time to a WLAN network which is connected to the Internet, the appliance transmits the following categories of data to the Home Connect server (initial registration):

- Unique appliance identification (consisting of appliance codes as well as the MAC address of the installed Wi-Fi communication module).
- Security certificate of the Wi-Fi communication module (to ensure a secure IT connection).
- The current software and hardware version of the fully automatic coffee machine.
- Status of any previous resetting to the factory settings.

This initial registration prepares the Home Connect functions for use and is only required when you want to use these Home Connect functions for the first time.



Please note that the Home Connect functions can only be used in conjunction with the Home Connect app. Information on data protection can be accessed in the Home Connect app.

## Declaration of Conformity

Robert Bosch Hausgeräte GmbH hereby declares that the appliance which features Home Connect functionality is in accordance with the essential requirements and the other relevant provisions of the directive 1999/5/EC. A detailed R&TTE Declaration of Conformity can be found online at [www.bosch-home.com](http://www.bosch-home.com) among the additional documents on the product page for your appliance.

## Care and daily cleaning



### Risk of electric shock!

Never immerse the appliance in water. Do not steam-clean the appliance.

- Wipe the outside of the appliance with a soft, damp cloth.
- Clean the control panel using a micro-fibre cloth.
- Do not use any cleaning agents containing alcohol or spirits.
- Do not use abrasive cloths or cleaning agents.

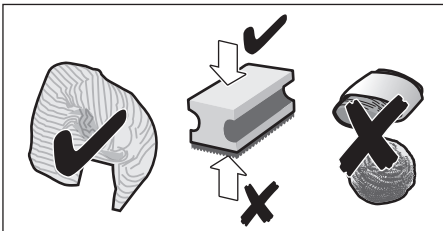

- Always remove any limescale, residues of coffee or milk, cleaning or descaling solution immediately. It is possible for corrosion to form underneath such deposits.



New sponge cloths may contain salts. Salts can cause rust film on stainless steel and must therefore be washed out thoroughly before use.

- Open the door and pull the drip tray out forwards.
- Remove drip tray cover and coffee grounds container.
- Empty, clean and dry individual parts.



**Important:** The drip tray and coffee grounds container should be emptied and cleaned every day in order to prevent deposits.

- Remove the ground coffee drawer, clean under running water and dry well.

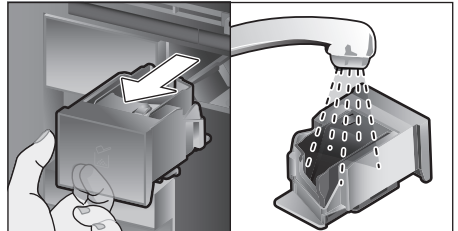

- Wipe and dry the inside of the appliance (support, drip tray and the ground coffee drawer) and collecting tray.
- Replace the dried parts, e.g. the ground coffee drawer.



**Do not put the following parts in the dishwasher:**

Accessory drawer, water tank, lid of the water tank, beverage outlet cover, bean container, lid of the bean container, metal connecting element, ground coffee drawer, protective cover of the brewing unit and the milk container.



**The following parts may be cleaned in the dishwasher:**

Drip plate, collecting tray, drip tray, drip tray cover, coffee grounds container, milk tubes, suction pipes, individual parts of the beverage outlet, measuring spoon and individual parts of the milk container lid.



If the appliance is cold when switched on, or if it is switched off after dispensing coffee, it rinses automatically. The system is therefore self-cleaning.

**Important:** If the appliance is not used for a lengthy period (e.g. while you are on holiday), clean the entire appliance thoroughly, including the milk system, the ground coffee drawer and the brewing unit before use.

## Cleaning the milk system

The milk system is automatically cleaned with a short jet of steam directly after preparing a milk drink.

**i** **Tip:** For particularly thorough cleaning, the milk system can be additionally rinsed with water (see the section “Rinsing the milk system”).

**Important:** Clean the milk system manually every week and, if required, also more often (see the section “Cleaning the milk system manually”).

**⚠** **Risk of burns!**  
The beverage outlet gets very hot. After use, always let it cool down before you touch it.

### Rinsing the milk system

- Touch [ ☉ ].
- Touch [ Rinse milk system ] to select the programme.
- Open door and remove suction pipe from the milk tube.
- Wipe the suction pipe and insert the end of the suction pipe into the hole on the coffee grounds container.

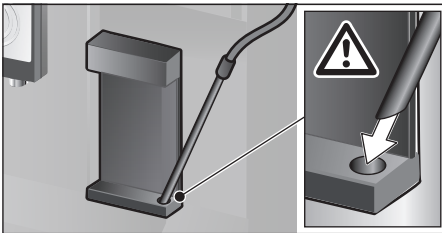

- Close the door. Be careful not to jam the milk tube.
  - Place an empty glass underneath the beverage outlet.
  - Press [ ▷ ].
- The milk system is rinsed with water.
- Then empty the glass.
  - Touch [ ☉ ] to exit the programme.

### Cleaning the milk system manually

Take the milk system apart to clean it:

- Push the beverage outlet down completely and pull the cover forward to remove.
- Press the snap lever to the left of the beverage outlet downwards and pull the beverage outlet forward.

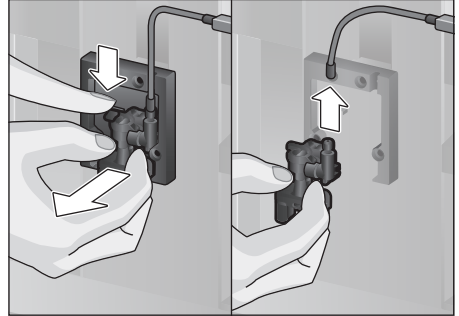

- Remove the milk tube. Dismantle the top and bottom sections of the beverage outlet.

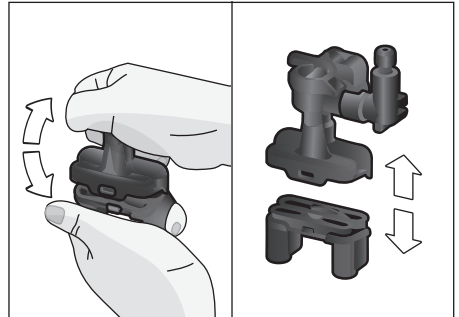

- Separate the milk tubes, connecting element and suction pipe.

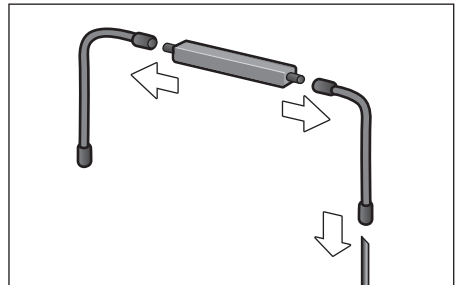

- Clean the individual parts with a detergent solution and a soft cloth.



- Rinse all parts with clean water and dry them.



All parts of the milk system can also be put in the dishwasher.

- Put the individual parts back together again (see also the Quick reference guide).

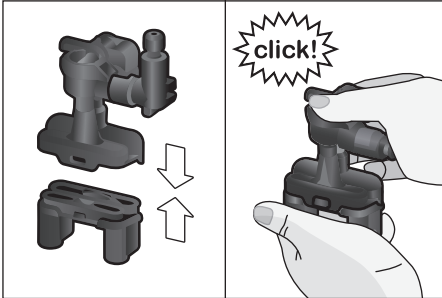

- Attach the beverage outlet directly from the front firmly to the three connections.
- Replace the cover.

## Cleaning the milk container

For reasons of hygiene, the milk container should be cleaned regularly. Only the individual parts of the lid are suitable for being cleaned in the dishwasher. Clean the stainless steel milk container by hand with a mild detergent.

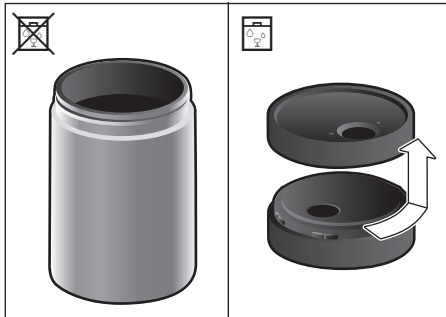

## Cleaning the brewing unit

(see also the Quick reference guide)

In addition to the automatic cleaning programme, the brewing unit should be removed regularly for cleaning.

- Open the appliance door.
- Use the mains switch [ O/I ] to switch off the appliance completely.
- Remove the protective cover of the brewing unit.
- Remove the coffee grounds container.
- Slide the red latch on the brewing unit all the way to the left .
- Press the eject lever right down. The brewing unit will be released.
- Take hold of the brewing unit by the recessed grips and carefully remove it.
- Remove the cover of the brewing unit and clean thoroughly under running water.

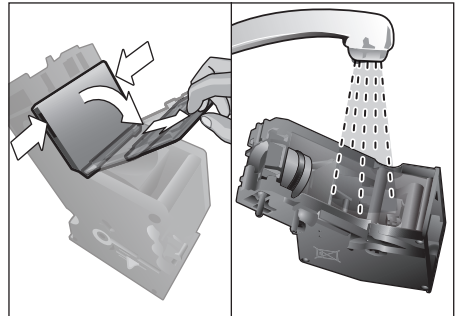

- Clean the strainer of the brewing unit thoroughly under the water jet.

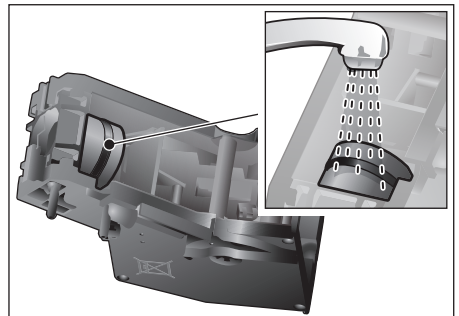

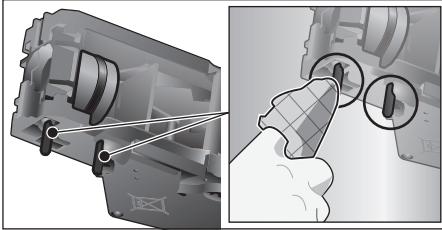

- Thoroughly clean the connecting nozzles of the brewing unit.



 **Important:** Clean it without using washing-up liquid and do not put it in the dishwasher.

- Clean the inside of the appliance thoroughly with a moist cloth, removing any coffee residues.
- Leave the brewing unit and the inside of the appliance to dry.
- Place the cover back on the brewing unit.
- Push the brewing unit all the way into the appliance and press on the middle until it audibly clicks into place.

 **Important:** The red latch must be right over at the left at  before replacing (see diagram E).

- Press the eject lever right up and push the red latch right over to the right to .
- Insert the coffee grounds container.
- Replace the protective cover.
- Close the appliance door.

## Service programmes

(see also the Quick reference guide)

The following messages will appear on the display at certain intervals, either “Descaling programme urgently required!” or “Cleaning programme urgently required!” or “Calc’nClean programme urgently required!”. The unit should immediately be cleaned or descaled using the appropriate programme. Alternatively, the two processes Descale and Clean can be carried out together using the Calc’nClean function (see the section “Calc’nClean”). Failure to carry out the service programme according to the instructions may damage the appliance.

 **Important:** If the appliance is not descaled when it is supposed to be, the message “Descaling programme is overdue. Device will shortly be locked.” will appear. Immediately perform the descaling process in accordance with the instructions. If the appliance is locked, it can only be operated again once the descaling process has been carried out.

To display how many beverages can still be prepared before one of the service programmes needs to be run, proceed as follows:

- Touch [  ].

The service programmes appear. The counter, e.g. “Clean after approx. 28 cups” provides information on when to perform the respective programme next.

 **Warning!** For each of the service programmes, use descaling and cleaning agents as described in the instructions and observe the (relevant) safety information. Never interrupt a service programme. Do not drink liquids! Never use vinegar, citric acid or any vinegar-based or citric acid-based agents. Never place descaling tablets or other descaling materials in the coffee drawer!

**Important:**

Before starting each service program (Descale, Clean or Calc'nClean) remove the brewing unit, clean as instructed and replace it.

Be careful not to jam the milk tube when closing the door.



After completion of each service programme, wipe the appliance immediately with a soft, damp cloth to remove any residues from the descaling and cleaning solution. It is possible for corrosion to form underneath such deposits.

New sponge cloths may contain salts. Salts can cause rust film on stainless steel and must therefore be washed out thoroughly before use. Clean the beverage outlet, milk tubes and connecting piece thoroughly.

Specially developed, suitable descaling and cleaning tablets are available from retail outlets or from customer services (see the section "Accessories").





**Descaling**

Takes about 21 minutes.

- Touch [  ].
- Touch [Descale] to select the programme.
- The display indicates the progress of the programme.
- Empty drip trays and replace.
- Remove the water filter (if there is one) and press [  ].
- Pour lukewarm water into the empty water tank up to the "0.5 l" mark and then dissolve one Bosch descaling tablet TCZ8002 in it.







If there is not enough descaling solution in the water tank, you will be asked to do the following. Refill using uncarbonated water and press [  ] again.

- Remove the suction pipe from milk container, wipe it and insert the end of the suction pipe into the hole on the coffee grounds container.
- Close the appliance door.
- Place a container with a capacity of 0.5 litre under the beverage outlet.
- Press [  ]. The descaling programme will now run for about 19 minutes.
- Remove the container and press [  ].
- Rinse the water tank and (if removed) replace the water filter.
- Fill the tank with fresh water up to the "max" indicator.
- Replace the water tank and close the door.
- Place the container underneath the beverage outlet again.
- Press [  ]. The descaling programme will now run for about 2 minutes and rinse the appliance.
- Remove the container, empty the drip trays, replace and close the appliance door.
- Press [  ]. The appliance has finished descaling and is ready for use again.
- Touch [  ] to exit the program.

**Cleaning**

Takes about 5 minutes.

- Touch [  ].
- Touch [Clean] to select the programme.
- The display indicates the progress of the programme.
- Clean the beverage outlet and replace, empty the drip trays and replace.
- Open the ground coffee drawer, drop in a cleaning tablet and close the coffee drawer again.
- Close the appliance door.
- Place a container with a capacity of 0.5 litre under the beverage outlet.
- Press [  ]. The cleaning programme will now run for about 5 minutes.
- Remove the container, empty the drip trays, replace and close the appliance door.
- Press [  ]. The appliance has finished cleaning and is ready for use again.
- Touch [  ] to exit the program.

## Calc'nClean

Takes about 26 minutes.

Calc'nClean combines the functions Descale and Clean. If both programmes are due to be carried out close together, the fully automatic coffee machine will automatically suggest this service programme.

- Touch [ ☺ ].
- Touch [ Calc'nClean ] to select the programme.
- The display indicates the progress of the programme.
- Clean the beverage outlet and replace, empty the drip trays and replace.
- Open the ground coffee drawer, drop in a cleaning tablet and close the coffee drawer again.
- Remove the water filter (if there is one) and press [ ▷ ]
- Pour lukewarm water into the empty water tank up to the "0.5 l" mark and then dissolve one Bosch descaling tablet TCZ8002 in it.

**i** If there is not enough descaling solution in the water tank, you will be asked to do the following. Refill using uncarbonated water and press [ ▷ ] again.

- Remove the suction pipe from milk container, wipe it and insert the end of the suction pipe into the hole on the coffee grounds container.
- Close the appliance door.
- Place a container with a capacity of 0.5 litre under the beverage outlet.
- Press [ ▷ ]. The programme will now run for about 19 minutes.
- Remove the container and press [ ▷ ].
- Rinse the water tank and (if removed) replace the water filter.
- Fill the tank with fresh water up to the "max" indicator.
- Replace the water tank and close the door.
- Place the container underneath the beverage outlet again.

- Press [ ▷ ]. The programme will now run for about 7 minutes and rinse the appliance.
- Remove the container, empty the drip trays, replace and close the appliance door.
- Press [ ▷ ]. The appliance is descaled, cleaned and ready for use again.
- Touch [ ☺ ] to exit the program.

## Special rinsing

**i Important:** If any of the service programmes is ever interrupted, for instance by a power failure, please proceed according to the information on the display:

- Rinse the water tank and refill it with fresh water up to the "max" mark.
- Press [ ▷ ]. The programme will now run for about 2 minutes and rinse the appliance.
- Empty the drip trays, replace and close the appliance door. The appliance is ready for use again.
- Touch [ ☺ ] to exit the program.

---

## Tips on energy saving

- Press [ Ⓢ ] to switch the appliance to "energy saving mode". The appliances uses very little power when in "energy saving mode", but monitors all safety-relevant functions so as to avoid damage.
- In the menu under "Switch off after", set the automatic switch off period to 15 minutes.
- Reduce the brightness of the display and the illumination in the menu to save energy.
- If possible, do not interrupt the dispensing of coffee or milk froth. Stopping a process prematurely results in higher energy consumption and the drip tray fills up more quickly.
- Descale the appliance regularly to avoid a build-up of limescale. Limescale residues cause higher energy consumption.

---

## Frost protection

To prevent frost damage during transport and storage, completely empty the appliance beforehand (see the section “Menu – Frost protection”).

---

## Storing accessories

The fully automatic coffee machine has a special accessory drawer for storing the Quick reference guide and the accessories in the appliance.

- Put the measuring spoon and the water filter into the accessory drawer.
- Put the Quick Reference Guide into the special support at the front of the accessory drawer.
- The long suction pipe can be stored in the holder on the inside of the door.
- The connecting element can be fixed to the magnetic holder above the ground coffee drawer.

---

## Accessories

The following accessories are available from retailers or from customer service:

Accessories	Order number
	Customer service
Cleaning tablets	00311808
Descaling tablets	00576694
Water filter	00575491
Care set	00576331
Milk container with “FreshLock” lid	00576165
Restrictors for opening angle 92°	00636455

---

## Disposal



Dispose of packaging in an environmentally-friendly manner. This appliance is labelled in accordance with European Directive 2012/19/EU concerning used electrical and electronic appliances (waste electrical and electronic equipment – WEEE). The guideline determines the framework for the return and recycling of used appliances as applicable throughout the EU. Please ask your specialist retailer about current disposal facilities.

---

## Guarantee

The guarantee conditions for this appliance are as defined by our representative in the country in which it is sold. Details regarding these conditions can be obtained from the dealer from whom the appliance was purchased. The bill of sale or receipt must be produced when making any claim under the terms of this guarantee.

Changes reserved.

## Simple troubleshooting

Problem	Cause	Solution
Strongly fluctuating coffee or milk froth quality (e.g. fluctuation in quantity or milk froth spraying).	Build-up of limescale in the appliance.	Descalc the appliance according to the instructions, see the section "Service programmes".
	The suction pipe is blocked.	Clean the suction pipe.
Drinks cannot be dispensed.	Beverage outlet or one of the 3 connections are blocked.	Clean the beverage outlet and the connections.
The drink runs out at the entire outlet during dispensing.	Lower part of the beverage outlet is missing.	Attach the lower part, see the section "Cleaning the milk system".
Too little milk froth, none at all, or the milk system is not taking in any milk.	Build-up of limescale in the appliance.	Descalc the appliance according to the instructions, see the section "Service programmes".
	Beverage outlet or one of the 3 connections are blocked.	Clean the beverage outlet and the connections.
	Milk not suitable for foaming.	Do not use milk that has already been boiled. Use cold milk with a fat content of at least 1.5%.
	Beverage outlet or the milk tubes are not correctly assembled.	Moisten the individual parts and put them together again.
	The suction pipe is blocked.	Clean the suction pipe.
The personally selected volume is not reached. Coffee dispensing slows to a trickle or stops completely.	Coffee is ground too finely. Preground coffee is too fine.	Adjust the grinding level to a coarser setting. Use a coarser ground coffee.
	Heavy build-up of limescale in the appliance.	Descalc the appliance according to the instructions, see the section "Service programmes".
	The brewing unit is soiled.	Clean brewing unit, see chapter "Cleaning the brewing unit".
Hot water milky or tastes of coffee.	Milk tube has not been removed.	Remove the milk tube from the milk container.
	Milk or coffee residue in the beverage outlet.	Clean the beverage outlet.
Coffee has no "crema".	Unsuitable type of coffee.	Use a type of coffee with a higher proportion of robusta beans.
	The beans are no longer fresh.	Use fresh beans.
	The grinding level is not suitable for the beans.	Adjust the grinding unit to a finer setting.

<b>Problem</b>	<b>Cause</b>	<b>Solution</b>
Coffee is too "acidic".	The grinding level is too coarse. Preground coffee is too coarse.	Adjust the grinding unit to a finer setting. Use a finer ground coffee.
	Unsuitable type of coffee.	Change the type of coffee.
Coffee is too "bitter".	Coffee is ground too finely. Preground coffee is too fine.	Adjust the grinding level to a coarser setting. Use a coarser ground coffee.
	Unsuitable type of coffee.	Change the type of coffee.
Coffee tastes burnt.	The brewing temperature is too high.	Reduce the temperature, see the section "Drink adjustment".
	Coffee is ground too finely. Preground coffee is too fine.	Adjust the grinding level to a coarser setting. Use a coarser ground coffee.
	Unsuitable type of coffee.	Change the type of coffee.
Coffee is too "weak".	Coffee strength selected is too weak.	Raise the strength of the coffee, see the section "Drink adjustment".
	Ground coffee jammed in the coffee drawer.	Remove the ground coffee drawer, clean and dry thoroughly.
Ground coffee sticks in the coffee drawer.	Ground coffee sticks together.	Do not press the ground coffee firmly into the coffee drawer.
	Coffee drawer is damp.	Remove the ground coffee drawer, clean and dry thoroughly.
The water filter does not stay in position in the water tank.	The water filter is not mounted correctly.	Firmly press the water filter straight down into the tank connection.
Bean container sticks when inserting.	There are beans in the housing.	Remove the beans.
The coffee grounds are not compact and are too wet.	The grinding setting is too fine or too coarse, or not enough ground coffee has been used.	Adjust the grinding unit to a coarser or finer setting, or use 2 level measuring spoons of ground coffee.
Grinding level adjustment is stiff.	Too many beans in the grinding unit.	Dispensing a drink from coffee beans. Only make any subsequent changes to the grinding level in small steps.

<b>Problem</b>	<b>Cause</b>	<b>Solution</b>
Brewing unit cannot be inserted.	Brewing unit is in the wrong position.	Insert the brewing unit according to the instructions, see the section “Cleaning the brewing unit”.
	Brewing unit is locked.	Unlock the brewing unit, see the section “Cleaning the brewing unit”.
Protective cover of the brewing unit cannot be properly attached.	Brewing unit is not locked.	Lock the brewing unit, see the section “Cleaning the brewing unit”.
There is water under the drip tray.	This water is condensed.	Do not insert drip tray without cover.
Display shows “12:00”	Power failure or appliance switched off at mains.	Re-enter values; do not switch the appliance off at the mains or select the “off” option in the Clock displ. menu.
Display shows “Milk container connected?” despite connected milk container.	Container is outside the range of the sensor.	Position the container at the right edge.
	Material e.g. milk carton is not recognised.	Confirm the display request with “Yes” or use the enclosed milk container.
Display shows “Overvoltage or undervoltage”	Voltage too high or too low.	Contact electricity or grid provider. Have the power supply checked by an expert.
Display shows “Leave device to cool”	Appliance is too hot.	Switch off appliance for 30 minutes.
Display shows, for example: “Fault: E0510”	The appliance has a fault.	Proceed according to the display screen.
Display shows “Fill bean container” although the container is already full, or the grinder is not grinding any beans.	Beans are not falling into the grinding unit (beans too oily).	Gently tap the bean container. Possibly change the type of coffee. When the bean container is empty, wipe it with a dry cloth.
Display shows “Clean brewing unit”	Brewing unit is soiled.	Clean the brewing unit.
	Too much ground coffee in the brewing unit.	Clean the brewing unit. Do not place more than two level measuring spoons of ground coffee in the drawer.
	The mechanism of the brewing unit is stiff.	Clean the brewing unit, see the section “Care and daily cleaning”.



<b>Problem</b>	<b>Cause</b>	<b>Solution</b>
Display shows "Refill with still water or remove filter"	Water tank wrongly inserted	Insert water tank correctly
	Carbonated water in the water tank.	Fill the water tank with fresh tap water.
	Float is stuck in the water tank.	Remove the tank and clean thoroughly.
	New water filter not rinsed according to instructions, or water filter used or defective.	Rinse the water filter according to the instructions and then switch on, or use a new water filter.
	Air in the water filter.	Dip the water filter into water until no more air bubbles escape, replace the filter.
Display shows "Empty drip trays" despite them being empty.	Drip tray is soiled and wet.	Clean and dry the drip tray thoroughly.
	Emptying is not detected when the appliance is switched off.	When the appliance is switched on, remove and re-insert the drip tray.
Display shows "Insert drip trays" even though drip tray in use.	Inside of appliance (tray holder) dirty.	Clean the inside.
	The coffee grounds container is not fully inserted.	Push the coffee grounds container all the way in.
Water dripped onto the inner floor of the appliance when the drip tray was removed.	Drip tray was removed too soon.	Wait a few seconds after the last drink was dispensed before removing the drip tray.
Display shows "Switch off with power switch, then back on after 30 sec!"	Appliance is too warm.	Leave the appliance to cool down.
	Dirty brewing unit.	Clean the brewing unit.
Home Connect does not work correctly.		Go to <a href="http://www.home-connect.com">www.home-connect.com</a>

**If you are unable to solve the problem, always call the hotline!  
You will find the telephone numbers at the back of these instructions.**

## Technical specifications

Power connection (voltage – frequency)	220-240 V – 50/60 Hz
Power rating	1600 W
Maximum static pump pressure	19 bar
Maximum water tank capacity (without filter)	2.4 l
Maximum capacity of the coffee bean container	500 g
Length of power cable	1.7 m
Dimensions (H x B x D)	455 x 495 x 375 mm
Weight, empty	19-20 kg
Type of grinding unit	Ceramic

**DE Deutschland, Germany**

BSH Hausgeräte Service GmbH  
Zentralwerkstatt für kleine Hausgeräte  
Trautskirchner Strasse 6-8  
90431 Nürnberg

Online Auftragsstatus, Pickup Service  
für Kaffeefullautomaten und viele  
weitere Infos unter:  
www.bosch-home.com

Reparaturservice, Ersatzteile &  
Zubehör, Produkt-Informationen:  
Tel.: 0911 70 440 040  
mailto:cp-servicecenter@bshg.com  
Wir sind an 365 Tagen rund um die Uhr  
erreichbar.

**AE United Arab Emirates,  
الإمارات العربية المتحدة**

BSH Home Appliances FZE  
Round About 13,  
Plot Nr MO-0532A  
Jebel Ali Free Zone – Dubai  
Tel.: 04 881 4401  
mailto:service.uae@bshg.com  
www.bosch-home.com/ae

**AL Republika e Shqiperise,  
Albania**

ELEKTRO-SERVIS sh.p.k  
Rr. Shkelqim Fusha, Selite,  
Pallati "Matrix Konstruktion",  
Kati 0 dhe +1  
1023 Tirane  
Tel.: 4 2278 130, -131  
Fax: 4 2278 130  
mailto:info@elektro-servis.com

EXPERT SERVIS  
Rruga e Kavajes,  
Kulla B Nr 223/1 Kati I  
1023 Tirane  
Tel.: 4 480 6061  
Tel.: 4 227 4941  
Fax: 4 227 0448  
Cel: +355 069 60 45555  
mailto:info@expert-servis.al

**AT Österreich, Austria**

BSH Hausgeräte Gesellschaft mbH  
Werkskundendienst für Hausgeräte  
Quellenstrasse 2a  
1100 Wien

Online Reparaturannahme,  
Ersatzteile und Zubehör und viele  
weitere Infos unter:  
www.bosch-home.at

Reparaturservice, Ersatzteile &  
Zubehör, Produktinformationen  
Tel.: 0810 550 511  
mailto:vie-stoerungsannahme@  
bshg.com

Wir sind an 365 Tagen rund um die Uhr für  
Sie erreichbar.

**AU Australia**

BSH Home Appliances Pty. Ltd.  
Gate 1, 1555 Centre Road  
Clayton, Victoria 3168  
Tel.: 1300 369 744\*  
Fax: 1300 306 818  
mailto:aftersales.au@bshg.com  
www.bosch-home.com.au  
\*Mo-Fr: 24 hours

**BA Bosna i Hercegovina,  
Bosnia-Herzegovina**

"HIGH" d.o.o.  
Gradačanka 29b  
71000 Sarajevo  
Tel.: 061 10 09 05  
Fax: 033 21 35 13  
mailto:bosch\_siemens\_sarajevo@  
yahoo.com

**BE Belgique, België, Belgium**

BSH Home Appliances S.A.  
Avenue du Laerbeek 74  
Laarbeeklaan 74  
1090 Bruxelles – Brussel  
Tel.: 070 222 141  
Fax: 024 757 291  
mailto:bru-repairs@bshg.com  
www.bosch-home.be

**BG Bulgaria**

BSH Domakinski Uredi  
Bulgaria EOOD  
115K Tsarigradsko Chausse Blvd.  
European Trade Center Building,  
5th floor  
1784 Sofia  
Tel.: 0700 208 17  
Fax: 02 878 79 72  
mailto:informacia.servis-bg@  
bshg.com  
www.bosch.home.bg

**BH Bahrain, البحرين**

Khalalifat Est.  
P.O. Box 5111  
Manama  
Tel.: 01 7400 553  
mailto:service@khalalifat.com

**BY Belarus, Беларусь**

ООО "БХХ Бытовая техника"  
тел.: 495 737 2961  
mailto:mok-kdhl@bshg.com

**CH Schweiz, Suisse,  
Svizzera, Switzerland**

BSH Hausgeräte AG  
Werkskundendienst für Hausgeräte  
Fahrweidstrasse 80  
8954 Geroldswil  
mailto:ch-info.hausgeraete@  
bshg.com

Service Tel.: 0848 840 040  
Service Fax: 0848 840 041  
mailto:ch-reparatur@bshg.com  
Ersatzteile Tel.: 0848 880 080  
Ersatzteile Fax: 0848 880 081  
mailto:ch-ersatzteil@bshg.com  
www.bosch-home.com

**CY Cyprus, Κύπρος**

BSH Ikiakes Syskeves-Service  
39, Arh. Makaanariou III Str.  
2407 Egomi/Nikosia (Lefkosia)  
Tel.: 7777 8007  
Fax: 022 658 128  
mailto:bsh.service.cyprus@  
cytanet.com.cy

**CZ Česká Republika,  
Czech Republic**

BSH domácí spotřebiče s.r.o.  
Firemní servis domácích spotřebičů  
Pekařská 10b  
155 00 Praha 5  
Tel.: 0251 095 546  
Fax: 0251 095 549  
www.bosch-home.com/cz

**DK Danmark, Denmark**

BSH Hvidevarer A/S  
Telegrafvej 4  
2750 Ballerup  
Tel.: 44 89 89 85  
Fax: 44 89 89 86  
mailto:BSH-Service-DK@BSHG.com  
www.bosch-home.dk

**EE Eesti, Estonia**

SIMSON OÜ  
Raua 55  
10152 Tallinn  
Tel.: 0627 8730  
Fax: 0627 8733  
mailto:teenindus@simson.ee

**ES España, Spain**

En caso de avería puede ponerse en  
contacto con nosotros, su aparato  
será trasladado a nuestro taller  
especializado de cafeteras.  
BSH Electrodomésticos España S.A.  
Servicio Oficial del Fabricante  
Parque Empresarial PLAZA,  
C/ Manfredonia, 6  
50197 Zaragoza  
Tel.: 902 245 255 o 976 305 713  
Fax: 976 578 425  
mailto:CAU-Bosch@bshg.com  
www.bosch-home.es

**FI Suomi, Finland**

BSH Kodinkoneet Oy  
Itälahdenkatu 18 A, PL 123  
00201 Helsinki  
Tel.: 0207 510 700  
Fax: 0207 510 780  
mailto: Bosch-Service-FI@bshg.com  
www.bosch-home.fi  
Lankapuhelimesta 8,28 snt/puhelu  
+ 7 snt/min (alv 24%)  
Matkapuhelimesta 8,28 snt/puhelu  
+ 17 snt/min (alv 24%)

**FR France**

BSH Electroménager S.A.S.  
50 rue Ardoin – CS 50037  
93406 SAINT-OUEN cedex  
Service interventions à domicile:  
01 40 10 11 00  
Service Consommateurs:  
0892 698 110   
mailto:soa-bosch-conso@bshg.com  
Service Pièces Détachées et  
Accessoires:  
0 892 698 009 

www.bosch-home.fr

**GB Great Britain**

BSH Home Appliances Ltd.  
Grand Union House  
Old Wolverton Road  
Wolverton  
Milton Keynes MK12 5PT  
To arrange an engineer visit, to order  
spare parts and accessories or for  
product advice please visit  
www.bosch-home.co.uk  
or call  
Tel.: 0344 892 8979\*  
\*Calls are charged at the basic rate, please  
check with your telephone service provider for  
exact charges

**GR Greece, Ελλάς**

BSH Ikiakes Siskeves A.B.E.  
Central Branch Service  
17 km E.O. Athinon-Lamias &  
Potamou 20  
14564 Kifisia  
Πανελλήνιο τηλέφωνο: 181 82  
(Αστική χρέωση)  
mailto:nkf-CustomerService@bshg.com  
www.bosch-home.gr

**HK Hong Kong, 香港**

BSH Home Appliances Limited  
Unit 1 & 2, 3rd Floor,  
North Block, Skyway House,  
3 Sham Mong Road  
Tai Kok Tsui, Kowloon  
Hong Kong  
Tel.: 2565 6151  
Fax: 2565 6681  
mailto:bosch.hk.service@bshg.com  
www.bosch-home.cn

**HR Hrvatska, Croatia**

BSH kućni uređaji d.o.o.  
Kneza Branimira 22  
10000 Zagreb  
Tel.: 01 552 08 88  
Fax: 01 640 36 03  
mailto:informacije.servis-hr@  
bshg.com  
www.bosch-home.com/hr

**HU Magyarország, Hungary**

BSH Háztartási Készülék  
Kereskedelmi Kft.  
Háztartási gépek márkaszervize  
Királyhágó tér 8-9.  
1126 Budapest  
Hibabejelentés  
Tel.: +361 489 5461  
Fax: +361 201 8786  
mailto:hibabejelentes@bsh.hu  
Alkatrészrendelés  
Tel.: +361 489 5463  
Fax: +361 201 8786  
mailto:alkatreszrendeles@bsh.hu  
www.bosch-home.com/hu

**IE Republic of Ireland**

BSH Home Appliances Ltd.  
Unit F4, Ballymount Drive  
Ballymount Industrial Estate  
Walkinstown  
Dublin 12  
Service Requests, Spares and  
Accessories  
Tel.: 01450 2655\*  
Fax: 01450 2520  
www.bosch-home.co.uk  
\*0.03 € per minute at peak.  
Off peak 0.0088 € per minute.

**IL Israel, יִשְׂרָאֵל**

C/S/B/ Home Appliance Ltd.  
1, Hamasger St.  
North Industrial Park  
Lod, 7129801  
Tel.: 08 9777 222  
Fax: 08 9777 245  
mailto:csb-serv@csb-ltd.co.il  
www.bosch-home.co.il

**IN India, Bhārat, भारत**

BSH Household Appliances  
Mfg. Pvt. Ltd.  
Arena House, 2nd Floor, Main Bldg.  
Plot No. 103, Road No. 12,  
MIDC, Andheri East  
Mumbai 400 093  
Toll Free 1800 266 1880\*  
www.bosch-home.com/in  
\*Mo-Sa: 8.00am to 8.00pm  
(exclude public holidays)

**IS Iceland**

Smith & Norland hf.  
Noatuni 4  
105 Reykjavik  
Tel.: 0520 3000  
Fax: 0520 3011  
www.sminor.is

**IT Italia, Italy**

BSH Elettrodomestici S.p.A.  
Via. M. Nizzoli 1  
20147 Milano (MI)  
Numero verde 800 829 120  
mailto:info.it@bosch-home.com  
www.bosch-home.com/it

**KZ Kazakhstan, Қазақстан**

IP Turebekov Yerzhan  
Nurmanovich  
Jangeldina str. 15  
Shimkent 160018  
Tel.: 0252 31 00 06  
mailto:evrika\_kz@mail.ru

**LB Lebanon, لبنان**

Teheni, Hana & Co.  
Boulevard Dora 4043 Beyrouth  
P.O. Box 90449  
Jdeideh, 1202 2040  
Tel.: 01 255 211  
mailto:info@Teheni-Hana.com

**LT Lietuva, Lithuania**

Senuku prekybos centras UAB  
Jonavos g. 62  
44192 Kaunas  
Tel.: 0372 12146  
Fax: 0372 12165  
www.senukai.lt

**LU Luxembourg**

BSH électroménagers S.A.  
13-15, ZI Bredeweues  
1259 Senningerberg  
Tel.: 26349 300  
Fax: 26349 315  
Reparaturen: lux-repair@bshg.com  
Ersatzteile: lux-spare@bshg.com  
www.bosch-home.com/lu

**LV Latvija, Latvia**

General Serviss Limited  
Bullu street 70c  
1067 Riga  
Tel.: 07 42 41 37  
mailto:bt@olimpex.lv

**MD Moldova**

S.R.L. "Rialto-Studio"  
ул. Щусева 98  
2012 Кишинев  
тел./факс: 022 23 81 80  
mailto:bosch-md@mail.ru

**ME Crna Gora, Montenegro**

Elektronika komerc  
Ul. Slobode 17  
84000 Bijelo Polje  
Tel./Fax: 050 432 575  
Mobil: 069 324 812  
mailto:ekobosch.servis@t-com.me

**MK Macedonia, Македонија**  
GORENEC  
Jane Sandanski 69 lok. 3  
1000 Skopje  
Tel.: 022 454 600  
Mobil: 070 697 463  
mailto:gorenec@yahoo.com

**MT Malta**  
Oxford House Ltd.  
Notabile Road  
Mriehel BKR 14  
Tel.: 021 442 334  
Fax: 021 488 656  
www.oxfordhouse.com.mt

**MV Raajjeyge Jumhooriyyaa, Maldives**  
Lintel Investments  
Ma. Maadheli, Majeedhee Magu Malé  
Tel.: 0331 0742  
mailto:mohamed.zuhuree@lintel.com.mv

**NL Nederlande, Netherlands**  
BSH Huishoudapparaten B.V.  
Taurusavenue 36  
2132 LS Hoofddorp  
Storingsmelding:  
Tel.: 088 424 4010  
Fax: 088 424 4845  
mailto:bosch-contactcenter@bshg.com  
Onderdelenverkoop:  
Tel.: 088 424 4010  
Fax: 088 424 4801  
mailto:bosch-onderdelen@bshg.com  
www.bosch-home.nl

**NO Norge, Norway**  
BSH Husholdningsapparater A/S  
Grensevingen 9  
0661 Oslo  
Tel.: 22 66 06 00  
Fax: 22 66 05 50  
mailto:Bosch-Service-NO@bshg.com  
www.bosch-home.no

**NZ New Zealand**  
BSH Home Appliances Ltd.  
Unit F2, 4 Orbit Drive  
Mairangi Bay  
Auckland 0632  
Tel.: 0800 245 700\*  
Fax: 0800 256 535  
mailto:repairaction.nz@bshg.com  
www.bosch-home.co.nz  
\* Mo-Fr: 8.30am to 4.00pm  
(exclude public holidays)

**PL Polska, Poland**  
BSH Sprzęt Gospodarstwa  
Domowego sp. z o.o.  
Al. Jeruzolimskie 183  
02-222 Warszawa  
Tel.: 801 191 534  
Fax: 022 572 7709  
mailto:Serwis.Fabryczny@bshg.com  
www.bosch-home.pl

**PT Portugal**  
BSHP Electrodomésticos,  
Sociedade Unipessoal, Lda.  
Rua Alto do Montijo, nº 15  
2790-012 Carnaxide  
Tel.: 214 250 730  
Fax: 214 250 701  
mailto:bosch.electrodomesticos.pt@bshg.com  
www.bosch-home.pt

**RO România, Romania**  
BSH Electrocasnice srl.  
Sos. Bucuresti-Ploiesti,  
nr. 19-21, sect.1  
13682 Bucuresti  
Tel.: 021 203 9748  
Fax: 021 203 9733  
mailto:service.romania@bshg.com  
www.bosch-home.ro

**RU Russia, Россия**  
ООО "БСХ Бытовая техника"  
Сервис от производителя  
Малая Калужская 19/1  
119071 Москва  
тел.: 495 737 2961  
mailto:mok-kdhl@bshg.com  
www.bosch-home.com

**SA Kingdom Saudi Arabia,**  
المملكة العربية السعودية  
Abdul Latif Jameel Electronics  
and Airconditioning Co. Ltd.  
BOSCH Service centre,  
Kilo 5 Old Makkah Road  
(Next to Toyota), Jamiah Dist.  
P.O.Box 7997  
Jeddah 21472  
Tel.: 800 244 0043  
mailto:kunnumalsp@alj.com  
www.aljelectronics.com.sa

**SE Sverige, Sweden**  
BSH Home Appliances AB  
Landsvägen 32  
169 29 Solna  
Tel.: 0771 11 22 77 local rate  
mailto:Bosch-Service-SE@bshg.com  
www.bosch-home.se

**SG Singapore, 新加坡**  
BSH Home Appliances Pte. Ltd.  
Block 4012, Ang Mo Kio Avenue 10  
#01-01 Techplace 1  
Singapore 569628  
Tel.: 6751 5000\*  
Fax: 6751 5005  
mailto:bshsgp.service@bshg.com  
www.bosch-home.com.sg  
\* Mo-Fr: 8.30am to 7.00pm, Sa: 8.30am to 5.30pm  
(exclude public holidays)

**SI Slovenija, Slovenia**  
BSH Hišni aparati d.o.o.  
Litostrojska 48  
1000 Ljubljana  
Tel.: 01 583 07 00  
Fax: 01 583 08 89  
mailto:informacije.servis@bshg.com  
www.bosch-home.com/si

**SK Slovensko, Slovakia**  
BSH domácí spotřebiče s.r.o.  
Organizačná zložka Bratislava  
Galvaniho 17/C  
821 04 Bratislava  
Tel.: 02 44 45 20 41  
mailto:opravy@bshg.com  
www.bosch-home.com/sk

**TR Türkiye, Turkey**  
BSH Ev Aletleri Sanayi  
ve Ticaret A. S.  
Fatih Sultan Mehmet Mahallesi  
Balkan Caddesi No: 51  
34771 Ümraniye, Istanbul  
Tel.: 0 216 444 6333\*  
Fax: 0 216 528 9188\*  
mailto:careline.turkey@bshg.com  
www.bosch-home.com/tr  
\* Çağrı merkezini sabit hatlardan  
aramanın bedeli şehir içi ücretlendirime,  
Çep telefonlarından ise kullanılan  
tarifeye göre değişkenlik göstermektedir

**TW Taiwan, 台湾**  
我們期盼您不斷的鼓勵與指導，  
任何諮詢或服務需求，  
歡迎洽詢客服專線  
BSH Home Appliances Private Limited  
台北市內湖區洲子街80號11樓  
11F., No.80, Zhouzi St., Neihu Dist.  
Taipei City 11493  
Tel.: 0800 368 888  
Fax: 02 2627 9788  
mailto:bshstzn-service@bshg.com  
www.bosch-home.com.tw

**UA Ukraine, Україна**  
ТОВ "БСХ Побутова Техніка"  
тел.: 044 490 2095  
mailto:bsh-service.ua@bshg.com  
www.bosch-home.com.ua

**XK Kosovo**  
NTP GAMA  
Rruga Mag Prishtine-Ferizaj  
70000 Ferizaj  
Tel.: 0290 321 434  
mailto:a\_service@gama-electronics.com

**XS Srbija, Serbia**  
BSH Kućni aparati d.o.o.  
Milutina Milanovića br. 9ž  
11070 Novi Beograd  
Tel.: 011 353 70 08  
Fax: 011 205 23 89  
mailto:informacije.servis-sr@bshg.com  
www.bosch-home.rs

**ZA South Africa**  
BSH Home Appliances (Pty) Ltd.  
15th Road Randjespark  
Private Bag X36, Randjespark  
1685 Midrand – Johannesburg  
Tel.: 086 002 6724  
Fax: 086 617 1780  
mailto:appliance-service.za@bshg.com  
www.bosch-home.com/za

## Service-Hotlines

---

[www.bosch-home.com](http://www.bosch-home.com)

<b>AE</b>	04 803 0500	<b>ME</b>	050 432 575
<b>AL</b>	066 206 47 94	<b>MK</b>	02 2454 600
<b>AT</b>	0810 550 511	<b>NL</b>	088 424 4010
<b>AU</b>	1300 368 339	<b>NO</b>	22 66 06 00
<b>BA</b>	033 213 513	<b>PL</b>	801 191 534
<b>BE</b>	070 222 141	<b>PT</b>	21 4250 730
<b>BG</b>	02 931 50 62	<b>RO</b>	021 203 9748
<b>CH</b>	043 455 4095	<b>RU</b>	8 800 200 29 61
<b>CN</b>	400 885 5888 Call rates depend on the network used	<b>SE</b>	0771 11 22 77 (local rate)
<b>CZ</b>	0251 095 546	<b>SK</b>	02 444 520 41
<b>DE</b>	0911 70 440 040	<b>SL</b>	01 200 70 17
<b>DK</b>	44 89 89 85	<b>TR</b>	444 6333 Çağrı merkezini sabit hatlardan aramanın bedeli şehir içi ücretlendirme, Cep telefonlarından ise kullanılan tarifeye göre değişkenlik göstermektedir
<b>EE</b>	0627 8730	<b>US</b>	800 944 2904 (toll free)
<b>ES</b>	902 24 52 55	<b>XK</b>	044 172 309
<b>FI</b>	020 7510 700 Lankapuhelimesta 8,28 snt/puhelu + 7 snt/min (alv 24%) Matkapuhelimesta 8,28 snt/puhelu + 17 snt/min (alv 24%)	<b>XS</b>	011 21 39 552
<b>FR</b>	0140 10 1100		
<b>GB</b>	0344 892 8979 Calls charged at local or mobile rate		
<b>GR</b>	18 182 (αστική χρέωση)		
<b>HR</b>	01 3028 226		
<b>HU</b>	00361 489 5461		
<b>IE</b>	01450 2655 0.03 € per minute at peak. Off peak 0.0088 € per minute.		
<b>IL</b>	08 9777 222		
<b>IS</b>	0520 3000		
<b>IT</b>	800 829 120 (Line Verde)		
<b>LI</b>	05 274 1788		
<b>LU</b>	26 349 300		
<b>LV</b>	067 425 232		





**Robert Bosch Hausgeräte GmbH**  
**Carl-Wery-Straße 34**  
**81739 München, GERMANY**  
**[www.bosch-home.com](http://www.bosch-home.com)**



**8001051473**

961104